



IRIMO



CATALOGUE 2022

**Uranusz**

Szerszám Kereskedőház Kft.
1103 Budapest, Noszlopy u. 16/b.
Telefon: +36 1 260 30 30
www.uranusz.hu

Szerszámban a mérce®

90

MORE THAN

YEARS OF HISTORY IS JUST THE BEGINNING

Everything started back in the 30's in the Basque Country sited in a small village in the Northern part of Spain. We used to manufacture cart axles and mill balls for cement factories. Decade after decade, we forged our innovative heritage by launching tools such as side nut adjustable wrench, so imitated over the recent years.

Today, we keep our commitment to continuous improvement adapting to the needs of professionals who appreciate their toolbox.



IRIMO

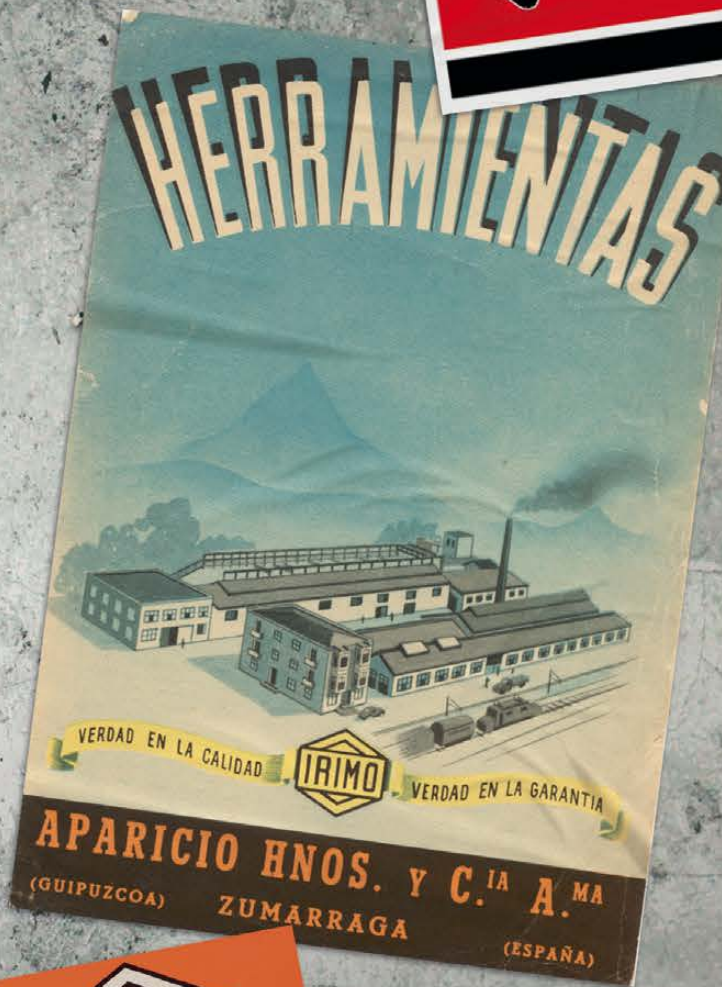

IRIMO

THE ORIGIN IS IMPORTANT DESTINY IS EVEN MORE

WE WANT TO BE WHERE YOU NEED US.
THUS, OUR PRESENCE IS WIDENING EVERYDAY.

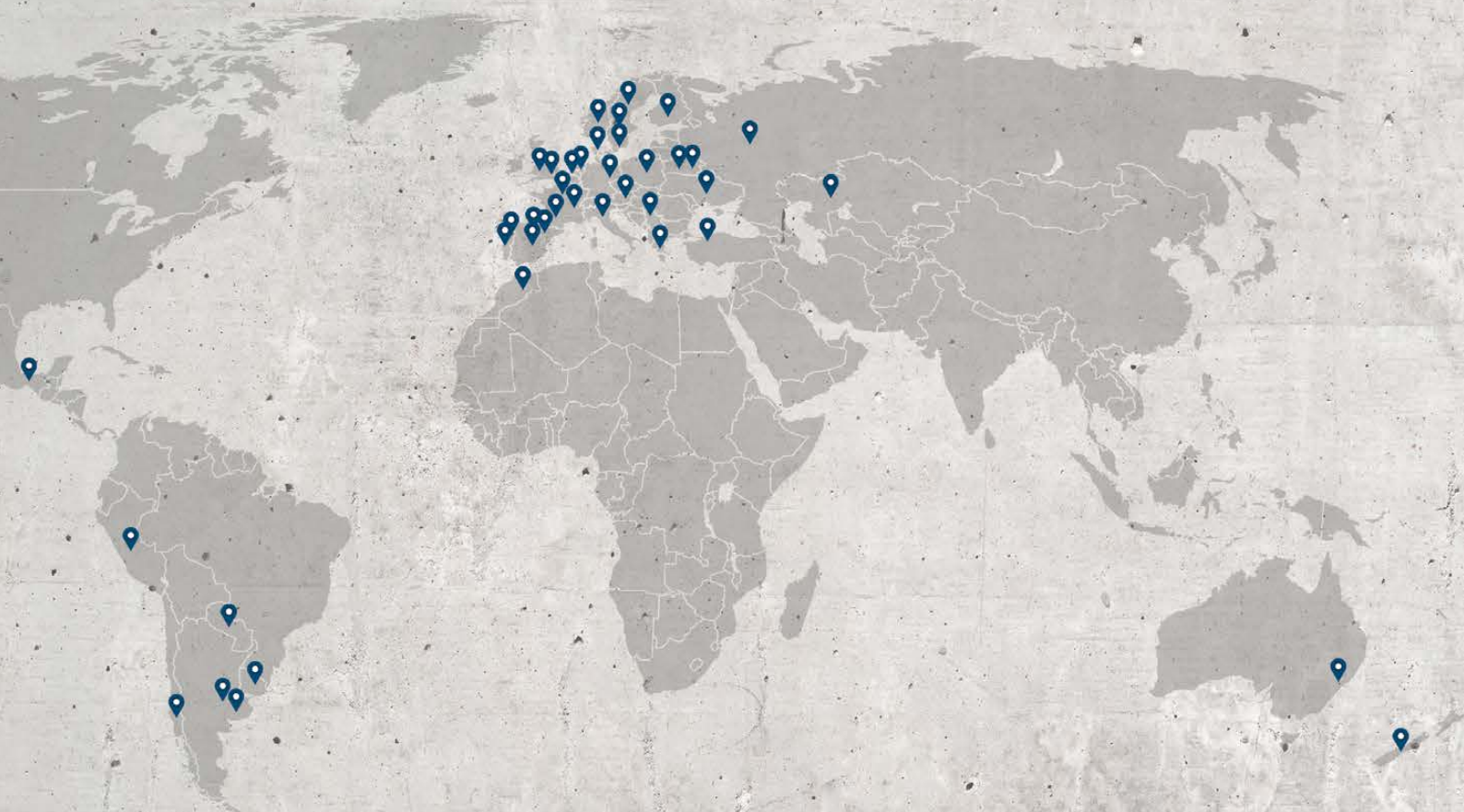

 AUSTRALIA & NZ

 BELGIUM

 CHILE

 DENMARK

 FINLAND

 FRANCE

 GERMANY

 GREECE

 ITALY

 NORWAY

 POLAND

 PORTUGAL

 RUSSIA

 SPAIN

 SWEDEN

 SWITZERLAND

 THE NETHERLANDS

 TURKEY

VISIT OUR NEW WEBSITE WWW.IRIMO.COM

- EVERYTHING YOU NEED TO KNOW FROM US
- SELF EXPLANATORY PICTURES
- COMPLETE INFORMATION ABOUT NEW PRODUCTS
- DOWNLOAD PDF OF EACH PRODUCT
- SOCIAL MEDIA FEED
- WHERE TO BUY

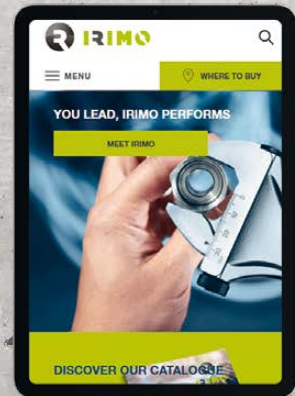
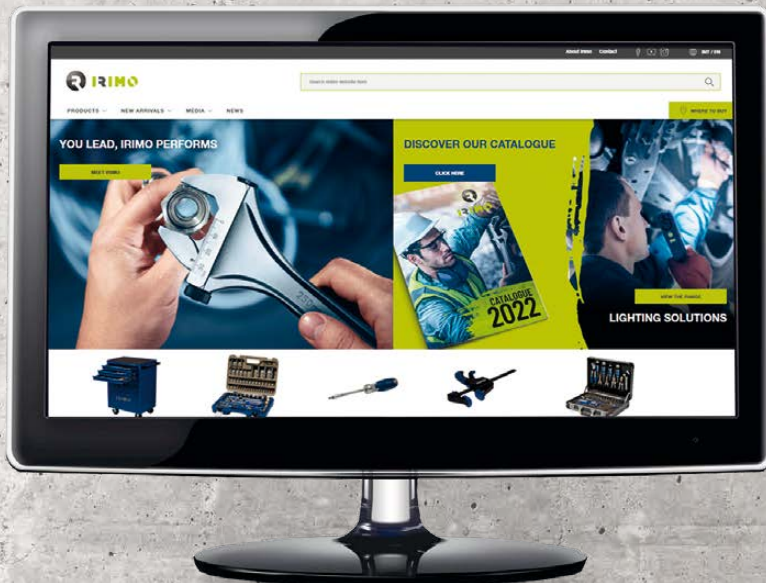

- ➔ INDEX 4-12
- ➔ ALPHANUMERICAL INDEX 192-204
- ➔ WARRANTY 209

TOOL INDEX

1. TOOL STORAGE

13



2. WRENCHES

35



3. TORQUE TOOLS

51



4. SOCKETRY

55



5. CLAMPING TOOLS

85



6. PIPE TOOLS

93



7. SCREWDRIVERS & BITS

99



8. STRIKING TOOLS

133



10. PULLING TOOLS

163



9. PLIERS - SCISSORS AND KNIVES

145



11. CUTTING TOOLS AND MEASURING

169



12. LIGHTING AND POWER TOOLS

181



01. TOOL STORAGE	13-34
TOOL TROLLEYS	14-17
5 DRAWER TOOL TROLLEY	14
6 DRAWER TOOL TROLLEY	14
7 DRAWER TOOL TROLLEY	14
4 DRAWER TOP CHEST	14
TROLLEY 6 DRAWERS WITH FOAM AND TOOLS	15-16
TROLLEY 7 DRAWERS WITH FOAM AND TOOLS	17
TROLLEY FOAMS 3/3 SYSTEM	18-20
TROLLEY FOAMS 1/3 SYSTEM	20-23
TOOL TROLLEYS	24-25
3 TOOL BOXES TOWER ON WHEELS	24
TOWER 3 IN 1 WITH FOAM AND TOOLS	24
2 TRAYS ROLL CART	25
1 MIDDLE TRAY FOR 9064K-02 ROLL CART	25
TRANSPORTERS	25
TRANSPORTER	25
FOLDABLE TRANSPORTER	25
METALLIC TOOL BOXES	26-29
TWO HANDLE MODEL	26
ONE HANDLE MODEL	26
GENERAL MAINTENANCE KIT	27
ALUMINIUM TOOL CASE WITH TOOLS	28
PLASTIC BOX - LOOSE KIT	29
PLASTIC TOOL BOX	29
FABRIC BAGS	30-31
TOOL BAG WITH TUBULAR HANDLE	30
TOOL BAG WITH ZIP	30
TOOL BAG WITH COMPOSITION	31
LAPTOP AND TOOL BACK-PACK	31
BACK-PACK WITH WHEELS	31
POUCHES, BELTS AND FOLDERS	32-34
FOLDER – EMPTY	32
FOLDER – WITH 18 TOOLS	32
FOLDER – WITH 28 TOOLS	32
HAMMER HOLDER	33
STRIKING SET	33
PLIER POUCH	33
ELECTRICIAN 4 PIECES SET IN POUCH	33
TOOL POUCH	34
MRO 7 PIECES SET IN POUCH	34
INSULATED 7 PIECES SET IN POUCH	34

10 POCKETS TOOL POUCH	34
MRO 9 PIECES SET IN POUCH	34
ADJUSTABLE BELT	34
02. WRENCHES	35-49
ADJUSTABLE WRENCHES	36-37
HEAVY DUTY ADJUSTABLE WRENCH	36
CENTRAL NUT	36
PHOSPHATED ADJUSTABLE WRENCH SET	36
STUBBY ADJUSTABLE WRENCH DISPLAY	37
OPEN END WRENCHES	37-38
DOUBLE OPEN END WRENCHES	37
DOUBLE OPEN END WRENCH SETS	38
COMBINATION WRENCHES	39-41
COMBINATION WRENCHES IN MM	39
COMBINATION WRENCHES IN INCHES	40
COMBINATION WRENCH SETS	40-41
RATCHETING COMBINATION WRENCHES	41-43
RATCHETING COMBINATION WRENCHES	41
RATCHETING COMBINATION WRENCH SETS	41-42
STUBBY RATCHETING COMBINATION WRENCHES	42
STUBBY RATCHETING COMBINATION WRENCH SET	42
RATCHETING DOUBLE RING WRENCH SET	42
FLEX HEAD RATCHETING COMBINATION WRENCHES	43
FLEX HEAD RATCHETING COMBINATION WRENCH SET	43
FLAT RING WRENCHES	44
DOUBLE RING END WRENCHES	44
DOUBLE RING END WRENCHES SETS	44
OFFSET RING WRENCHES	45
DOUBLE OFFSET RING WRENCHES	45
DOUBLE OFFSET RING WRENCH SETS	45
L-PIPE DOUBLE SOCKET WRENCHES	46
L-PIPE DOUBLE SOCKET WRENCHES	46
L-PIPE DOUBLE SOCKET WRENCH SETS	46
TUBULAR SOLID WRENCHES	47
DOUBLE HEAD SOCKET WRENCHES	47
DOUBLE HEAD SOCKET WRENCH SETS	47
BAR HANDLE FOR SOCKET WRENCH	47
SLOGGING RING, OPEN END	48
RING END SLOGGING WRENCH	48
OPEN END SLOGGING WRENCH	48

HOOK WRENCHES	49
HOOK WRENCH	49
HOOK WRENCH WITH INTERCHANGEABLE PIN	49
SPARE PART - INTERCHANGEABLE PIN	49
MULTIFITTING KEY	49
7 IN 1 UNIVERSAL KEY	49
9 IN 1 UNIVERSAL KEY	49

03. TORQUE TOOLS **51-53**

TORQUE WRENCHES	52-53
ADJUSTABLE CLICK WRENCH WITH FIXED RATCHET HEADS	52
ADJUSTABLE CLICK WRENCH WITH INTERCHANGEABLE HEADS	52
9x12 MM OPEN END INSERTS	52
9x12 MM RING END INSERTS	52
9x12 & 14x18 MM RATCHET HEAD INSERTS	53
14x18 MM OPEN END INSERTS	53
14x18 MM RING END INSERTS	53

04. SOCKETRY **55-83**

1/4" SOCKETS	56-60
1/4" HEXAGONAL SOCKETS	56
1/4" DEEP HEXAGONAL SOCKETS	56
1/4" TORX® SOCKETS	56
1/4" BIT DRIVERS	57
1/4" ACCESSORIES	58-59
1/4" SOCKET SETS	60
3/8" SOCKETS	61-63
3/8" HEXAGONAL SOCKETS	61
3/8" DEEP HEXAGONAL SOCKETS	61
3/8" ACCESSORIES	62-63
3/8" SOCKET SET	63
1/2" SOCKETS	64-74
1/2" HEXAGONAL SOCKETS	64
1/2" BIHEXAGONAL SOCKETS	64
1/2" BIHEXAGONAL DEEP SOCKETS	65
1/2" TORX® SOCKETS	65
1/2" BIT DRIVERS	66-67
1/2" ACCESSORIES	67-70
1/2" SOCKET SETS	70-74

3/4" SOCKETS	74-77
3/4" HEXAGONAL SOCKETS	74
3/4" BIHEXAGONAL SOCKETS	75
3/4" ACCESSORIES	75-76
3/4" SOCKET SETS	76-77
3/8" IMPACT SOCKETS	77-78
3/8" IMPACT HEXAGONAL SOCKETS, METRIC	77
3/8" IMPACT HEXAGONAL SOCKETS, LONG SERIES, METRIC	77
3/8" IMPACT ACCESSORIES	78
1/2" IMPACT SOCKETS	79-80
1/2" IMPACT HEXAGONAL SOCKETS, METRIC	79
1/2" IMPACT SOCKET RAIL SET	79-80
1/2" SOCKET SETS	79
1/2" IMPACT HEXAGONAL SOCKETS, LONG SERIES, METRIC	80
1/2" IMPACT ACCESSORIES	80
3/4" IMPACT SOCKETS	81-82
3/4" IMPACT HEXAGONAL SOCKETS, METRIC	81
3/4" IMPACT SOCKET SET	81
3/4" IMPACT HEXAGONAL SOCKETS, LONG SERIES, METRIC	81
3/4" IMPACT ACCESSORIES	81-82
1" IMPACT SOCKETS	82-83
1" IMPACT HEXAGONAL SOCKETS, METRIC	82
1" IMPACT SOCKET SET	82
1" IMPACT HEXAGONAL SOCKETS, LONG SERIES, METRIC	83
1" IMPACT ACCESSORIES	83

05. CLAMPING TOOLS **85-91**

BENCH VICES	86-87
ROUND GUIDE VICE	86
SQUARE GUIDE VICE	86-87
SPARE PARTS FOR BENCH VICES	87-88
ACCESSORIES FOR BENCH VICES	88-89
TABLE VICE	89
SCREW CLAMPS	90-91
FORGED WOODEN HANDLE F-CLAMP	90
STEEL CLAMP, 90 MM	90
STEEL T-HANDLE CLAMP, 120 MM	90
NON-SLIP BRAKING MECHANISM CLAMP, 150 MM	90
LIGHT SCREW CLAMP, 70 MM	90
FORGED RATCHETING F-CLAMP	91
QUICK CLAMPS	91

06. PIPE TOOLS 93-97

STILLSON WRENCHES	94
STILLSON WRENCH	94
ALUMINIUM WRENCH	94
CHAIN PIPE WRENCH	95
CHAIN PIPE WRENCH	95
SPARE CHAIN	95
PIPE WRENCHES SWEDISH MODEL	95
CORNER MOUTH	95
PERPENDICULAR MOUTH	95
CURVED MOUTH	95
PIPE CUTTERS	96
SMALL COPPER PIPE CUTTER	96
MULTIPURPOSE PIPE CUTTER	96
TELESCOPIC COPPER PIPE CUTTER	96
STEEL PIPE CUTTER	96
SPARE WHEELS	96
AUTO RETRACT PLASTIC TUBE CUTTER	96
SPARE BLADE	96
GASKET CUTTERS	97
GASKET CUTTERS SETS	97
GASKET CUTTERS	97
WAD PUNCHES 3 - 30 HANDLE	97
REVOLVER WAD PUNCHES	97

07. SCREWDRIVERS & BITS 99-132

SCREWDRIVERS	100-102
SLOTTED SCREWDRIVERS FOR ENGINEERINGS	100
SLOTTED SCREWDRIVERS FOR ELECTRICIANS	100
STUBBY SLOTTED SCREWDRIVERS	100
PHILLIPS SCREWDRIVERS	101
STUBBY PHILLIPS SCREWDRIVERS	101
POZIDRIV SCREWDRIVERS	101
STUBBY POZIDRIV SCREWDRIVERS	101
TORX® SCREWDRIVERS	102
NUT DRIVER WITH HANDLE 1/4"	102
MAGNETIC BIT HOLDER FOR 1/4" BITS	102
FLEXIBLE BLADE BIT HOLDER FOR 1/4" BITS	102
NUT DRIVER WITH HANDLE, WITH FLEXIBLE BLADE 1/4"	103

RATCHETING BIT HOLDER FOR 1/4" BITS	103
RATCHETING BIT HOLDER SCREWDRIVER FOR 1/4" BITS	103
RATCHETING BIT HOLDER STUBBY FOR 1/4" BITS	103
INSULATED 1000V SCREWDRIVERS	104-105
SLOTTED INSULATED 1000V SCREWDRIVERS	104
PHILLIPS INSULATED 1000V SCREWDRIVERS	104
POZIDRIV INSULATED 1000V SCREWDRIVERS	104
TORX® INSULATED 1000V SCREWDRIVERS	104
TWIN PACK INSULATED SCREWDRIVERS + TESTER	105
SCREWDRIVER SETS	105-106
SCREWDRIVER DISPLAYS	107
INSULATED SCREWDRIVER SETS	108
INSULATED SCREWDRIVER DISPLAY	108
T-HANDLE SCREWDRIVERS	108-109
T-HANDLE WITH HEXAGONAL TIP	108
T-HANDLE WITH TORX® TIP	109
T-HANDLE WITH HEXAGONAL BALL TIP	109
T-HANDLE SCREWDRIVERS, NUT DRIVER	109
HEX BALL END T HANDLE SET	109
6 IN 1 SCREWDRIVER	110
REVERSIBLE SCREWDRIVER	110
MAGNETISER	110
PRECISION SCREWDRIVER	111
PRECISION SCREWDRIVER SET	111
POCKET PRECISION SCREWDRIVER	111
VOLTAGE TESTER	111
NICKEL PLATED KEYS FOR HEX SCREWS	112-113
NICKEL PLATED KEYS, METRIC	112
NICKEL PLATED KEYS, INCHES	112
NICKEL PLATED KEYS SETS	112-113
OFFSET SCREWDRIVER SET	113
CHROME PLATED KEYS FOR HEX SCREWS, LONG	113
BLACK KEYS FOR HEX SCREWS	113-115
BLACK KEYS, METRIC	113-114
BLACK KEYS SETS	114
BLACK KEYS, INCHES	115
BLACK KEYS SETS	115
BLACK KEYS FOR HEX SCREWS, LONG	115-116
BLACK KEYS, METRIC LONG	115
LONG BALL END, METRIC	116
BLACK KEYS SETS	116

BLACK KEYS FOR TORX® SCREWS	117	10 MM BITS FOR TORX® TAMPER SCREWS	131
BLACK KEYS FOR TORX® SCREWS	117	10 MM BITS FOR XZN SCREWS	131
BLACK KEY SETS FOR TORX® SCREWS	117	10 MM SQUARE BITS	131
BLACK KEYS FOR TORX® TAMPER RESISTANT SCREWS	118	1/2" SOCKET DRIVERS	132
BLACK KEYS FOR TORX® TAMPER RESISTANT SCREWS	118	1/2" SOCKET DRIVERS FOR TORX® TAMPER SCREWS	132
BLACK KEY SETS FOR TORX® TAMPER RESISTANT SCREWS	118	10 MM BITS SETS	132
1/4" BITS	119-125	08. STRIKING TOOLS	133-144
1/4" BITS FOR SLOTTED SCREWS	119	PUNCHES AND CHISELS	134-138
1/4" BITS FOR PHILLIPS SCREWS	119-120	COLD CHISELS	134
1/4" BITS FOR PHILLIPS DRY WALL SCREWS	120	FLAT COLD CHISELS	134
1/4" BITS FOR POZIDRIV SCREWS	120-121	EXTRAFLAT COLD CHISEL	134
1/4" BITS FOR TORX® SCREWS	121-122	CAPE CHISELS	134
1/4" BITS FOR TORX® TAMPER SCREWS	122	FLAT CAPE CHISELS	134
1/4" BITS FOR HEXAGONAL SCREWS	122	ROUND CENTRE PUNCHES	135
TORSION BIT FOR PHILLIPS HEAD SCREWS	123	ROUND CENTRE PUNCH SETS	135
TORSION BIT FOR POZIDRIV HEAD SCREWS	123	OCTAGONAL CENTRE PUNCHES	135
DIAMOND BIT FOR PHILLIPS HEAD SCREWS	123	ROUND TAPER PUNCHES	135
DIAMOND BIT FOR POZIDRIV HEAD SCREWS	123	OCTAGONAL TAPER PUNCHES	135
1/4" POWER MAGNETIC NUT DRIVER	124	ROUND TAPER PUNCH SET	136
1/4" POWER MAGNETIC NUT DRIVER SET	124	OCTAGONAL TAPER PUNCH SETS	136
1/4" POWER MAGNETIC NUT DRIVER WITH RETAINING RING	124	ROUND PARALLEL PIN PUNCHES	136
ADAPTOR 1/4"	125	OCTAGONAL PARALLEL PIN PUNCHES	136
UNIVERSAL HOLDER 1/4"	125	ROUND PARALLEL PIN PUNCH SET	137
QUICK RELEASE BIT HOLDER 1/4"	125	OCTAGONAL PARALLEL PIN PUNCH SETS	137
1/4" BITS SETS	126-127	ROUND PARALLEL PIN PUNCHES, LONG SERIES	137
PRECISION SCREWDRIVER SET FOR PRECISION ENGINEERING AND ELECTRONICS APPLICATIONS	127	OCTAGONAL PARALLEL PIN PUNCHES, LONG SERIES	137
5/16" BITS	128	ROUND PARALLEL PIN PUNCH SETS, LONG SERIES	137
5/16" BITS FOR SLOTTED SCREWS	128	ELECTRICIAN'S COLD CHISELS	138
5/16" BITS FOR PHILLIPS SCREWS	128	SET	138
5/16" BITS FOR HEXAGONAL SCREWS	128	ENGINEERS SCRIBERS	138
5/16" BITS FOR TORX® SCREWS	128	WRECKING BARS	138
5/16" IMPACT SCREWDRIVER	129	HAMMERS	139-143
5/16" IMPACT SCREWDRIVER	129	CURVED CLAW HAMMERS	139
5/16" IMPACT SCREWDRIVER ADAPTOR	129	STUBBY CLAW HAMMERS	139
5/16" IMPACT DRIVER BIT SET	129	SPANISH TYPE CURVED CLAW HAMMERS	139
10 MM BITS	130-131	JOINER'S HAMMERS	140
10 MM BITS FOR HEXAGONAL SCREWS	130	GERMAN DIN HAMMERS	140
10 MM BITS FOR TORX® SCREWS	130	RIVOIR HAMMERS	141
1/2" ADAPTOR FOR 10 MM BITS	130	BALL PEIN HAMMERS	141
3/8" ADAPTOR FOR 10 MM BITS	130		

SPANISH STONING HAMMERS	142	BOLT CUTTERS	153
STONING HAMMERS	142	BOLT CUTTERS	153
BLACK RUBBER MALLET	142	SPARE HEAD	153
ANTI-BOUNCE NYLON FACED HAMMER	143	PINCERS AND FENCING PLIERS	153
NYLON FACED HAMMERS	143	CARPENTER'S PINCERS	153
SPARE POLLS	143	FENCING PLIERS	153
CHISELS	144	FENCING PLIERS WITH PVC DIPPED HANDLES	153
CHISEL SETS	144	CIRCLIP PLIERS	154
WOOD CARVING SET	144	INTERNAL STRAIGHT	154
		INTERNAL BENT	154
		EXTERNAL STRAIGHT	154
		EXTERNAL BENT	154
		CIRCLIP SET	154
		METAL SHEARS	155
		STRAIGHT CUT	155
		RIGHT CUT	155
		LEFT CUT	155
		LOCKING PLIERS	155-157
		UNIVERSAL, CURVED JAWS WITH WIRE CUTTER	155
		UNIVERSAL, STRAIGHT JAWS	155
		LONG NOSE	156-157
		WELDING	156
		STEEL CLAMP	156
		STEEL CLAMP, SWIVEL PADS	156
		STEEL CLAMP, SWIVEL PADS, SLIM	156
		TABLE C CLAMP	156
		4 POSITION PLIERS	157
		CURVED JAWS WITH CUTTER	157
		SOFT GRIP PLIERS SET	157
		AUTOMATIC HAND VICES	157
		RIVETING TOOLS	158
		HAND RIVETER	158
		2 ARM RIVETER	158
		NUT RIVETER	158
		HAND RIVETER SET WITH RIVETS	158
		UTILITY KNIFE	159
		9 MM SNAP OFF KNIFE	159
		18 MM SNAP OFF KNIFE	159
		SAFETY UTILITY KNIFE	159
		QUICK CHANGE CUTTER	159
		GLASS SCRAPER WITH INTERCHANGEABLE BLADES	159
		MULTIPURPOSE TRADESMAN KNIVES WITH SHEATH	159
09. PLIERS – SCISSORS AND KNIVES	145-161		
PLIERS	146-147		
SIDE CUTTING PLIERS	146		
COMBINATION PLIERS	146		
SNIPE NOSE PLIERS	146		
SNIPE NOSE PLIERS BENT TIP	146		
FLAT NOSE PLIERS	146		
ROUND NOSE PLIERS	147		
SLIP JOINT PLIERS	147		
QUICK ADJUST SLIP JOINT PLIERS	147		
PLIERS SETS	147		
MINI PLIERS	148-149		
PLIERS FOR ELECTRICIANS	149-150		
STRIPPING PLIERS	149		
COPPER ALUMINIUM WIRE CUTTER	149		
CRIMPING PLIER INSULATED TERMINALS	150		
CRIMPING PLIER NON-INSULATED TERMINALS	150		
CRIMPING PLIER NON-INSULATED FASTON TYPE TERMINALS	150		
CRIMPING PLIER INSULATED TERMINALS SET	150		
INSULATED PLIERS	151-152		
INSULATED COMBINATION PLIERS	151		
INSULATED FLAT NOSE PLIER	151		
INSULATED SNIPE NOSE PLIERS	151		
INSULATED SNIPE NOSE PLIERS BENT TIP	151		
INSULATED SIDE CUTTING PLIERS	152		
INSULATED HEAVY DUTY SIDE CUTTING PLIERS	152		
INSULATED STRIPPING PLIERS	152		
INSULATED SLIP JOINT PLIERS	152		
INSULATED PLIERS SETS	152		

ELECTRICIAN'S SCISSORS AND KNIVES	160-161
FOLDABLE KNIFE	160
ELECTRICIANS' KNIFE	160
MULTITOOL	160
ELECTRICIANS' SCISSORS	161
HOOKS AND PICKING TOOLS	161
MINI PICK AND HOOK SET	161

10. PULLING TOOLS **163-168**

PULLERS	164-165
UNIVERSAL 2 ARM PULLERS	164
SELF-CENTERING 2 ARMS PULLERS	164
SELF-CENTERING 3 ARMS PULLERS	165
MULTIPLE PULLERS	165
EXTRACTORS	166
STUD EXTRACTORS BIT SET	166
STUD EXTRACTORS SETS	166
TAP WRENCH	166
NUT SPLITTER	166
PICK-UP TOOLS	167
MAGNETIC PICK-UP TOOL	167
CLAW PICK-UP TOOL	167
PRY BARS	167-168
PRY BAR	167
OFFSET LEVER SET	168
OFFSET LEVER	168
SHEET PUNCHES	168
SHEET METAL PUNCHES	168
SPARE BOLT	168

11. CUTTING TOOLS AND MEASURING **169-180**

BOWSAW FRAMES AND BLADES	170
BOWSAW FRAMES	170
BOWSAW BLADES, GREEN WOOD	170
BOWSAW BLADES, DRY WOOD	170
HACKSAW FRAMES AND BLADES	170-172
HANDBSAWS	170
TENON SAW	170
GENERAL PURPOSE HANDSAW	171
DOVETAIL FLEX HANDSAW	171
COMPASS SAW	171

ALUMINIUM HACKSAW FRAME	171
HACKSAW FRAME	171
BI-METAL	171
ALUMINIUM HOLDER	172
HACKSAW FRAME	172

HOLESAWS **172**

FILES **172-173**

FLAT FILES	172
HAND FILES	172
HALF ROUND FILES	173
ROUND FILES	173
THREE SQUARE FILES	173
SQUARE FILES	173
FILE SET	173

SPIRIT LEVELS **174-175**

SPIRIT LEVELS	174
MAGNETIC SPIRIT LEVELS	174
SET OF LEVELS	174
TORPEDO LEVEL	175
POCKET SPIRIT LEVEL	175
ALUMINUM LEVEL WITH HOLSTER	175

MEASURING TAPES **175-177**

MEASURING TAPES	175
TAPE TWINPACK	176
HIGH VISIBILITY MEASURING TAPES	176
MEASURING TAPE WITH TRANSPARENT CASE	176
MEASURING TAPE FOR VERTICAL MEASUREMENTS	176
LONGS TAPES	177

WOODEN FOLDING RULE **177**

SQUARES **177**

SQUARES	177
COMBINATION SQUARES	177

GAUGE SETS **178**

SCREW PITCH GAUGE SET	178
FEELER GAUGE SETS	178

CALIPERS **178**

VERNIER CALIPER 150 MM	178
DIGITAL VERNIER CALIPER 150 MM	178

INFRARED THERMOMETER **178**

FASTENING TOOLS **179**

CAULKING GUNS	179
ELECTRONIC GLUE GUN SET	179

PAINT SCRAPERS	179	POINT OF SALE MATERIAL	188-190
PAINT SCRAPERS	179	METAL WALL 1 SIDE 2 LEGS	189
BODY WORK SCRAPER SET	179	LIGHTBOX	189
STAPLERS	180	SIGN CARRIER + SIGN IRIMO	189
HEAVY DUTY STAPLE GUN 4 IN 1	180	METAL WALL CORNER 1 LEG	189
HEAVY DUTY STAPLES	180	LIGHTBOX CORNER WALL	189
BRAD NAILS 15 MM	180	DOUBLE SIDE WALL WITH WHEELS	190
HAMMER TACKER	180	TRIANGULAR METAL WALL WITH WHEELS	190
LIGHT DUTY STAPLES	180	SPARE PARTS FOR METAL WALL	190
CABLE STAPLES	180	METHACRYLATE FOR LIGHTBOX	190
		PVC TOP SIGN FOR SIGN CARRIER	190
		TOP SIGN FOR DOUBLE SIDED WALL	190
		BANNER FOR METAL WALLS	190
12. LIGHTING AND POWER TOOLS	181-187	ADDITIONAL POS MATERIAL. EMPTY DISPLAYS	190-191
POCKET LAMPS	182-183	STICKERS A4 SHEET	190
FLEXIBLE LIGHT	182	GENERIC COUNTER DISPLAY	191
COMPACT LIGHT	182	COUNTER S DISPLAY	191
SLIM FLEX	182	COUNTER L DISPLAY	191
MINI FLEXIBLE LIGHT	183	PALLET COVER EUROPALLET	191
POCKET FLEX LIGHT	183	COUNTER DISPLAY FOR PLIERS	191
INSPECTION LAMPS	183	STAND ALONE	191
ALUMINIUM TORCH	183		
PEN LIGHT	183		
WORKING LAMPS	184		
BOOK LIGHT	184		
HEAD LAMPS	184		
HEAD LIGHT	184		
PNEUMATIC TOOLS	185-186		
3/8" IMPACT WRENCH	185		
3/4" IMPACT WRENCH	185		
1/2" IMPACT WRENCH	185		
1" IMPACT WRENCH	185		
1/4" RATCHET	186		
1/2" RATCHET	186		
BLOW GUN	186		
AIR LINE COUPLERS	186		
1/4" QUICK CONNECTOR	186		
IN LINE LUBRICATOR	186		
FILTER REGULATORS	187		
FILTER REGULATOR	187		
FILTER REGULATOR LUBRICATOR	187		
CORDLESS SCREWDRIVER	187		
3.6V CORDLESS SCREWDRIVER	187		



01. TOOL STORAGE



TOOL TROLLEYS

5 DRAWER TOOL TROLLEY

[YouTube](#)

6 DRAWER TOOL TROLLEY

[YouTube](#)

7 DRAWER TOOL TROLLEY

[YouTube](#)

- 5 drawer trolley
 - Drawers with internal dimensions of:
 - (1 x) 543 x 445 x 50 mm
 - (2 x) 543 x 445 x 116 mm
 - (2 x) 543 x 445 x 182 mm
 - Large capacity heavy duty construction trolley
 - Double wall frame protects the sides and drawers from shocks/crashes
 - Reinforced areas to reduce stress in specific points of the trolley
 - Long ball bearing slides with 100% opening drawers
 - Click/detent closing system of drawers
 - Strong and secure central locking mechanism
 - Wheels of 125 x 30 mm with ball bearings and non-marking rubber outer surface:
 - 2 fixed and 2 swivel with brake
- 6 drawer trolley
 - Drawers with internal dimensions of:
 - (3 x) 543 x 445 x 50 mm
 - (2 x) 543 x 445 x 116 mm
 - (1 x) 543 x 445 x 246 mm
- 7 drawer trolley
 - Drawers with internal dimensions of:
 - (5 x) 543 x 445 x 50 mm
 - (1 x) 543 x 445 x 116 mm
 - (1 x) 543 x 445 x 246 mm

Part No.	Qty	Dimensions (mm)	Weight (kg)	Height (mm)	Width (mm)	Depth (mm)	Wheels (mm)	Capacity (kg)
9066K5	1	677 x 501 x 954	400	543 x 445 x h	25	125 x 30	48	
9066K6	1	677 x 501 x 954	400	543 x 445 x h	25	125 x 30	51	
9066K7	1	677 x 501 x 954	400	543 x 445 x h	25	125 x 30	52	

4 DRAWER TOP CHEST



SPARE PARTS

9066K-01	SP Slides (2x)	30 kg capacity
9066K-02	SP Swivel wheels (2x)	125 x 30 mm
9066K-03	SP Fixed wheels (2x)	125 x 30 mm
9066K-05	SP Handle x 9066K series	
9066K-06	SP Top mat x 26 trolleys	
9064-15	SP Pocket handles (2x)	
9064AC01	SP Drawer liner-7 units set	

- 4 drawers top chest
- Large capacity heavy duty construction top chest
- Double wall frame protects the slides and drawers from shocks/crashes
- Reinforced areas to reduce stress in specific points of the trolley
- Long ball bearing slides with 100% opening drawers
- Click/detent closing system of drawers
- Strong and secure central locking mechanism
- Drawers with internal dimensions of:
 - (3 x) 543 x 445 x 50 mm
 - (1 x) 543 x 445 x 116 mm

Part No.	Qty	Dimensions (mm)	Weight (kg)	Height (mm)	Width (mm)	Depth (mm)	Capacity (kg)
9065K4	1	677 x 501 x 420	250	543 x 445 x h	25	38	

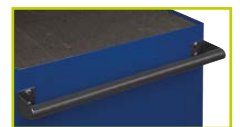
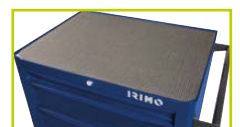



TROLLEY 6 DRAWERS WITH FOAM AND TOOLS, 206 pieces



YouTube



IFF1A001



IFF1A002



IFF1A003

9066K6FF100	1	677 x 501 x 954
		80

IFF1A001

045001, 045011, 045021	
101-04-1, 101-045-1, 101-05-1, 101-055-1, 101-06-1, 101-07-1, 101-08-1, 101-09-1, 101-10-1, 101-11-1, 101-12-1, 101-13-1, 101-14-1	
103-04-1, 103-05-1, 103-06-1, 103-07-1, 103-08-1, 103-09-1, 103-10-1, 103-11-1, 103-12-1, 103-13-1	
105-22-1, 105-24-1	
105-40-1	
105-42-1	
105-48-1	
105-50-1	
105-70-1	
106-04-1, 106-05-1, 106-06-1, 106-07-1, 106-08-1	
121-10-1, 121-11-1, 121-12-1, 121-13-1, 121-14-1, 121-15-1, 121-16-1, 121-17-1, 121-18-1, 121-19-1, 121-20-1, 121-21-1, 121-22-1, 121-24-1, 121-27-1, 121-30-1, 121-32-1	
125-23-1, 125-25-1	
125-40-1	
125-42-1	
125-48-1	
125-53-1, 125-54-1	
124-14-1, 124-15-1, 124-17-1, 124-19-1, 124-22-1	
125-70-1	
126-10-1, 126-11-1, 126-12-1, 126-14-1, 126-16-1, 126-18-1, 126-20-1, 126-24-1	
475-4-1, 475-5.5-1, 475-6.5-1	
475-H3-1, 475-H4-1, 475-H5-1, 475-H6-1	
475-PH1-1, 475-PH2-1	
475-PZ1-1, 475-PZ2-1	
475-T8-1, 475-T10-1, 475-T15-1, 475-T20-1, 475-T25-1, 475-T27-1, 475-T30-1	

IFF1A002

529171	
475-61-1	
48-9-H	
511-105-1	
515-002-1, 515-003-1, 515-004-1, 515-005-1, 515-006-1	
5-250C-1	
527-61-2	
601-180-1	
612-160-1	
625-180-1	
634-250-1	
666-156-1	
980-38-1	

IFF1A003

25-06-2, 25-07-2, 25-08-2, 25-09-2, 25-10-2, 25-11-2, 25-12-2, 25-13-2, 25-14-2, 25-15-2, 25-16-2, 25-17-2, 25-18-2, 25-19-2, 25-21-2, 25-22-2, 25-24-2, 25-27-2, 25-30-2, 25-32-2	
407-4-100, 407-5.5-125, 407-6.5-150, 407-8-175	
409-1-100, 409-2-125, 409-3-150	
9066K6	

TOOL TROLLEYS

TROLLEY 6 DRAWERS WITH FOAM AND TOOLS, 178 pieces



YouTube



IFF1A004



IFF1A005



IFF1A006

9066K6FF101	1	677 x 501 x 950	80

IFF1A004

101-04-1, 101-045-1, 101-05-1, 101-055-1, 101-06-1, 101-07-1, 101-08-1, 101-09-1, 101-10-1, 101-11-1, 101-12-1, 101-13-1		1/4"
103-04-1, 103-05-1, 103-06-1, 103-07-1, 103-08-1, 103-09-1, 103-10-1, 103-11-1, 103-12-1, 103-13-1		1/4"
105-22-1, 105-24-1		
105-40-1		
105-42-1		
105-48-1		
105-50-1		
105-70-1		
121-10-1, 121-11-1, 121-12-1, 121-13-1, 121-14-1, 121-15-1, 121-17-1, 121-19-1, 121-22-1, 121-24-1, 121-27-1, 121-30-1, 121-32-1		1/2"
125-23-1, 125-25-1		
125-40-1		
125-42-1		
125-48-1		
125-54-1		
125-70-1		
407-4-100, 407-5.5-125, 407-6.5-150, 407-8-175		
408-6.5-25		
409-1-100, 409-2-125, 409-3-150		
409-2-25		
413-1-100, 413-2-125		

IFF1A005

529171	
527-61-2	
475-61-1	
48-9-H	
501-250-1	
511-105-1	
515-002-1, 515-003-1, 515-004-1, 515-005-1, 515-006-1	
5-150C-1, 5-250C-1	
601-180-1	
612-160-1	
625-180-1	
634-250-1	
665-200-1	
980-3B-1	

IFF1A006

25-06-2, 25-07-2, 25-08-2, 25-09-2, 25-10-2, 25-11-2, 25-12-2, 25-13-2, 25-14-2, 25-15-2, 25-16-2, 25-17-2, 25-18-2, 25-19-2, 25-21-2, 25-22-2, 25-24-2, 25-27-2, 25-30-2, 25-32-2	
10-0607-1, 10-0809-1, 10-1011-1, 10-1213-1, 10-1415-1, 10-1617-1, 10-1819-1, 10-2022-1, 10-2123-1, 10-2427-1, 10-3032-1	
9066K6	

TROLLEY 7 DRAWERS WITH FOAM AND TOOLS, 222 pieces



YouTube



IFF1A004



IFF1A005



IFF1A006



IFF1A007

9066K7FF102
1
677 x 501 x 954
90

IFF1A004

101-04-1, 101-045-1, 101-05-1, 101-055-1, 101-06-1, 101-07-1, 101-08-1, 101-09-1, 101-10-1, 101-11-1, 101-12-1, 101-13-1	
103-04-1, 103-05-1, 103-06-1, 103-07-1, 103-08-1, 103-09-1, 103-10-1, 103-11-1, 103-12-1, 103-13-1	
105-22-1, 105-24-1	
105-40-1	
105-42-1	
105-48-1	
105-50-1	
105-70-1	
121-10-1, 121-11-1, 121-12-1, 121-13-1, 121-14-1, 121-15-1, 121-17-1, 121-19-1, 121-22-1, 121-24-1, 121-27-1, 121-30-1, 121-32-1	
125-23-1, 125-25-1	
125-40-1	
125-42-1	
125-48-1	
125-54-1	
125-70-1	
407-4-100, 407-5.5-125, 407-6.5-150, 407-8-175	
408-6.5-25	
409-1-100, 409-2-125, 409-3-150	
409-2-25	
413-1-100, 413-2-125	

IFF1A005

529171	
527-61-2	
475-61-1	
48-9-H	
501-250-1	
511-105-1	
515-002-1, 515-003-1, 515-004-1, 515-005-1, 515-006-1	
5-150C-1, 5-250C-1	
601-180-1	
612-160-1	
625-180-1	
634-250-1	
665-200-1	
980-3B-1	

IFF1A006

25-06-2, 25-07-2, 25-08-2, 25-09-2, 25-10-2, 25-11-2, 25-12-2, 25-13-2, 25-14-2, 25-15-2, 25-16-2, 25-17-2, 25-18-2, 25-19-2, 25-21-2, 25-22-2, 25-24-2, 25-27-2, 25-30-2, 25-32-2	
10-0607-1, 10-0809-1, 10-1011-1, 10-1213-1, 10-1415-1, 10-1617-1, 10-1819-1, 10-2022-1, 10-2123-1, 10-2427-1, 10-3032-1	
IFF1A007	
534261	
534291	
534321	
534351	
534381	
534411	
180-05-1, 180-06-1, 180-07-1, 180-08-1, 180-10-1, 180-12-1, 180-14-1, 180-17-1	
180-05X-1, 180-06X-1, 180-07X-1, 180-08X-1, 180-10X-1, 180-12X-1	
183-30-1, 183-40-1, 183-45-1, 183-50-1, 183-55-1, 183-60-1	
183-40X-1, 183-45X-1, 183-50X-1, 183-55X-1	
458-8-F	
716-M6-1, 716-M8-1, 716-M11-1, 716-M14-1, 716-M18-1,	
801-145-1	
9066K7	

1

2

3

4

5

6

7

8

9

10

11

12

TROLLEY FOAMS 3/3 SYSTEM

IFF1A001



- 3/3 Foam Inlay Socket sets / ratchet / bits
- 94 pieces



IFF1A001 1 445 x 543 x 40

045001, 045011, 045021

101-04-1, 101-045-1, 101-05-1, 101-055-1, 101-06-1, 101-07-1, 101-08-1, 101-09-1, 101-10-1, 101-11-1, 101-12-1, 101-13-1, 101-14-1

103-04-1, 103-05-1, 103-06-1, 103-07-1, 103-08-1, 103-09-1, 103-10-1, 103-11-1, 103-12-1, 103-13-1

105-22-1, 105-24-1

105-40-1

105-42-1

105-48-1

105-50-1

105-70-1

106-04-1, 106-05-1, 106-06-1, 106-07-1, 106-08-1

121-10-1, 121-11-1, 121-12-1, 121-13-1, 121-14-1, 121-15-1, 121-16-1, 121-17-1, 121-18-1, 121-19-1, 121-20-1, 121-21-1, 121-22-1, 121-24-1, 121-27-1, 121-30-1, 121-32-1

125-23-1, 125-25-1

125-40-1

125-42-1

125-48-1

125-53-1, 125-54-1

124-14-1, 124-15-1, 124-17-1, 124-19-1, 124-22-1

125-70-1

126-10-1, 126-11-1, 126-12-1, 126-14-1, 126-16-1, 126-18-1, 126-20-1, 126-24-1

475-4-1, 475-5.5-1, 475-6.5-1

475-H3-1, 475-H4-1, 475-H5-1, 475-H6-1

475-PH1-1, 475-PH2-1

475-PZ1-1, 475-PZ2-1

475-T8-1, 475-T10-1, 475-T15-1, 475-T20-1, 475-T25-1, 475-T27-1, 475-T30-1

IFF1A002



- 3/3 Foam Inlay Striking tools / Cutting tools / Measuring tape / Pliers
- 85 pieces



IFF1A002 1 445 x 543 x 40

529171

475-61-1

48-9-H

511-105-1

515-002-1, 515-003-1, 515-004-1, 515-005-1, 515-006-1

5-250C-1

527-61-2

601-180-1

612-160-1

625-180-1

634-250-1

666-156-1

980-3B-1

IFF1A003



- 3/3 Foam Inlay Combination wrenches / Screwdrivers
- 27 pieces



IFF1A003 1 445 x 543 x 40

25-06-2, 25-07-2, 25-08-2, 25-09-2, 25-10-2, 25-11-2, 25-12-2, 25-13-2, 25-14-2, 25-15-2, 25-16-2, 25-17-2, 25-18-2, 25-19-2, 25-21-2, 25-22-2, 25-24-2, 25-27-2, 25-30-2, 25-32-2

407-4-100, 407-5.5-125, 407-6.5-150, 407-8-175

409-1-100, 409-2-125, 409-3-150



IFF1A004



- 3/3 Foam Inlay Socket set / Screwdrivers / Ratchets
- 60 pieces

IFF1A004	1	445 x 543 x 40

101-04-1, 101-045-1, 101-05-1, 101-055-1, 101-06-1, 101-07-1, 101-08-1, 101-09-1, 101-10-1, 101-11-1, 101-12-1, 101-13-1		1/2
103-04-1, 103-05-1, 103-06-1, 103-07-1, 103-08-1, 103-09-1, 103-10-1, 103-11-1, 103-12-1, 103-13-1		1/2
105-22-1, 105-24-1		
105-40-1		
105-42-1		
105-48-1		
105-50-1		
105-70-1		
121-10-1, 121-11-1, 121-12-1, 121-13-1, 121-14-1, 121-15-1, 121-17-1, 121-19-1, 121-22-1, 121-24-1, 121-27-1, 121-30-1, 121-32-1		1/2
125-23-1, 125-25-1		
125-40-1		
125-42-1		
125-48-1		
125-54-1		
125-70-1		
407-4-100, 407-5-5-125, 407-6-5-150, 407-8-175		
408-6-5-25		
409-1-100, 409-2-125, 409-3-150		
409-2-25		
413-1-100, 413-2-125		

IFF1A005



- 3/3 Foam Inlay Striking tools / Cutting tools / Pliers
- 87 pieces

IFF1A005	1	445 x 543 x 40

529171		
527-61-2		
475-61-1		
48-9-H		
501-250-1		
511-105-1		
515-002-1, 515-003-1, 515-004-1, 515-005-1, 515-006-1		
5-150C-1, 5-250C-1		
601-180-1		
612-160-1		
625-180-1		
634-250-1		
665-200-1		
980-3B-1		

IFF1A006



- 3/3 Foam Inlay Combination wrenches / Open end wrenches
- 31 pieces

IFF1A006	1	445 x 543 x 40

25-06-2, 25-07-2, 25-08-2, 25-09-2, 25-10-2, 25-11-2, 25-12-2, 25-13-2, 25-14-2, 25-15-2, 25-16-2, 25-17-2, 25-18-2, 25-19-2, 25-21-2, 25-22-2, 25-24-2, 25-27-2, 25-30-2, 25-32-2	
10-0607-1, 10-0809-1, 10-1011-1, 10-1213-1, 10-1415-1, 10-1617-1, 10-1819-1, 10-2022-1, 10-2123-1, 10-2427-1, 10-3032-1	

TROLLEY FOAMS 3/3 & 1/3 SYSTEM

IFF1A007



- 3/3 Foam Inlay Socket set / Files / Cutting tools
- 44 pieces



IFF1A007 1 445 x 543 x 40

534261		
534291		
534321		
534351		
534381		
534411		
180-05-1, 180-06-1, 180-07-1, 180-08-1, 180-10-1, 180-12-1, 180-14-1, 180-17-1		
180-05X-1, 180-06X-1, 180-07X-1, 180-08X-1, 180-10X-1, 180-12X-1		
183-30-1, 183-40-1, 183-45-1, 183-50-1, 183-55-1, 183-60-1		
183-40X-1, 183-45X-1, 183-50X-1, 183-55X-1		
458-8-F		
716-M6-1, 716-M8-1, 716-M11-1, 716-M14-1, 716-M18-1,		
801-145-1		

IFF1E001

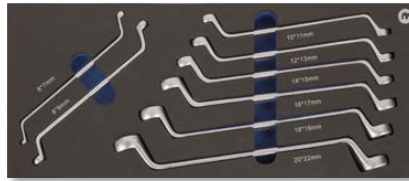

- Double offset ring wrenches
- 8 pieces



IFF1E001 1 445 x 181 x 40

15-0607-1, 15-0809-1, 15-1011-1,
15-1213-1, 15-1415-1, 15-1617-1,
15-1819-1, 15-2022-1



IFF1E002

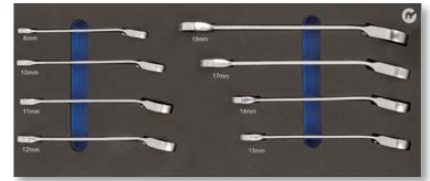

- Ratcheting combination wrenches
- 8 pieces



IFF1E002 1 445 x 181 x 40

18-08-1, 18-10-1, 18-11-1, 18-12-1,
18-13-1, 18-14-1, 18-17-1, 18-19-1

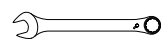

IFF1E003



- Double open end wrenches
- 10 pieces



IFF1E003 1 445 x 181 x 40

10-0607-1, 10-0809-1, 10-1011-1,
10-1213-1, 10-1415-1, 10-1617-1,
10-1819-1, 10-2022-1, 10-2427-1,
10-3032-1

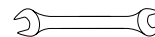

IFF1E004



- Combination wrenches
- 16 pieces



IFF1E004 1 445 x 181 x 40

25-06-2, 25-07-2, 25-08-2, 25-09-2,
25-10-2, 25-11-2, 25-12-2, 25-13-2,
25-14-2, 25-15-2, 25-16-2, 25-17-2,
25-18-2, 25-19-2, 25-21-2, 25-22-2

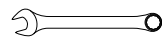

IFF1E005



- Open pipe socket wrench, Hex
- 11 pieces



IFF1E005 1 445 x 181 x 40

52-08-1, 52-10-1, 52-11-1, 52-12-1,
52-13-1, 52-14-1, 52-15-1, 52-16-1,
52-17-1, 52-18-1, 52-19-1

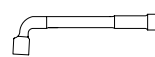

IFF1E006

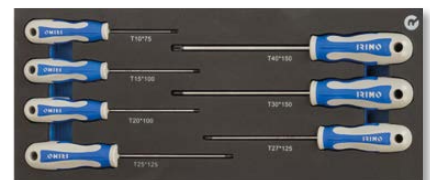

- TORX® screwdrivers
- 7 pieces



IFF1E006 1 445 x 181 x 40

414-10-75, 414-15-100,
414-20-100, 414-25-125,
414-27-125, 414-30-150,
414-40-150





IFF1E007



- Electrician straight and stubby screwdrivers, enginner slotted screwdriver
- 7 pieces

IFF1E007	1	445 x 181 x 40

408-3-75, 408-3.5-100, 408-4-100, 408-5.5-125, 408-6.5-150	
407-8-150	
408-5.5-25	

IFF1E008

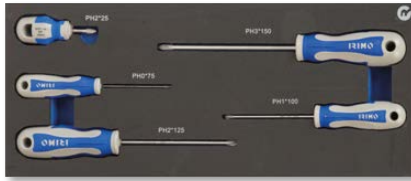

- Phillips screwdrivers
- 5 pieces

IFF1E008	1	445 x 181 x 40

409-0-75, 409-1-100, 409-2-125, 409-3-150	
409-2-25	

IFF1E009

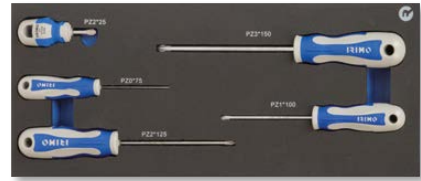

- Pozidriv and Stubby screwdrivers
- 5 pieces

IFF1E009	1	445 x 181 x 40

413-0-75, 413-1-100, 413-2-125, 413-3-150	
413-2-25	

IFF1E010

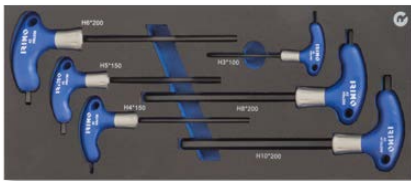

- T-Handle hexagonal screwdrivers
- 6 pieces

IFF1E010	1	445 x 181 x 40

42-H3-100, 42-H4-150, 42-H5-150, 42-H6-200, 42-H8-200, 42-H10-200	
---	--

IFF1E011

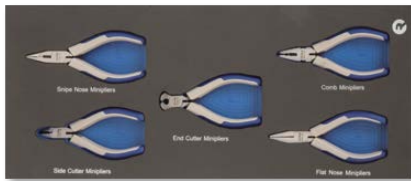

- Minipliers
- 5 pieces

IFF1E011	1	445 x 181 x 40

601M-125-1	
612M-125-1	
624M-125-1	
626M-125-1	
604M-125-1	

IFF1E012

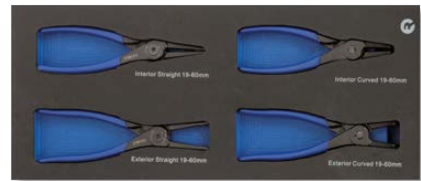

- Circlip pliers exterior and interior
- 4 pieces

IFF1E012	1	445 x 181 x 40

621571	
621671	
621771	
621871	

TROLLEY FOAMS 1/3 SYSTEM

IFF1E013

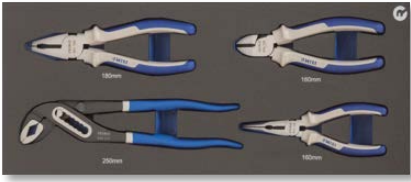

- Pliers
- 4 pieces



IFF1E013 1 445 x 181 x 40

601-180-1	
624-160-1	
612-160-1	
634-250-1	

IFF1E014

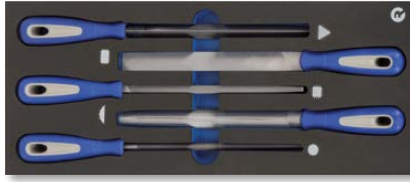

- Files
- 5 pieces



IFF1E014 1 445 x 181 x 40

534411	
534351	
534321	
534291	
534381	

IFF1E015



- Socket set 1/2", sliding T-Handle, ratchet
- 21 pieces



IFF1E015 1 445 x 181 x 40

121-10-1, 121-11-1, 121-12-1, 121-13-1, 121-14-1, 121-15-1, 121-16-1, 121-17-1, 121-18-1, 121-19-1, 121-21-1, 121-22-1, 121-23-1, 121-24-1, 121-27-1, 121-30-1, 121-32-1	
125-70-1	
125-42-1	
125-23-1	
125-25-1	

IFF1E016



- Socket set 1/4", T-Handle, extensions, ratchet
- 18 pieces



IFF1E016 1 445 x 181 x 40

101-04-1, 101-045-1, 101-05-1, 101-055-1, 101-06-1, 101-07-1, 101-08-1, 101-09-1, 101-10-1, 101-11-1, 101-12-1, 101-13-1, 101-14-1	
105-70-1	
105-42-1	
105-50-1	
105-22-1	
105-24-1	

IFF1E017

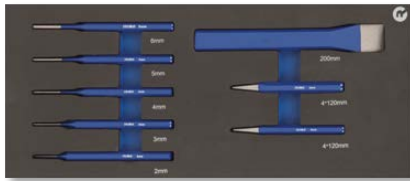

- Pin punches and chisel
- 8 pieces



IFF1E017 1 445 x 181 x 40

504-200-1	
516-002-1, 516-003-1, 516-004-1, 516-005-1, 516-006-1	
512-010-1, 512-012-1	

IFF1E018



- Striking and cutting tools
- 4 pieces



IFF1E018 1 445 x 181 x 40

529171	
527-51-2	
982-TOR-1	
668-150-1	



IFF1E019



- Bit set 1/4", measuring tape, battery
- 72 pieces

IFF1E019 1 445 x 181 x 40

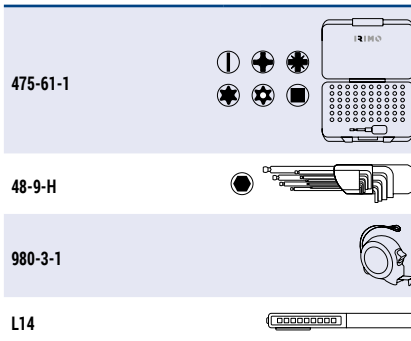

IFF1E024

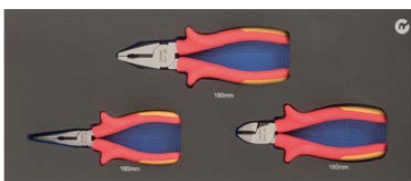

- Insulated pliers and cutter
- 3 pieces

IFF1E024 1 445 x 181 x 40

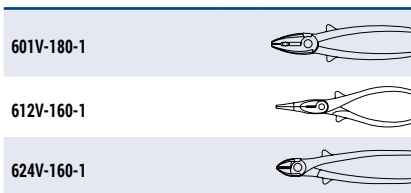

IFF1E021



- Stud extractor and pullers
- 8 pieces

IFF1E021 1 445 x 181 x 40

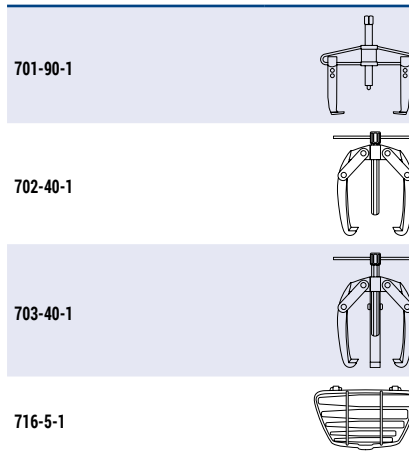

IFF1E025



- Insulated 1000V screwdrivers
- 6 pieces

IFF1E025 1 445 x 181 x 40

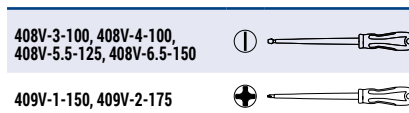

IFF1E023



- Adjustable central nut and slip joint plier
- 2 pieces

IFF1E023 1 445 x 181 x 40

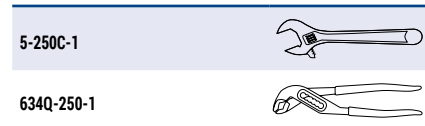

TOOL TROLLEYS

3 TOOL BOXES TOWER ON WHEELS



YouTube

- Multiple compartments provide large storage capacity allowing easy organization of tools
- Combination of steel and PP plastic provides robustness but light
- On wheels solution, together with the telescopic handle, makes its driving easy even when very loaded
- Rubber wheels dim: 125 x 35 mm
- Locking bar with padlock for full locking included
- The 3 compartments can be attached and detached easily with the lateral metallic latches
- **Top compartment:**
int dim: 485 x 225 x 210 mm
Can be used as an independent tool box and it can be locked using a padlock
Alu big handle makes its transport easy and comfortable
Retractable side handles help to lift when very loaded
Portable tray included 450 x 185 x 45 mm
- **Medium compartment:**
int dim of 2 drawers: 390 x 215 x 60 mm
2 Drawers with ball bearing sliders and full extension, also padlockable
- **Bottom compartment:**
int dim: 403 x 200 x 265 mm
Drawer pivots giving full access and making the storage hose reels, drills and similar big tools/ accessories easy
- Telescopic handle is permanently attached to the bottom compartment and has 4 positions: 995 mm, 900 mm, 800 mm and 645 mm
- External dim: 520 x 320 x 720 mm

R	mm	kg	
9021FTW520	1	520 x 320 x 720	15

SPARE PARTS

9021FTW520-AC1	2 wheels & spindle	125 x 35 mm
9021FTW520-AC2	Lock for tower	
9021FTW520-AC3	4 latches tower	
9021FTW520-AC4	Telescopic handle	
9021FTW520-AC5	Aluminium handle topbox	

TOWER 3 IN 1 WITH FOAM AND TOOLS , 98 pieces



R	mm	kg	
9021FTW520FF1	1	520 x 320 x 720	22.5
101-04-1, 101-045-1, 101-05-1, 101-055-1, 101-06-1, 101-07-1, 101-08-1, 101-09-1, 101-10-1, 101-11-1, 101-12-1, 101-13-1, 101-14-1			1/4
121-08-1, 121-10-1, 121-11-1, 121-12-1, 121-13-1, 121-14-1, 121-16-1, 121-17-1, 121-19-1, 121-21-1, 121-22-1			1/2
105-70-1		475-1/4-125	
105-40-1		105-50-1	
105-22-1		105-24-1	
105-42-1		125-70-1	
125-40-1		125-43-1	
125-23-1		125-25-1	
46-8-F		475-32-1	
980-3B-1			
407-5.5-125		409-1-100	
407-6.5-150		409-2-125	
612-160-1		601-180-1	
625-180-1		604-160-1	
5-250C-1		522-31-2	
634-250-1		665-200-1	
25-08-1, 25-09-1, 25-10-1, 25-11-1, 25-12-1, 25-13-1, 25-14-1, 25-17-1, 25-19-1			

9021FTW520

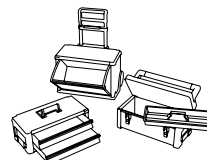

2 TRAYS ROLL CART



- 2 tray set roll cart
- Manufactured and designed for easy and quick assembly
- Wheels of 100 x 25 mm with ball bearings and non-marking TPR outsurface:
2 fixed and 2 swivel with brake
- Trays internal dimensions:
(2x) 750 x 425 x 77 mm

9064K-02	1	759 x 432 x 1.025	300	759 x 432 x h	50	25 x 100 19

1 MIDDLE TRAY FOR 9064K-02 ROLL CART



- 1 middle tray to be assembled in 9064K-02 roll cart
- Manufactured and designed for quick and easy assembly
- Tray internal dimensions:
750 x 425 x 77 mm

9064K-02T	1	757 x 425 x 77	50			3.25

TRANSPORTERS

TRANSPORTER



150 kg
9063HT150

300 kg
9063HT300

- Strong Steel frame
- Steel plate provide high robustness
- Wheels: 2 fixed and 2 rear swivel for easy maneuverings
- Push/pull handle that folds for easy storage and carriage
- Non-slip platform surface
- Overall size 150 kgs:
 - Unfolded: 730 x 470 x 820 mm
 - Folded: 730 x 470 x 225 mm
- Overall size 300 kgs:
 - Unfolded: 920 x 620 x 870 mm
 - Folded: 920 x 620 x 300 mm

9063HT150	1	730 x 470	150	25 x 100		7.5
9063HT300	1	920 x 620	300	25 x 125		15.0

FOLDABLE TRANSPORTER



- Robust
- Elastic bands included to fix the load (safety feature)
- Steel frame
- 250 x 450 mm aluminum footplate
- 170 mm PP wheels
- Overall size:
480 x 420 x 740-1000 mm

9063FT90	1	250 x 450	90	170		4.3

METALLIC TOOL BOXES

TWO HANDLE MODEL



902021 / 902031



902131

- Cantilever style tool box with fixed handles for easy opening
- Tube type handle is user friendly, specially if the box is very loaded
- Fixed dividers in the top trays make the small pieces storage comfortable and easy
- Hinge system allows easy opening of the lids and avoids dust entering the tool box
- The box can be locked by padlock
- All corners are bent or ground to avoid sharp edges
- Made of high degree metal sheet, ensures product performance and longevity

R					
902021	1	400 x 210 x 190	3	8	3.4
902031	1	500 x 210 x 190	3	10	4.1
902131	1	500 x 210 x 245	5	12	5.4

ONE HANDLE MODEL



9020F550

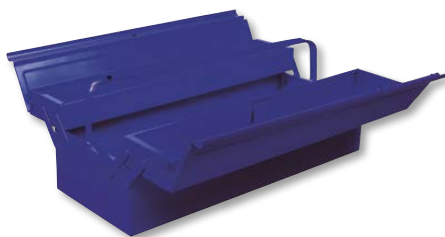

9020F350

- Cantilever style tool box with foldable handle that makes easy to stack on
- Cantilever style tool box with foldable suitable for stacking
- Tube type handle is user friendly, specially if the box is very loaded
- Fixed dividers in the top trays make for easy storage
- Riveted lids make the opening easy and avoids dust to come in
- The box can be locked by padlock
- Made of high degree metal sheet, ensures product performance and longevity

R					
9020F350	1	530 x 200 x 160	3	8	3.6
9020F550	1	530 x 200 x 200	5	10	4.7

GENERAL MAINTENANCE KIT, 67 pieces



9020F550TS10	1	200 x 530 x 200	12 kg

121-10-1, 121-11-1, 121-12-1, 121-13-1, 121-14-1, 121-15-1, 121-16-1, 121-17-1, 121-18-1, 121-19-1, 121-20-1, 121-21-1, 121-22-1, 121-23-1, 121-24-1, 121-27-1, 121-30-1, 121-32-1				
25-08-2, 25-09-2, 25-10-2, 25-11-2, 25-12-2, 25-13-2, 25-14-2, 25-15-2, 25-16-2, 25-17-2, 25-18-2, 25-19-2				
407-4-100		409-1-100		
407-5.5-125		409-2-125		
408-5.5-125		409-3-150		
408-6.5-150		409-2-25		
408-5.5-25		64A-235-1		
634-250-1		624-160-1		
601-200-1		612-200-1		
522-43-2		529161		
505-150-1		501-150-1		
517-130-1		517-140-1		
511-110-1		48-9-H		
125-70-1		125-40-1		
125-25-1		125-23-1		
125-52-1		Z150003		
980-5-1		9020F550		

GENERAL MAINTENANCE KIT, 95 pieces



9020F550FF95	1	530 x 200 x 200	12.8 kg

1 & 2 = 90 x 258 mm

1	121-10-1, 121-11-1, 121-12-1, 121-13-1, 121-14-1, 121-15-1, 121-16-1, 121-17-1, 121-18-1, 121-19-1, 121-20-1, 121-21-1, 121-22-1, 121-23-1	
2	121-24-1, 121-27-1, 121-30-1, 121-32-1	
48-9-H		

3, 5 & 6 = 90 x 525 mm

3	624-160-1	
3	601-180-1	
	612-200-1	
	475R-1/4-110	
5	648-250-1	
	666-156-1	
6	25-08-2, 25-09-2, 25-10-2, 25-11-2, 25-12-2, 25-13-2, 25-14-2, 25-15-2, 25-16-2, 25-17-2, 25-18-2, 25-19-2	

4 = 195 x 525 mm

125-70-1		125-23-1	
125-40-1		125-52-1	
4	520-43-2	475-32A-1	
980-5-1			

9020F550



METALLIC TOOL BOXES

ALUMINIUM TOOL CASE WITH TOOLS, 97 pieces



Code	Qty	Dimensions (mm)	Weight (kg)
9024-TTS1	1	460 x 115 x 365	8.8
101-04-1, 101-045-1, 101-05-1, 101-055-1, 101-06-1, 101-07-1, 101-08-1, 101-09-1, 101-10-1, 101-11-1, 101-12-1, 101-13-1, 101-14-1			1/4"
121-08-1, 121-10-1, 121-11-1, 121-12-1, 121-13-1, 121-14-1, 121-16-1, 121-17-1, 121-19-1, 121-21-1, 121-22-1			1/2"
25-08-2, 25-09-2, 25-10-2, 25-11-2, 25-12-2, 25-13-2, 25-14-2, 25-17-2, 25-19-12			
407-5.5-125		409-1-100	
407-6.5-150		409-2-125	
105-70-1		105-50-1	
105-40-1		105-42-1	
105-22-1		105-24-1	
125-70-1		125-40-1	
125-23-1		125-25-1	
125-43-1			
46-8-F		475-32-1	
5-250C-1		604-160-1	
612-160-1		601-180-1	
625-180-1		634-250-1	
522-31-2		665-200-1	
980-3B-1			

ALUMINIUM TOOL CASE WITH TOOLS, 145 pieces



Code	Qty	Dimensions (mm)	Weight (kg)
9024-TTS145	1	450 x 115 x 290	12.5
101-04-1, 101-045-1, 101-05-1, 101-055-1, 101-06-1, 101-07-1, 101-08-1, 101-09-1, 101-10-1, 101-11-1, 101-12-1, 101-13-1, 101-14-1			1/4"
121-08-1, 121-10-1, 121-11-1, 121-12-1, 121-13-1, 121-14-1, 121-15-1, 121-16-1, 121-17-1, 121-18-1, 121-19-1, 121-21-1, 121-22-1, 121-24-1, 121-27-1, 121-30-1, 121-32-1			1/2"
25-08-2, 25-09-2, 25-10-2, 25-11-2, 25-12-2, 25-13-2, 25-14-2, 25-15-2, 25-16-2, 25-17-2, 25-18-2, 25-19-2			
105-70-1		105-50-1	
105-22-1		105-24-1	
105-40-1		105-42-1	
105-48-1		5-250C-1	
125-23-1		125-25-1	
125-70-1		125-40-1	
125-43-1		125-53-1, 125-54-1	
46-8-F		475-61-1	
801-041-1		980-5-1	
666-156-1		665-200-1	
520-43-2		L-ALUM-1	
634-250-1		632-220-1	
624-160-1		601-180-1	
612-160-1		604-160-1	
984-6D-1		475-5-1	



PLASTIC BOX - LOOSE KIT, 48 pieces



Code	Quantity	Dimensions	Weight		
9023PT565TS1	1	170 x 565 x 302	10		
408V-3-100	1		408V-4-100	1	
408V-5.5-125	1		408V-6.5-150	1	
409V-1-150	1		409V-2-175	1	
601V-180-1	1		612V-160-1	1	
624V-160-1	1		629V-160-1	1	
634V-250-1	1		429-03-1	1	
5-200C-1	1		661051	1	
801-145-1	1		666-156-1	1	
980-3-1	1		475-32-1	1	
9023PT565	1				

PLASTIC TOOL BOX



- Double deck plastic tool box
- Upper side: 18 compartments to storage small items
- Transparent resistant cover
- Locking handle system with two metallic latches
- Stainless tube handle with plastic grip for better comfort and easy carrying

Code	Quantity	Dimensions	Weight
9023PT565	1	170 x 565 x 320	2.4

FABRIC BAGS

TOOL BAG WITH TUBULAR HANDLE



- 17" Open style bag for easy quick view and accessibility
- Soft bottom reinforced with plastic feet
- Hard waterproof bottom
- 11 Different vertical side pouches for better tool organization
- Aluminum handle for strengthening the structure with foam grip
- Detachable shoulder strap with cushion on the adjustable shoulder part for easier transportation
- 600x300 Denier fabric ensures product performance and longevity
- Delivered folded

9022-1-16SB	1	440 x 210 x 310	21	15	1.5

TOOL BAG WITH TUBULAR HANDLE



- 19" Open style bag for easy quick view and accessibility
- Soft bottom reinforced with plastic feet
- Hard waterproof bottom
- 12 Different vertical side pouches inside and outside for better tool organization and measuring tape holder
- Internal detachable panel with 10 pouches and elastics for tool holding
- Specific Velcro straps for spirit levels or any other long tool
- Aluminum handle for strengthening the structure with foam grip
- Detachable shoulder strap with cushion on the adjustable shoulder part for easier transportation
- 600x300 Denier fabric ensures product performance and longevity
- Delivered folded

9022-1-19HB	1	490 x 240 x 350	32	20	1.5

TOOL BAG WITH ZIP



- 16" Bag with zip closing system for quick view and accessibility
- Hard waterproof bottom
- 10 External divers size pouches and 14 internal vertical pouches for better tool organization
- Some external pouches are covered for better protecting and a measuring tape holder is also included
- Detachable shoulder strap with cushion on the adjustable shoulder part
- 600x300 Denier fabric ensures product performance and longevity

9022-2-16HB	1	420 x 240 x 300	24	18	1.2

TOOL BAG WITH ZIP



- 19" Bag with zip closing system for quick view and accessibility
- Hard waterproof bottom
- 17 External divers size pouches and 14 internal vertical pouches for better tool organization
- Some external pouches are covered for better protecting and a measuring tape holder is also included
- Detachable shoulder strap with cushion on the adjustable shoulder part
- 600x300 Denier fabric ensures product performance and longevity

9022-2-19HB	1	490 x 240 x 370	35	20	1.5

TOOL BAG WITH COMPOSITION, 73 pieces



Code	Quantity	Dimensions	Weight (kg)
9022-2-16HBS2	1	420 x 240 x 300	5.3
109-13-4		475-32-1	
48-9-H		459-6-B	
602-3-C		801-041-1	
980-5-1		10-8-H	
9022-2-16HB			

LAPTOP AND TOOL BACK-PACK

[YouTube](#)



* The bag comes without tools

- Big storage capacity: 20 litres and 16 kilos, thanks to several pouches and detachable tool organizer
- Specific laptop compartment
- Detachable part: 10 pockets provides a better tool distribution
- Smartphone pocket within frontal compartment

Code	Quantity	Dimensions	Volume (L)	Weight (kg)
9022-BP1	1	300 x 450 x 175	20	1.93

BACK-PACK WITH WHEELS

[YouTube](#)



* The bag comes without tools

- Telescopic handle and 2 fixes wheels for easy transportation
- Big storage capacity: 26 litres and 20 kilos, thanks to several internal/external pouches and detachable tool organizer
- Detachable organizer with 2 handles: 51 pockets of different sizes providing a better tool distribution
- Measuring tape holder

Code	Quantity	Dimensions	Volume (L)	Weight (kg)
9022-BPW	1	360 x 440 x 220	26	20



POUCHES, BELTS AND FOLDERS

FOLDER – EMPTY



- Multiple elastics in bottom and lid for better tool distribution
- Double zip
- Rubber soft handle
- Net on the lid for documentation

9022-4-26	1	258 x 55 x 258	810

FOLDER – EMPTY



- Multiple elastics in bottom and lid for better tool distribution
- Double zip
- Rubber soft handle
- Net on the lid for documentation

9022-4-35	1	353 x 50 x 310	810

FOLDER – WITH 18 TOOLS



9022-4-26TS1	1	258 x 55 x 258	1.5

475R-1/4-110		5-200C-1	
624-140-1		601-160-1	
982-TOR-1		980-3-1	
9022-4-26			

FOLDER – WITH 28 TOOLS



9022-4-35TS1	1	353 x 50 x 310	3

475R-1/4-110		46-9-H	
5-200C-1		624-160-1	
601-160-1		520-43-2	
668-150-1		980-5-1	
9022-4-35			



HAMMER HOLDER



9022-3-20	1	170 x 70 x 120	120

PLIER POUCH



9022-3-30	1	260 x 95	40

STRIKING SET



9022-3-20TS1	1	790

9022-3-20		520-43-2	
-----------	--	----------	--

ELECTRICIAN 4 PIECES SET IN POUCH



9022-3-30TS1	1	260 x 95 x 30	580

407-4-100		409-1-100	
601-180-1		668-150-1	
9022-3-30			

STRIKING SET



9022-3-20TS2	1	790

9022-3-20		520-41-2	
-----------	--	----------	--

ELECTRICIAN 4 PIECES SET IN POUCH



9022-3-30TS2	1	260 x 95 x 30	550

407-4-100		409-1-100	
624-160-1		668-150-1	
9022-3-30			

POUCHES, BELTS AND FOLDERS

TOOL POUCH



9022-3-40	1	290 x 10 x 150	60

10 POCKETS TOOL POUCH



9022-3-50	1	260 x 70 x 355	480

MRO 7 PIECES SET IN POUCH



9022-3-40TS1	1	290 x 60 x 150	1000

407-6.5-150		409-2-125	
624-140-1		601-160-1	
665-200-1		5-150C-1	
9022-3-40		980-3-1	

MRO 9 PIECES SET IN POUCH



9022-3-50TS1	1	260 x 95 x 355	2400

407-5.5-125		409-1-100	
407-6.5-150		409-2-125	
520-43-2		634-250-1	
624-160-1		982-TOR-1	
9022-3-50		980-5-1	

INSULATED 7 PIECES SET IN POUCH



9022-3-40TS2	1	290 x 60 x 150	1000

408V-4-100		409V-1-150	
624V-160-1		612V-160-1	
665-200-1		5-150C-1	
9022-3-40		980-3-1	

ADJUSTABLE BELT



9022-3-10	1	1500 x 10 x 75	200

A full-page photograph of a male mechanic with a beard, wearing a blue work uniform, looking upwards while working on a car engine. He is holding a silver adjustable wrench in his left hand. The background is dark and industrial, with a blurred car part visible in the lower left. A yellow horizontal band with a distressed, cracked texture is overlaid across the middle of the image, containing the section header text.

02. WRENCHES

ADJUSTABLE WRENCHES

HEAVY DUTY ADJUSTABLE WRENCH

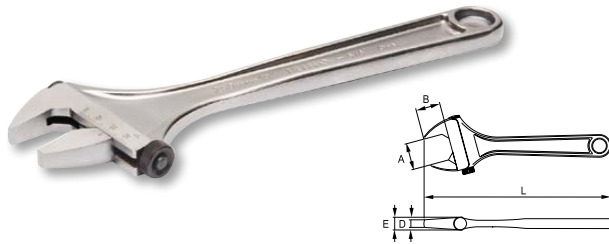

- Material: CrV
- Finish: Chrome-plated matt finished
- Hardness: 40-45 HRC
- Jaws angled at 15° to give good access even in confined spaces
- Standards: UNE 16532, ISO 6787, DIN 3117

Q	Icon	Wrench	A mm	B mm	D mm	E mm	L mm	g
001021	5	150 mm - 6"	21	18.5	6.5	12	155	140
001031	5	200 mm - 8"	29	26	8	14	205	290
001041	5	250 mm - 10"	34	32	9	17	255	510
001051	3	300 mm - 12"	39	36	10	20	305	795
001061	1	400 mm - 16"	49	44	14	26	405	1.620
001071	1	500 mm - 20"	62	53	17	30	500	2.860
001081	1	750 mm - 30"	78	70	23	37	750	5.550

CENTRAL NUT

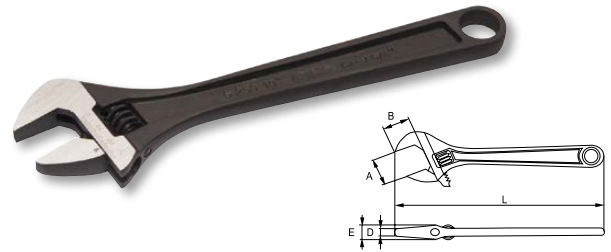

- Material: CrV
- Black finish
- Hardness: 40-45 HRC
- Jaws angled at 15° to give access even in confined spaces
- Standards: UNE 16532, ISO 6787, DIN 3117
- -1 Retail packaging
- -2 Industrial packaging

Q	Icon	Wrench	A mm	B mm	D mm	E mm	L mm	g
5-100-1	5	100 mm - 4"	13	13.5	3.5	9	115	60
5-150-1	5	150 mm - 6"	20	21	5.5	12	160	130
5-200-1	5	200 mm - 8"	24	26	7.5	13.5	205	250
5-250-1	5	250 mm - 10"	29	29.5	9	16	260	405
5-300-1	5	300 mm - 12"	36	36	11	19	310	650
5-100-2	60	100 mm - 4"	13	13.5	3.5	9	115	60
5-150-2	50	150 mm - 6"	20	21	5.5	12	160	130
5-200-2	40	200 mm - 8"	24	26	7.5	13.5	205	250
5-250-2	30	250 mm - 10"	29	29.5	9	16	260	405
5-300-2	20	300 mm - 12"	36	36	11	19	310	650
5-375-2	1	375 mm - 15"	43	45	13	24	385	1.230
5-450-2	1	450 mm - 18"	57	53	15	27.5	465	2.000

CENTRAL NUT

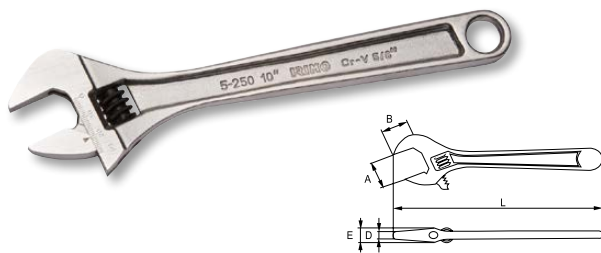

- Material: CrV
- Finish: Chrome-plated
- Hardness: 40-45 HRC
- Jaws angled at 15° to give good access even in confined spaces
- Standards: UNE 16532, ISO 6787, DIN 3117
- -1 Retail packaging
- -2 Industrial packaging

Q	Icon	Wrench	A mm	B mm	D mm	E mm	L mm	g
5-100C-1	5	100 mm - 4"	13	13.5	3.5	9	115	60
5-150C-1	5	150 mm - 6"	20	21	5.5	12	160	130
5-200C-1	5	200 mm - 8"	24	26	7.5	13.5	205	250
5-250C-1	5	250 mm - 10"	29	29.5	9	16	260	405
5-300C-1	5	300 mm - 12"	36	36	11	19	310	650
5-375C-2	1	375 mm - 15"	43	45	13	24	385	1.230
5-450C-2	1	450 mm - 18"	57	53	15	27.5	465	2.000

PHOSPHATED ADJUSTABLE WRENCH SET



- Material: CrV; Black finish
- Hardness: 40-45 HRC
- Jaws angled at 15° to give access even in confined spaces
- Standards: UNE 16532, ISO 6787, DIN 3117

Q	Icon	Wrench	g	
5-4-W	1	4	50 x 330 x 110	1.500

5-150-2, 5-200-2, 5-250-2, 5-300-2



STUBBY ADJUSTABLE WRENCH DISPLAY, 12 pieces



- Comfortable bi-material handle
- Metric scale laser marked on front side
- Jaw opening: 24 mm (same as 200 mm length wrench)
- Full length: 161 mm
- Surface finish: chrome Plated
- Material: high quality CrV steel
- Hardness: 40-50 HRC
- Standards: UNE 16532, ISO 6787, DIN 3117
- 5-STB: Loose Stubby Adjustable Wrench

5-STB-12DISP	1	12	160 x 150 x 230	2.590

OPEN END WRENCHES

DOUBLE OPEN END WRENCHES

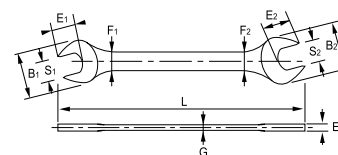

- Material: High performance alloy steel, CrV
- Finish: Chrome-plated matt finished
- Hardness: 42-50 HRC
- Standards: DIN 3110, ISO 10102, ISO 1085, ISO 1711, ISO 691, ISO 3318

		S1 x S2 mm	L mm	B1 mm	B2 mm	F1 mm	F2 mm	E1 mm	E2 mm	E mm	G mm	
10-0405-1	1	4 x 5	105	13	15	6.5	7.5	7.2	7	3.2	2.5	15
10-0607-1	1	6 x 7	122	17.4	19.4	7.5	8.5	8.1	9	4.1	2.8	21
10-0809-1	1	8 x 9	137	20.4	22.4	8.5	9.5	10.5	11.2	4.6	3.3	30
10-1011-1	1	10 x 11	151.4	24.2	27.2	10.5	11.5	11.6	13.3	5.4	3.8	46
10-1013-1	1	10 x 13	151.4	24.2	37.2	10.5	11.5	11.6	13.3	5.4	3.8	46
10-1213-1	1	12 x 13	166.5	29.4	31.4	12.5	13.5	13.6	15.3	6.1	4	66
10-1415-1	1	14 x 15	182	32.4	35.4	13.5	14.5	16	17.5	6.5	4.4	95
10-1617-1	1	16 x 17	196.5	36.4	38.4	15.5	16.5	18.5	19.6	6.9	4.8	124
10-1719-1	1	17 x 19	221	40.4	42.4	16.5	18.5	20.8	22.4	7.4	5.1	160
10-1819-1	1	18 x 19	211.9	40.4	42.4	16.5	18.5	20.8	21.2	7.4	5.1	157
10-2022-1	1	20 x 22	226.9	43.4	47.4	18.5	19.5	23.3	24.5	8.6	5.6	188
10-2123-1	1	21 x 23	241.9	46.4	50.4	18.5	20.5	23.6	26	9.2	5.8	211
10-2224-1	1	22 x 24	241.9	46.4	50.4	18.5	20.5	23.6	26	9.2	5.8	208
10-2426-1	1	24 x 26	261.9	50.4	54.4	21.5	23.5	27.9	29.8	10	6.2	293
10-2427-1	1	24 x 27	261.9	50.4	54.4	21.5	23.5	27.9	29.8	10	6.2	284
10-2528-1	1	25 x 28	281.9	54.4	59.4	23.5	24.5	28.6	30.7	10.6	6.6	366
10-2729-1	1	27 x 29	282.4	54.6	59.6	23.5	24.5	28.6	30.7	10.6	6.6	362
10-3032-1	1	30 x 32	302.9	61.4	68.4	24.5	26.5	33.4	35.5	11	7	481

OPEN END WRENCHES

DOUBLE OPEN END WRENCH SET



- Material: High performance alloy steel, CrV
- Finish: Chrome-plated matt finished
- Hardness: 42-50 HRC
- Standards: DIN 3110, ISO 10102, ISO 1085, ISO 1711, ISO 691, ISO 3318

10-8-H	1	8	250 x 120 x 50	870
10-0607-1, 10-0809-1, 10-1011-1, 10-1213-1, 10-1415-1, 10-1617-1, 10-1819-1, 10-2022-1				

DOUBLE OPEN END WRENCH SET



- Material: High performance alloy steel, CrV
- Finish: Chrome-plated matt finished
- Hardness: 42-50 HRC
- Standards: DIN 3110, ISO 10102, ISO 1085, ISO 1711, ISO 691, ISO 3318

10-12-H	1	12	350 x 150 x 70	2.975
10-0607-1, 10-0809-1, 10-1011-1, 10-1213-1, 10-1415-1, 10-1617-1, 10-1819-1, 10-2022-1, 10-2123-1, 10-2426-1, 10-2528-1, 10-3032-1				

DOUBLE OPEN END WRENCH SET



- Material: High performance alloy steel, CrV
- Finish: Chrome-plated matt finished
- Hardness: 42-50 HRC
- Standards: DIN 3110, ISO 10102, ISO 1085, ISO 1711, ISO 691, ISO 3318

10-12-W	1	12	400 x 140 x 100	2.975
10-0607-1, 10-0809-1, 10-1011-1, 10-1213-1, 10-1415-1, 10-1617-1, 10-1819-1, 10-2022-1, 10-2123-1, 10-2426-1, 10-2528-1, 10-3032-1				

COMBINATION WRENCHES

COMBINATION WRENCHES IN MM

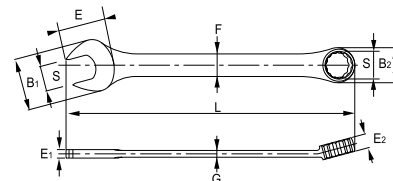

- Material: High performance alloy steel, CrV
- Finish: Chrome-plated matt finished
- Hardness: 42-50 HRc
- Standards: DIN 3113, ISO 1711-1, ISO 3318, ISO 691, ISO 7738
- -1 Retail packaging
- -2 Industrial packaging

R	S	L	B1	B2	F	E	E1	E2	G	g
25-06-1	6	103	15.7	10.6	6.2	7.9	3.7	5.2	3	15
25-07-1	7	109	18	12.1	6.8	8.2	3.7	5.5	3	17
25-08-1	8	119	18.8	13.6	6.8	9.9	4.0	6	3.3	21
25-09-1	9	124	21	15.1	7.9	10.4	4.0	6.8	3.4	26
25-10-1	10	134	22.8	16.2	8.6	10.7	4.8	7	3.6	38
25-11-1	11	143	25.8	17.1	9.1	12.6	4.8	7.5	3.6	39
25-12-1	12	154	27.8	18.9	10	13.2	5.2	8	4.2	51
25-13-1	13	164	29.8	20.2	11.5	14.6	5.2	8.3	4.2	63
25-14-1	14	174	29.8	21.2	11.4	15.8	5.8	8.9	4.6	68
25-15-1	15	183	34.1	22.3	12.2	16.9	5.8	8.9	4.6	85
25-16-1	16	194	35.1	23.8	13.2	17.6	6.3	9.5	5	107
25-17-1	17	203	37.2	25.3	14.4	18.6	6.3	10	5	118
25-18-1	18	214	39.2	26.8	14.4	20.5	6.7	10.5	5.2	137
25-19-1	19	228	41.4	28.3	15.8	21.1	7.0	11.2	5.2	163
25-20-1	20	240	42.4	29.7	17.3	22.8	7.5	11.4	5.5	186
25-21-1	21	249.5	45.4	32.4	17.3	22.8	8.6	12.6	6	210
25-22-1	22	249.5	45.4	32.4	17.3	22.8	8.6	12.2	6	202
25-23-1	23	270	49.7	36.1	20.3	25	9.2	13.6	6.4	281
25-24-1	24	270	49.7	36.1	20.3	25	9.2	13.6	6.4	276
25-25-1	25	289.5	53.4	39.6	22.5	27.6	9.6	14.2	6.8	346
25-26-1	26	289.5	53.4	39.6	22.5	27.6	9.6	14.2	6.8	345
25-27-1	27	310	58.4	41.6	23.3	29.5	10.0	14.6	7.2	382
25-28-1	28	310	58.4	41.6	23.3	29.5	10.0	14.6	7.2	402
25-29-1	29	330	60.4	45.6	23.3	32.1	10.6	15.6	7.6	476
25-30-1	30	330	60.4	45.6	23.3	32.1	10.6	15.6	7.6	468
25-32-1	32	349	67.4	48.8	25.3	35.6	11.2	17.8	8	567
25-34-1	34	350	67.4	48.8	25.3	35.6	11.2	17.8	8	541

R	S	L	B1	B2	F	E	E1	E2	G	g
25-06-2	6	103	15.7	10.6	6.2	7.9	3.7	5.2	3	15
25-07-2	7	109	18	12.1	6.8	8.2	3.7	5.5	3	17
25-08-2	8	119	18.8	13.6	6.8	9.9	4.0	6	3.3	21
25-09-2	9	124	21	15.1	7.9	10.4	4.0	6.8	3.4	26
25-10-2	10	134	22.8	16.2	8.6	10.7	4.8	7	3.6	38
25-11-2	11	143	25.8	17.1	9.1	12.6	4.8	7.5	3.6	39
25-12-2	12	154	27.8	18.9	10	13.2	5.2	8	4.2	51
25-13-2	13	164	29.8	20.2	11.5	14.6	5.2	8.3	4.2	63
25-14-2	14	174	29.8	21.2	11.4	15.8	5.8	8.9	4.6	68
25-15-2	15	183	34.1	22.3	12.2	16.9	5.8	8.9	4.6	85
25-16-2	16	194	35.1	23.8	13.2	17.6	6.3	9.5	5	107
25-17-2	17	203	37.2	25.3	14.4	18.6	6.3	10	5	118
25-18-2	18	214	39.2	26.8	14.4	20.5	6.7	10.5	5.2	137
25-19-2	19	228	41.4	28.3	15.8	21.1	7.0	11.2	5.2	163
25-20-2	20	240	42.4	29.7	17.3	22.8	7.5	11.4	5.5	186
25-21-2	21	249.5	45.4	32.4	17.3	22.8	8.6	12.6	6	210
25-22-2	22	249.5	45.4	32.4	17.3	22.8	8.6	12.2	6	202
25-23-2	23	270	49.7	36.1	20.3	25	9.2	13.6	6.4	281
25-24-2	24	270	49.7	36.1	20.3	25	9.2	13.6	6.4	276
25-25-2	25	289.5	53.4	39.6	22.5	27.6	9.6	14.2	6.8	346
25-26-2	26	289.5	53.4	39.6	22.5	27.6	9.6	14.2	6.8	345
25-27-2	27	310	58.4	41.6	23.3	29.5	10.0	14.6	7.2	382
25-28-2	28	310	58.4	41.6	23.3	29.5	10.0	14.6	7.2	402
25-29-2	29	330	60.4	45.6	23.3	32.1	10.6	15.6	7.6	476
25-30-2	30	330	60.4	45.6	23.3	32.1	10.6	15.6	7.6	468
25-32-2	32	349	67.4	48.8	25.3	35.6	11.2	17.8	8	567
25-34-2	34	350	67.4	48.8	25.3	35.6	11.2	17.8	8	541
25-36-2	36	401	74	54	31	62	10.4	17	8	787
25-41-2	41	436	82	61	34	70	12	19.5	8	1.070
25-46-2	46	556	92	66	33.6	79.8	15	23	11	1.750
25-50-2	50	602	100	73	36.6	86.7	17	26	12	2.200
25-55-2	55	612	113	84	42	94	18	28	14.5	3.070
25-60-2	60	660	125	90	47	100	20	30	16	3.500
25-65-2	65	710	132	98	52	110	21	34	18	4.750
25-70-2	70	760	140	102	52	110	22	35	18	5.550
25-75-2	75	810	150	108	55	120	25	38	19	6.800
25-80-2	80	820	179	131	60	120	30	38	20	10.000
25-85-2	85	820	179	131	60	120	30	38	20	10.000
25-90-2	90	790	179	131	60	120	30	38	20	10.000
25-95-2	95	860	187	145	62	120	32	43	20	12.000
25-100-2	100	860	187	145	62	120	32	43	20	12.000

COMBINATION WRENCHES

COMBINATION WRENCHES IN INCHES

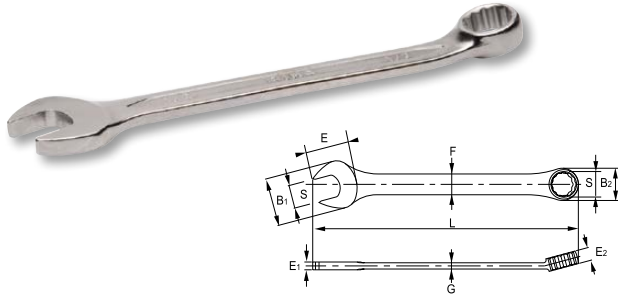

- Material: High performance alloy steel, CrV
- Finish: Chrome-plated matt finished
- Hardness: 42-50 HRC
- Standards: DIN 3113, ISO 1711-1, ISO 3318, ISO 691, ISO 7738
- -1 Retail packaging
- -2 Industrial packaging

IRIMO	Box	S mm	L mm	B1 mm	B2 mm	F mm	E mm	E1 mm	E2 mm	G mm	g
25A-08-1	1	1/4"	103	15.9	10.6	6.6	7.9	3.7	5.2	3	15
25A-10-1	1	5/16"	119	19	13.6	7.2	9.9	4	6	3.3	21
25A-12-1	1	3/8"	124	21.2	15.1	8.3	10.4	4	6.8	3.4	26
25A-14-1	1	7/16"	143	26	17.1	9.5	12.6	4.8	7.5	3.6	39
25A-16-1	1	1/2"	164	30	20.2	11.9	14.6	5.2	8.3	4.2	63
25A-18-1	1	9/16"	174	30	21.2	11.8	15.8	5.8	8.9	4.6	68
25A-20-1	1	5/8"	194	35.3	23.8	13.6	17.6	6.3	9.5	5	107
25A-22-1	1	11/16"	214	39.4	26.8	14.8	20.5	6.7	10.5	5.2	137
25A-24-1	1	3/4"	228	41.6	28.3	16.2	21.1	7	11.2	5.2	163
25A-26-1	1	13/16"	249.5	45.4	32.4	17.3	22.8	8.6	12.6	6	210
25A-28-1	1	7/8"	249.5	45.4	32.4	17.3	22.8	8.6	12.6	6	210
25A-30-1	1	15/16"	270	49.7	36.1	20.3	25	9.2	13.6	6.4	281
25A-32-1	1	1"	289.5	53.4	39.6	22.5	27.6	9.6	14.2	6.8	346
25A-34-1	1	1.1/16"	310	58.4	41.6	23.3	29.5	10	14.6	7.2	382
25A-36-1	1	1.1/8"	330	60.4	45.6	23.3	32.1	10.6	15.6	7.6	476
25A-40-1	1	1.1/4"	349	67.4	48.8	25.3	35.6	11.2	17.8	8	567
25A-44-1	1	1.3/8"	350	67.4	48.8	25.3	35.6	11.2	17.8	8	541
25A-46-1	1	1.7/16"	401	74	54	31	62	10.4	17	8	787
25A-48-1	1	1.1/2"	401	74	54	31	62	10.4	17	8	787
25A-52-1	1	1.5/8"	435	80	61	34	70	11.5	19.5	8	1.050
25A-58-1	1	1.13/16"	555	91	66	34	79.8	15	23	11	1.850
25A-64-1	1	2"	602	100	73	36.6	86.7	17	26	12	2.215
25A-08-2	1	1/4"	103	15.9	10.6	6.6	7.9	3.7	5.2	3	15
25A-10-2	1	5/16"	119	19	13.6	7.2	9.9	4	6	3.3	21
25A-12-2	1	3/8"	124	21.2	15.1	8.3	10.4	4	6.8	3.4	26
25A-14-2	1	7/16"	143	26	17.1	9.5	12.6	4.8	7.5	3.6	39
25A-16-2	1	1/2"	164	30	20.2	11.9	14.6	5.2	8.3	4.2	63
25A-18-2	1	9/16"	174	30	21.2	11.8	15.8	5.8	8.9	4.6	68
25A-20-2	1	5/8"	194	35.3	23.8	13.6	17.6	6.3	9.5	5	107
25A-22-2	1	11/16"	214	39.4	26.8	14.8	20.5	6.7	10.5	5.2	137
25A-24-2	1	3/4"	228	41.6	28.3	16.2	21.1	7	11.2	5.2	163
25A-26-2	1	13/16"	249.5	45.4	32.4	17.3	22.8	8.6	12.6	6	210
25A-28-2	1	7/8"	249.5	45.4	32.4	17.3	22.8	8.6	12.6	6	210
25A-30-2	1	15/16"	270	49.7	36.1	20.3	25	9.2	13.6	6.4	281
25A-32-2	1	1"	289.5	53.4	39.6	22.5	27.6	9.6	14.2	6.8	346

COMBINATION WRENCH SET



- Material: High performance alloy steel, CrV
- Finish: Chrome-plated matt finished
- Hardness: 42-50 HRC
- Standards: DIN 3113, ISO 1711-1, ISO 3318, ISO 691, ISO 7738

IRIMO	Box	Box	Box	g
25-8-H	1	8	250 x 120 x 50	875
25-08-1, 25-10-1, 25-11-1, 25-13-1, 25-14-1, 25-17-1, 25-19-1, 25-22-1				

COMBINATION WRENCH SET



- Material: High performance alloy steel, CrV
- Finish: Chrome-plated matt finished
- Hardness: 42-50 HRC
- Standards: DIN 3113, ISO 1711-1, ISO 3318, ISO 691, ISO 7738

IRIMO	Box	Box	Box	g
25-12-H	1	12	350 x 50 x 70	2.975
25-10-1, 25-11-1, 25-12-1, 25-13-1, 25-14-1, 25-17-1, 25-19-1, 25-22-1, 25-24-1, 25-27-1, 25-30-1, 25-32-1				

COMBINATION WRENCH SET



- High performance alloy steel, CrV
- Finish: Chrome-plated matt finished
- Hardness: 42-50 HRc
- Standards: DIN 3113, ISO 1711-1, ISO 3318, ISO 691, ISO 7738

E	X	X	X	g
25-12-W	1	12	400 x 140 x 100	2.975
25-10-1, 25-11-1, 25-12-1, 25-13-1, 25-14-1, 25-17-1, 25-19-1, 25-22-1, 25-24-1, 25-27-1, 25-30-1, 25-32-1				

RATCHETING COMBINATION WRENCHES

RATCHETING COMBINATION WRENCH



- Material: High performance alloy steel
- Finish: Chrome-plated matt finished
- Hardness: 40-50 HRc

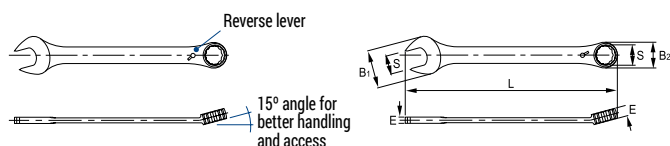

Strong ratchet exceeds ISO plus endurance

E	X	S mm	B1 mm	B2 mm	E mm	L mm	g
18-06-1	1	6	15	14.3	4	128	27
18-07-1	1	7	16.4	16.8	4.4	138	35
18-08-1	1	8	18	18.3	4.8	140	38
18-09-1	1	9	20	20	4.8	150	48
18-10-1	1	10	22	21.5	5.1	160	57
18-11-1	1	11	24.5	23.5	5.5	165	67
18-12-1	1	12	26	25	5.9	170	82
18-13-1	1	13	28	26.4	6.4	180	95
18-14-1	1	14	30.8	28	6.7	190	113
18-15-1	1	15	33	30	7.3	200	130
18-16-1	1	16	24.5	31	7.8	210	158
18-17-1	1	17	37	33	8	225	180
18-18-1	1	18	39.5	35	8.2	235	213
18-19-1	1	19	40.8	36	8.4	245	233
18-21-1	1	21	44.8	42	9	290	343
18-22-1	1	22	44.8	42	9	290	345
18-24-1	1	24	52.8	48	9.7	332	503
18-27-1	1	27	56	53	10.8	359	550
18-30-1	1	30	62	58	11.2	404	750
18-32-1	1	32	65	62	12	424	900

RATCHETING COMBINATION WRENCH SET



- Ratcheting combination wrench set
- Material: High performance alloy steel
- Finish: Chrome-plated matt finished
- Hardness: 40-50 HRc

E	X	X	X	g
18-8-H	1	8	45 x 245 x 130	870
18-08-1, 18-10-1, 18-11-1, 18-12-1, 18-13-1, 18-14-1, 18-17-1, 18-19-1				

RATCHETING COMBINATION WRENCHES

RATCHETING COMBINATION WRENCH SET



- Material: High performance alloy steel
- Finish: Chrome-plated matt finished
- Hardness: 40-50 HRc

Part No.	Qty	Qty per Case	Dimensions (mm)	Weight (g)
18-12-H	1	12	180 x 35 x 250	1.510
18-08-1, 18-09-1, 18-10-1, 18-11-1, 18-12-1, 18-13-1, 18-14-1, 18-15-1, 18-16-1, 18-17-1, 18-18-1, 18-19-1				

STUBBY RATCHETING COMBINATION WRENCHES

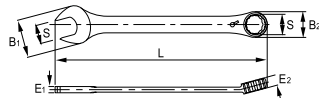

- Material: High performance alloy steel
- Finish: Chrome-plated matt finished
- Hardness: 40-50 HRc
- -1 retail packaging

Part No.	Qty	S (mm)	B1 (mm)	B2 (mm)	E1 (mm)	E2 (mm)	L (mm)	Weight (g)
18S-08-1	1	8	18	18.3	5.3	7.2	90	30
18S-10-1	1	10	22	22	6.0	7.8	96	48
18S-13-1	1	13	28	28	6.8	9.1	108	72
18S-17-1	1	17	37	37	8.1	10.5	128	125
18S-19-1	1	19	40.8	40.8	8.5	11.2	138	163

STUBBY RATCHETING COMBINATION WRENCH SET



- Material: High performance alloy steel
- Finish: Chrome-plated matt finished
- Hardness: 40-50 HRc

Part No.	Qty	Qty per Case	Dimensions (mm)	Weight (g)
18S-5-H	5	5	8-10-13-17-19 mm	462

RATCHETING DOUBLE RING WRENCH SET



- Material: High performance alloy steel
- Finish: Chrome-plated matt finished
- Hardness: 40-50 HRc

Part No.	Qty	Qty per Case	Dimensions (mm)	Weight (g)
18D-5-H	5	5	8x9, 10x11, 12x13, 16x17, 18x19 mm	664

FLEX HEAD RATCHETING COMBINATION WRENCHES

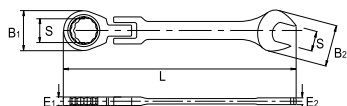

- Material: High performance alloy steel
- Finish: Chrome-plated
- Hardness: 40-50 HRC

Q	Icon	S mm	B1 mm	B2 mm	E1 mm	E2 mm	L mm	g
19-08-1	1	8	18.3	18	7.2	4.8	140	35
19-10-1	1	10	21.5	22	7.8	5.1	160	55
19-11-1	1	11	23.5	24.5	8.4	5.5	165	63
19-12-1	1	12	25	26	8.8	5.9	170	83
19-13-1	1	13	26.4	28	9.1	6.4	180	93
19-14-1	1	14	28	30.8	9.4	6.7	190	113
19-17-1	1	17	33	37	10.5	8	225	173
19-19-1	1	19	36.5	40.8	11.2	8.4	245	233

FLEX HEAD RATCHETING COMBINATION WRENCH SET



- Material: High performance alloy steel
- Finish: Chrome-plated matt finished
- Hardness: 40-50 HRC

Q	Icon	Icon	Icon	g
19-8-H	1	8	45 x 240 x 140	850

19-08-1, 19-10-1, 19-11-1, 19-12-1, 19-13-1, 19-14-1, 19-17-1, 19-19-1

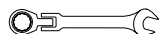

FLEX HEAD RATCHETING COMBINATION WRENCH SET



- Material: High performance alloy steel
- Finish: Chrome-plated matt finished
- Hardness: 40-50 HRC

Q	Icon	Icon	Icon	g
19-12-H	1	12	35 x 180 x 250	1.724

19-08-1, 19-09-1, 19-10-1, 19-11-1, 19-12-1, 19-13-1, 19-14-1, 19-15-1, 19-16-1, 19-17-1, 19-18-1, 19-19-1

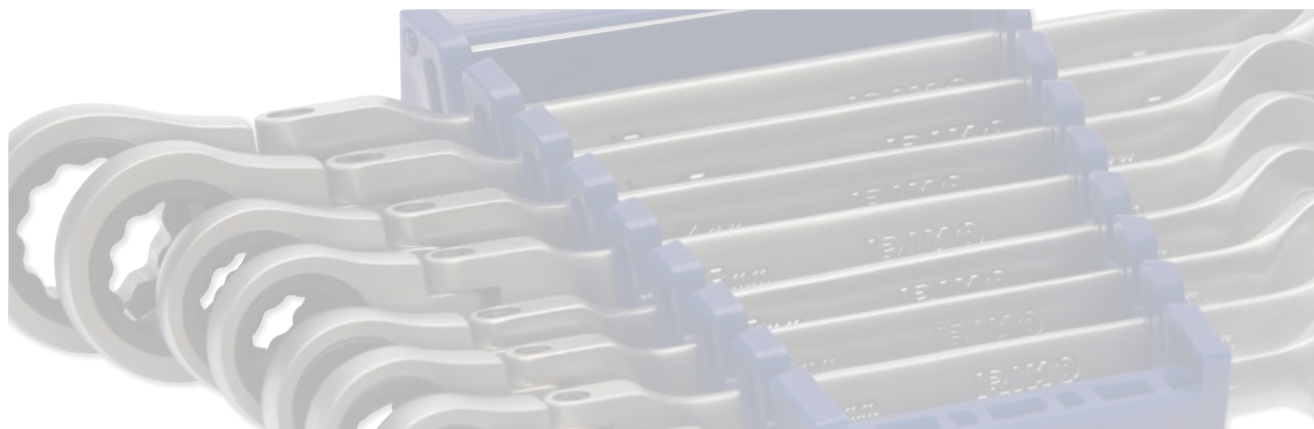
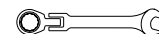

FLAT RING WRENCHES

DOUBLE RING END WRENCHES

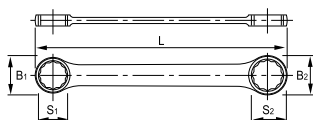

- Material: High performance alloy steel, CrV
- Finish: Chrome-plated matt finished
- Hardness: 42-48 HRC
- Standards: DIN 837, ISO 10103, ISO 1085

Q	Box	S1 x S2 mm	B1 mm	B2 mm	E mm	L mm	g
020011	1	6x7	9.8	11	4.5	95	14
020031	1	8x9	12.5	14	5.5	110	22
020051	1	10x11	15	16.5	6	125	32
020071	1	12x13	18.5	20	6.5	140	46
020091	1	14x15	21	22.5	7	155	57
020121	1	16x17	24	25	7.5	170	73
020141	1	18x19	26.5	27.5	8	185	94
020171	1	20x22	29	32	9	205	125
020181	1	21x23	30	33	9.5	225	154
020201	1	24x26	35	37.8	11	250	210
020211	1	24x27	35	37.5	11	250	208
020221	1	25x28	37.5	41	11	275	280
020241	1	27x29	37.5	41	11	275	272
020251	1	30x32	43	45.5	12	300	367

DOUBLE RING END WRENCHES SET



- Material: High performance alloy steel, CrV
- Finish: Chrome-plated matt finished
- Hardness: 42-48 HRC
- Standards: DIN 837, ISO 10103, ISO 1085

Q	Box	Case	Wrench	g
021221	1	8	6-7, 8-9, 10-11, 12-13, 14-15, 16-17, 18-19, 20-22 mm	500
021251	1	12	6-7, 8-9, 10-11, 12-13, 14-15, 16-17, 18-19, 20-22, 21-23, 24-27, 25-28, 30-32 mm	1.550

OFFSET RING WRENCHES

DOUBLE OFFSET RING WRENCHES

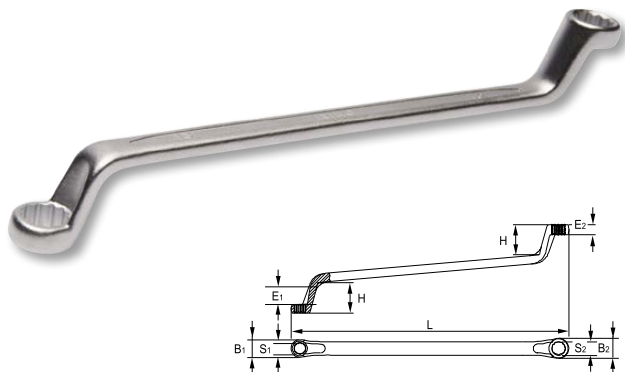

- Material: High performance alloy steel
- Finish: Chrome-plated matt finished
- Hardness: 42-48 HRC
- Standards: ISO 10104 and DIN 838
- -1 Retail packaging
- -2 Industrial packaging

E		S1 x S2 mm	B1 mm	B2 mm	E1 mm	E2 mm	H mm	L mm	g
15-0607-1	1	6x7	10.8	12.5	4.9	5.6	20	170	45
15-0809-1	1	8x9	13.4	15.3	6.0	6.8	21	182	70
15-1011-1	1	10x11	16.0	17.8	7.4	7.9	23	197	90
15-1213-1	1	12x13	18.8	20.2	8.4	8.9	25	213	126
15-1415-1	1	14x15	20.8	22.5	9.4	9.9	26	228	155
15-1617-1	1	16x17	24.2	25.7	10.4	10.9	29	246	193
15-1719-1	1	17x19	27.6	28.7	11.4	11.9	31	265	243
15-1819-1	1	18x19	27.6	28.7	11.4	11.9	31	265	241
15-2022-1	1	20x22	29.7	32.5	12.4	12.9	33	288	315
15-2123-1	1	21x23	31.0	33.2	12.3	13.3	33	310	341
15-2426-1	1	24x26	34.8	39.2	13.7	14.3	34	330	478
15-2427-1	1	24x27	34.8	39.2	13.7	14.3	34	330	475
15-2528-1	1	25x28	36.6	40.5	14.2	14.7	35	348	548
15-2729-1	1	27x29	42.0	45.2	15.0	16.0	37	372	662
15-3032-1	1	30x32	42.2	45.5	14.8	15.8	37	372	635
15-3236-2	1	32x36	48.5	54.0	16.5	17.8	41	417	962
15-3641-2	1	36x41	53.5	62.0	17.3	19.2	48	450	1.037

DOUBLE OFFSET RING WRENCHES SET



- Material: High performance alloy steel
- Finish: Chrome-plated matt finished
- Hardness: 42-48 HRC
- Standards: ISO 10104 and DIN 838

E				g
15-8-H	1	8	6-7, 8-9, 10-11, 12-13, 14-15, 16-17, 18-19, 20-22 mm	1.245

DOUBLE OFFSET RING WRENCHES SET



- Material: High performance alloy steel
- Finish: Chrome-plated matt finished
- Hardness: 42-48 HRC
- Standards: ISO 10104 and DIN 838

E				g
15-8-W	1	8	6-7, 8-9, 10-11, 12-13, 14-15, 16-17, 18-19, 20-22 mm	1.350
15-12-W	1	12	6-7, 8-9, 10-11, 12-13, 14-15, 16-17, 18-19, 20-22, 21-23, 24-27, 25-28, 30-32 mm	3.465



L-PIPE DOUBLE SOCKET WRENCHES

L-PIPE DOUBLE SOCKET WRENCHES

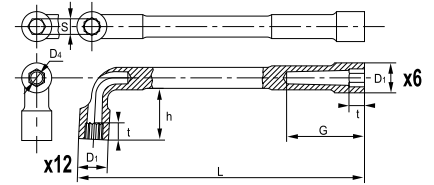
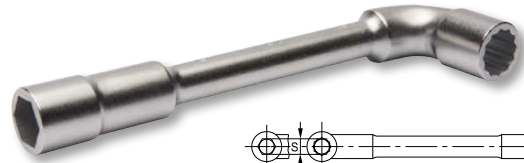

- Material: High performance alloy steel
- Finish: Chrome-plated matt finished
- Hardness: 40-50 HRC
- Standards: ISO 1711, ISO 691, ISO 2236

6x12	6x6	S		D1 mm	D4 mm	G mm	h mm	t mm	L mm	g
51-06-1	52-06-1	6	1	10	4.5	21.0	17	6.0	102	30
51-07-1	52-07-1	7	1	11	4.5	22.0	17.5	7.0	106	40
51-08-1	52-08-1	8	1	12.5	7.0	25.0	19.5	8.0	114	60
51-09-1	52-09-1	9	1	13.5	7.0	26.0	20.0	9.0	122	70
51-10-1	52-10-1	10	1	15.0	8.0	28.0	24.0	10.0	129	90
51-11-1	52-11-1	11	1	16.5	8.0	30.0	26.5	11.0	136	120
51-12-1	52-12-1	12	1	18.0	9.0	36.0	28.0	11.0	144	150
51-13-1	52-13-1	13	1	19.5	9.0	38.6	30.0	12.0	152	160
51-14-1	52-14-1	14	1	21.0	10.5	40.0	31.5	13.0	160	190
51-15-1	52-15-1	15	1	22.5	10.5	42.0	34.0	14.0	169	200
51-16-1	52-16-1	16	1	24.0	13.0	46.0	37.0	16.0	178	280
51-17-1	52-17-1	17	1	25.5	13.0	48.0	39.0	17.0	187	300
51-18-1	52-18-1	18	1	26.5	13.0	50.0	40.0	18.0	195	310
51-19-1	52-19-1	19	1	28.5	15.0	51.0	41.0	19.0	204	420
51-20-1	52-20-1	20	1	29.5	15.0	53.0	43.0	20.0	212	450
51-21-1	52-21-1	21	1	30.5	15.0	55.0	46.0	21.0	221	470
51-22-1	52-22-1	22	1	32.0	15.0	57.0	48.0	22.0	230	530
51-23-1	52-23-1	23	1	33.5	18.0	64.0	50.5	23.0	240	650
51-24-1	52-24-1	24	1	34.5	18.0	67.0	54.0	24.0	250	630
51-25-1	52-25-1	25	1	36.0	20.0	69.0	56.0	25.0	260	830
51-26-1	52-26-1	26	1	37.0	20.0	70.0	58.5	26.0	270	860
51-27-1	52-27-1	27	1	38.0	22.0	73.0	58.0	27.0	280	990
51-28-1	52-28-1	28	1	39.5	22.0	75.0	60.0	28.0	290	1.000
51-29-1	52-29-1	29	1	41.0	22.0	76.0	62.0	29.0	300	1.080
51-30-1	52-30-1	30	1	42.0	24.0	83.0	64.0	30.0	310	1.220
51-32-1	52-32-1	32	1	44.5	24.0	88.0	70.0	31.0	330	1.380

L-PIPE DOUBLE SOCKET WRENCHES SET



- Material: High performance alloy steel
- Finish: Chrome-plated matt finished
- Hardness: 40-50 HRC
- Standards: ISO 1711, ISO 691, ISO 2236

6x12				g
51-8-W	1	8	8, 10, 11, 13, 14, 17, 19, 22 mm	1.980
6x6				g
52-8-W	1	8	8, 10, 11, 13, 14, 17, 19, 22 mm	1.980

TUBULAR SOLID WRENCHES

DOUBLE HEAD SOCKET WRENCHES

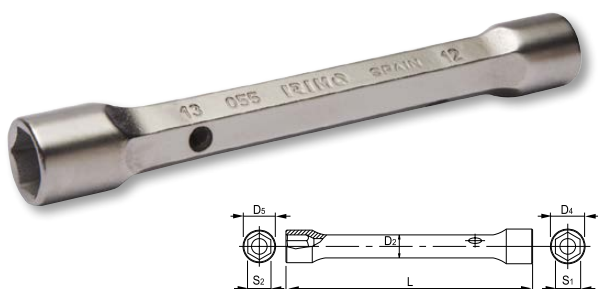

- Material: High performance alloy steel, CrV
- Finish: Chrome-plated matt finished
- From 16 onwards, with hole to locate the stud
- Hardness: 42-48 HRc
- Standards: UNE 16586

IRIMO	Box	S1x S2 mm	D4 mm	D5 mm	D2 mm	L mm	g
055011	10	6x7	10	11	7	103	31
055031	10	8x9	12.5	13.5	9	108	53
055051	10	10x11	15	16	11	120	78
055071	10	12x13	17	19	13	138	127
055091	10	14x15	20	21	14	143	152
055121	10	16x17	22	24	16	153	185
055141	10	18x19	25	26	18	163	235
055171	10	20x22	28	30	20	173	312
055181	5	21x23	29	31	21	183	359
055201	5	24x26	33	35	24	193	438
055211	5	24x27	33	37	24	193	466
055221	5	25x28	34	37	25	203	535
055241	5	27x29	37	39	27	208	592
055251	5	30x32	40	43	30	208	737

DOUBLE HEAD SOCKET WRENCHES SET



- Material: High performance alloy steel, CrV
- Finish: Chrome-plated matt finished
- From 16 onwards, with hole to locate the stud
- Hardness: 42-48 HRc
- Standards: UNE 16586

IRIMO	Box	Box	Diagram	g
056231	1	8	6-7, 8-9, 10-11, 12-13, 14-15, 16-17, 18-19, 20-22 mm	1.150
056271	1	12	6-7, 8-9, 10-11, 12-13, 14-15, 16-17, 18-19, 20-22, 21-23, 24-26, 25-28, 30-32 mm	3.200

BAR HANDLE FOR SOCKET WRENCH

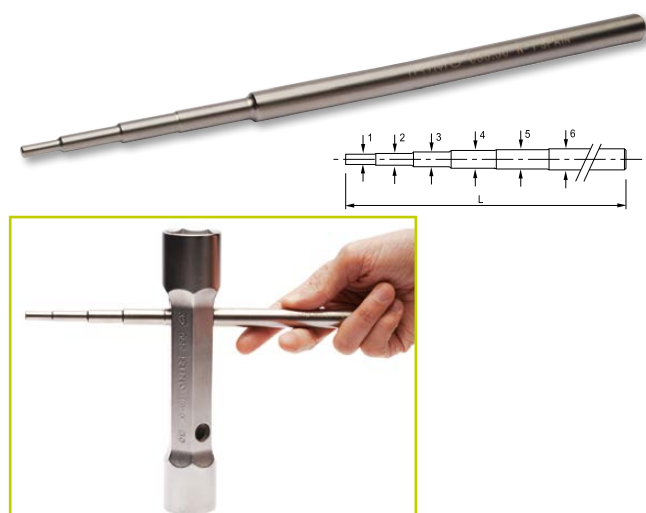

- Material: High performance alloy steel, CrV
- Hardness: 42-48 HRc
- Standards: DIN 900

IRIMO	Box	Diagram	L mm	g
055301	1	3.1 4.3 5.3 5.8 8 - 6x7	14x15	175 54
055311	1	6.8 7.8 9.8 11.8 12.8 14 16x17	30x32	270 251

SLOGGING RING, OPEN END

RING END SLOGGING WRENCHES

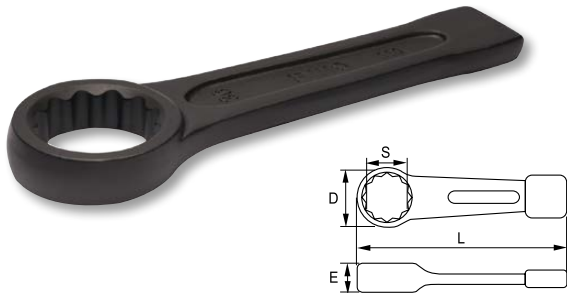

- Material: High performance alloy steel
- Hardness: 24-46 mm - 34-40 HRc and 50-120 mm - 30-36 HRc
- Standards: DIN 7444

R	Box	S mm	D mm	E mm	L mm	g
30-24-2	1	24	43	15	165	235
30-27-2	1	27	46	16	180	290
30-30-2	1	30	53	18	195	435
30-32-2	1	32	53	18	195	415
30-34-2	1	34	59	18	205	510
30-36-2	1	36	59	18	205	510
30-38-2	1	38	59	18	205	510
30-41-2	1	41	65	20	230	710
30-46-2	1	46	74	22.5	240	980
30-50-2	1	50	79	24	255	1.050
30-55-2	1	55	86	25	270	1.410
30-60-2	1	60	93	26	280	1.640
30-65-2	1	65	103	29	300	2.180
30-70-2	1	70	109	33	315	2.400
30-75-2	1	75	114	34	330	2.775
30-80-2	1	80	125	36	348	3.150
30-85-2	1	85	129	37	360	4.860
30-90-2	1	90	148	40	379	5.680
30-95-2	1	95	151	41	395	6.500
30-100-2	1	100	154	45	405	7.830

OPEN END SLOGGING WRENCHES

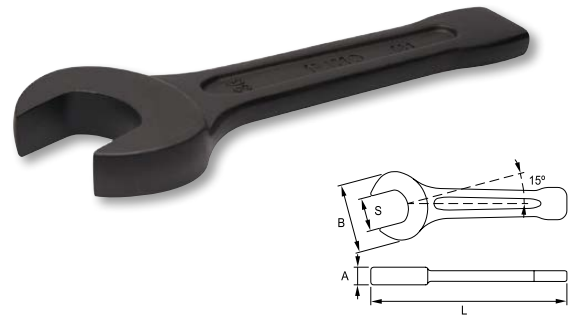

- Material: High performance alloy steel
- Hardness: 24-46 mm - 34-40 HRc and 50-120 mm - 30-36 HRc
- Standards: DIN 133

R	Box	S mm	A mm	B mm	L mm	g
31-30-2	1	30	17	65	190	550
31-32-2	1	32	17	67	195	560
31-36-2	1	36	18	77	210	845
31-41-2	1	41	19	88	230	1.040
31-46-2	1	46	20	96	250	1.375
31-50-2	1	50	21	106	275	1.670
31-55-2	1	55	24	116	305	2.175
31-60-2	1	60	24	125	315	2.455
31-65-2	1	65	28	136	345	3.550
31-70-2	1	70	30	148	370	4.075
31-75-2	1	75	30	158	385	5.170
31-80-2	1	80	33	170	400	5.785
31-85-2	1	85	33	174	410	6.870

HOOK WRENCHES

HOOK WRENCH

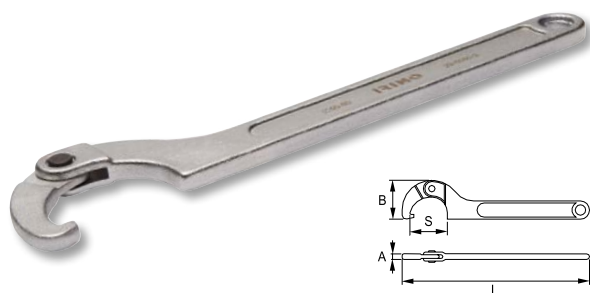

- Material: High performance alloy steel
- Finish: Chrome-plated matt finished
- Hardness: 40 HRc
- Standards: DIN 137-B

Q	📦	S mm	A mm	B mm	L mm	g
29-3550-2	1	35-50	6	38	202	186
29-5080-2	1	50-80	8	55	280	382
29-80120-2	1	80-120	9	75	345	642

HOOK WRENCH WITH INTERCHANGEABLE PIN

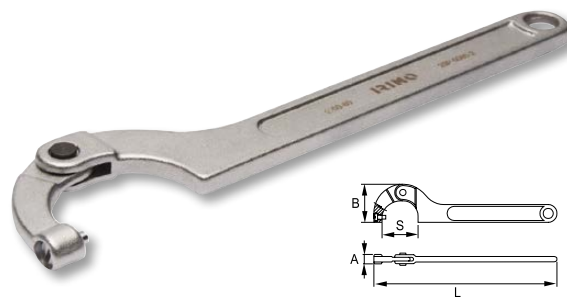

- Material: High performance alloy steel
- Finish: Chrome-plated matt finished
- Hardness: 40 HRc
- Standards: DIN 137-B

Q	📦	S mm	A mm	B mm	L mm	g
29P-3550-2	1	35-50	11	38	202	186
29P-5080-2	1	50-80	14	55	280	382
29P-80120-2	1	80-120	18	75	345	642

SPARE PART - INTERCHANGEABLE PIN



- Material: High performance alloy steel

Q	📦	🔧	D mm	g
29P-3550-A	1	29P-3550-2	4	5
29P-5080-A	1	29P-5080-2	5	9
29P-80120-A	1	29P-80120-2	6	19

MULTIFITTING KEY

7 IN 1 UNIVERSAL KEY



- Universal key for all common locks
- 1 wrench for 7 different applications
- With radiator aerating key in the central hub
- For electricity, heating, ventilation and air-conditioning systems as well as building construction applications
- Made from zinc die casting, with chain, adaptor and bit (1,2x7 mm & PH2)
- Plastic blister retail packaging

Q	📦	⊙	⊕	□	▲	⊖	L mm	g
71-UN7-1	1	1.2	PH-2	3-5	9	3-5	72x72	89

9 IN 1 UNIVERSAL KEY



- Universal key for all common locks
- 1 wrench for 9 different applications
- For electricity, heating, ventilation and air-conditioning systems as well as building construction applications
- Made from zinc die casting, with chain, adaptor and bit (1,2x7 mm & PH2)
- Plastic blister retail packaging

Q	📦	⊙	⊕	□	▲	■	L mm	g
71-UN9-1	1	1.2	PH-2	5-7-8	9-10	9-10	90x62	87



03. TORQUE TOOLS

TORQUE WRENCHES

ADJUSTABLE CLICK WRENCH WITH FIXED RATCHET HEADS

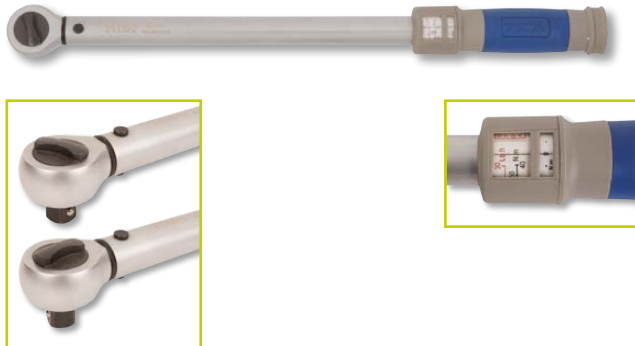

- Adjustable mechanical clock torque wrench
- Precision: ± 4% clockwise
- Fixed ratchet head
- Reversible ratchet with 45 teeth / 8° angle action
- Plastic handle for higher comfort
- Standard: ISO 6789

R	Box	Size	Nm	Δ Nm	L mm	kg
070411	1	1/4"	4-20	0.050	275	0.5
070421	1	3/8"	10-60	0.125	360	0.8
070431	1	1/2"	25-125	0.25	420	0.9
070441	1	1/2"	40-200	0.5	460	1.0
070451	1	1/2"	65-335	0.5	520	1.2
070461	1	3/4"	65-335	0.5	520	1.2
070471	1	3/4"	150-800	2	1.040	4.9
070481	1	1"	300-1500	3	1.250	8.2

ADJUSTABLE CLICK WRENCH WITH INTERCHANGEABLE HEADS

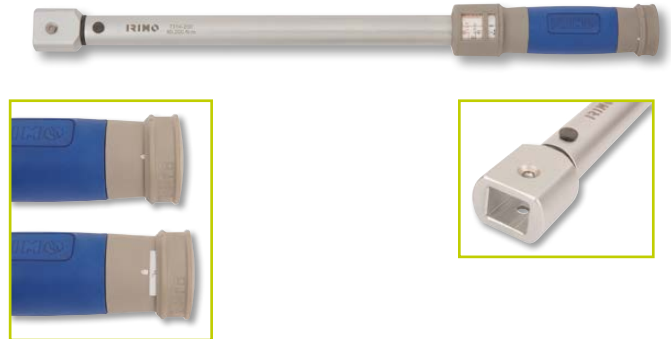

- Adjustable mechanical click torque wrenches
- Precision: ± 4%
- 9x12 and 14x18 interchangeable heads
- Plastic handle for higher comfort
- Standard: ISO 6789

R	Box	Head	Nm	Δ Nm	L mm	kg
7309-30	1	9x12	6-30	0.050	298	0.6
7309-60	1	9x12	10-60	0.125	367	0.7
7309-125	1	9x12	25-125	0.25	422	0.8
7314-200	1	14x18	40-200	0.5	455	0.9
7314-335	1	14x18	65-335	0.5	515	1.1

9x12 MM OPEN END INSERTS

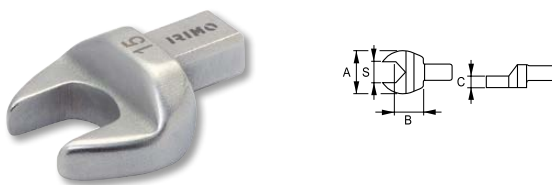

- Open-end insert heads, 9x12 mm
- High performance alloy steel
- Forged chrome-plated

R	Box	S mm	A mm	B mm	C mm	g
7309-1-10	1	10	25	17.5	5.7	40
7309-1-11	1	11	26	17.5	5.7	40
7309-1-12	1	12	28	17.5	5.7	45
7309-1-13	1	13	29	17.5	5.7	45
7309-1-14	1	14	32	20.0	7.7	50
7309-1-17	1	17	38	20.0	7.7	60
7309-1-19	1	19	42	20.0	7.7	70

9x12 MM RING END INSERTS

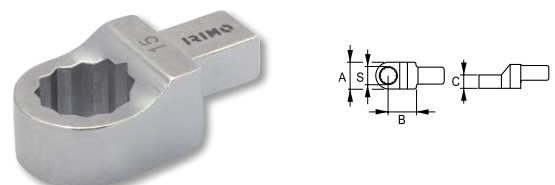

- Ring-end insert head, 9x12 mm
- High performance alloy steel
- Forged chrome-plated

R	Box	S mm	A mm	B mm	C mm	g
7309-2-10	1	10	18	17.5	8	40
7309-2-11	1	11	19	17.5	8	40
7309-2-12	1	12	20	17.5	12	50
7309-2-13	1	13	21	17.5	12	50
7309-2-14	1	14	23	17.5	12	50
7309-2-17	1	17	27	17.5	13	50
7309-2-19	1	19	31	17.5	13	60
7309-2-22	1	22	35	17.5	15	80

9x12 & 14x18 MM RATCHET HEAD INSERTS

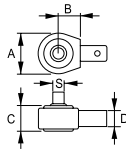

- 1/4", 3/8" & 1/2" square drive ratchet inserts in 9x12 mm
- 1/2" Square drive ratchet inserts in 14x18 mm
- Teeth number: 45
- Angle action: 8°
- High performance alloy steel
- Forged chrome-plated

E	Icon	S mm	A mm	B mm	C mm	D mm	Max Nm	g
7309-1/4	1	1/4"	37	18	20	9x12	25	135
7309-3/8	1	3/8"	38	18	20	9x12	160	160
7309-1/2	1	1/2"	38	18	20	9x12	160	160
7314-1/2	1	1/2"	40	25	20	14x18	420	265

14x18 MM OPEN END INSERTS

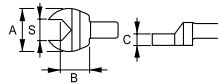

- Open-end insert head, 14x18 mm
- High performance alloy steel
- Forged chrome-plated

E	Icon	S mm	A mm	B mm	C mm	g
7314-1-13	1	13	30	25.0	7	130
7314-1-14	1	14	31	25.0	7	130
7314-1-17	1	17	37	25.0	9	135
7314-1-19	1	19	41	25.0	9	140
7314-1-22	1	22	47	25.0	11	170
7314-1-24	1	24	51	25.0	11	180
7314-1-27	1	27	59	32.5	14	220
7314-1-30	1	30	63	32.5	14	240
7314-1-32	1	32	65	32.5	14	240

14x18 MM RING END INSERTS

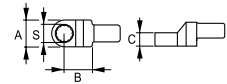

- Ring-end insert head, 14x18 mm
- High performance alloy steel
- Forged chrome-plated

E	Icon	S mm	A mm	B mm	C mm	g
7314-2-13	1	13	21	25	12	120
7314-2-14	1	14	23	25	12	120
7314-2-17	1	17	28	25	13	130
7314-2-19	1	19	30	25	13	140
7314-2-22	1	22	35	25	15	145
7314-2-24	1	24	38	25	15	145
7314-2-27	1	27	42	31	18	170
7314-2-30	1	30	45	31	18	180
7314-2-32	1	32	48	31	18	180
7314-2-36	1	36	53	31	19	205
7314-2-41	1	41	59	31	19	235

1



2



3



4



5



6



7



8



9



10





11



12



BOLTS AND NUTS. PRE-LOAD AND TORQUE DATA

	coarse pitch			resistant area	friction coefficient	PROPERTY CLASS. COARSE PITCH											
						4.8		5.8		6.8		8.8		10.9		12.9	
						Pre-load N	Torque Nm	Pre-load N	Torque Nm	Pre-load N	Torque Nm	Pre-load N	Torque Nm	Pre-load N	Torque Nm	Pre-load N	Torque Nm
M2	040	40	15	207	0.10 0.14	4480 4495	0.15 0.19	610.6 561.9	0.19 0.23	732.7 674.3	0.23 0.28	976.9 899.0	0.31 0.37	1373.8 1264.3	0.43 0.52	1648.6 1517.1	0.52 0.63
M2.5	045	50	20	3.39	0.10 0.14	813.5 749.9	0.31 0.38	1016.9 937.4	0.39 0.48	1220.2 1124.9	0.47 0.58	1627.0 1499.8	0.63 0.77	2288.0 2109.1	0.88 1.08	2745.6 2531.0	1.06 1.30
M3	050	55	25	5.03	0.10 0.14	1219.9 1125.9	0.54 0.60	1524.9 1407.4	0.68 0.83	1829.9 1688.9	0.82 1.00	2439.9 2251.9	1.09 1.34	3431.0 3166.7	1.53 1.88	4117.2 3800.0	1.84 2.26
M3.5	060	60	-	6.78	0.10 0.14	1638.2 1511.3	0.84 1.03	2047.8 1889.2	1.05 1.28	2457.3 2267.0	1.26 1.54	3276.4 3022.6	1.68 2.05	4607.5 4250.6	2.36 2.89	5528.9 5100.7	2.84 3.47
M4	070	70	30	8.78	0.10 0.14	2115.4 1950.9	1.25 1.53	2644.3 2438.7	1.56 1.91	3173.1 2926.4	1.88 2.29	4230.8 3901.9	2.50 3.06	5949.6 5487.0	3.52 4.30	7139.5 6584.4	4.22 5.16
M5	080	80	40	14.20	0.10 0.14	3461.6 3196.8	2.46 3.02	4327.0 3996.0	3.08 3.78	5192.3 4795.2	3.70 4.53	6923.1 6393.7	4.93 6.04	9735.7 8991.1	6.93 8.50	11682.8 10789.3	8.32 10.20
M6	100	100	50	20.10	0.10 0.14	4874.7 4499.1	4.24 5.19	6093.4 5623.9	5.30 6.48	7312.1 6748.6	6.35 7.78	9749.4 8998.2	8.47 10.37	13710.1 12653.7	11.92 14.59	16452.2 15184.4	14.30 17.51
M7	100	110	-	28.90	0.10 0.14	7134.5 6599.6	6.97 8.60	8918.2 8249.5	8.71 10.76	10701.8 9899.4	10.45 12.90	14269.1 13199.2	13.94 17.21	20065.9 18561.4	19.60 24.20	24079.1 22273.6	23.52 29.04
M8	125	130	60	36.60	0.10 0.14	8947.1 8265.6	10.20 12.54	11183.9 10332.0	12.75 15.67	13420.7 12398.4	15.30 18.80	17894.2 16531.2	20.41 25.07	25163.7 23247.0	28.70 35.26	30196.5 27896.5	34.44 42.31
M10	150	160	80	58.00	0.10 0.14	14244.5 13167.4	20.11 24.76	17805.6 16459.2	25.14 30.95	21366.8 19751.1	30.16 37.14	28489.0 26334.8	40.22 49.52	40062.7 37033.3	56.56 69.64	48075.3 44439.9	67.87 83.56
M12	175	180	100	84.30	0.10 0.14	20766.6 19204.0	34.43 42.42	25958.3 24005.0	43.03 53.03	31149.9 28806.0	51.64 63.63	41533.2 38408.0	68.86 84.84	58406.1 54011.2	96.83 119.31	70087.3 64813.5	116.20 143.17
M14	200	210	120	115.00	0.10 0.14	28389.9 26261.2	54.77 67.56	35487.4 32826.5	68.46 84.45	42584.9 39391.8	82.15 101.34	56779.8 52522.4	109.53 135.13	79846.6 73859.6	154.03 190.02	95816.0 88631.5	184.84 228.03
M16	200	240	140	157.00	0.10 0.14	39242.1 36364.2	85.14 105.80	49052.7 45455.3	106.43 132.26	58863.2 54546.3	127.72 158.71	78484.3 72728.5	170.29 211.61	110368.5 102274.4	239.47 297.58	132442.2 122729.3	287.36 357.09
M18	250	270	140	192.00	0.10 0.14	47533.0 43986.1	117.48 145.16	59416.3 54982.7	146.85 181.45	71299.6 65979.2	176.22 217.74	95066.1 87972.3	234.96 290.32	133686.7 123711.0	330.41 402.26	160424.1 148453.2	396.49 489.92
M20	250	300	170	245.00	0.10 0.14	61238.0 56747.1	166.08 206.39	76547.5 70933.9	207.61 257.98	91857.0 85120.6	249.13 309.58	122476.0 113494.2	332.17 412.78	172231.9 159601.2	467.11 580.47	206678.2 191521.5	560.54 696.56
M22	250	340	170	303.00	0.10 0.14	76305.2 70791.9	227.22 283.79	95381.5 88489.8	284.02 354.74	114457.8 106187.8	340.82 425.69	152610.4 141583.7	454.43 567.58	214608.3 199102.1	639.05 798.16	257530.0 238922.5	766.85 957.80
M24	300	360	190	353.00	0.10 0.14	88232.4 81761.8	287.16 356.84	110290.5 102202.2	358.94 446.05	132348.6 122642.7	430.73 535.26	176646.9 163523.6	574.31 713.68	248153.7 229955.5	807.63 1003.61	297784.4 275941.5	969.15 1204.33
M27	300	410	190	459.00	0.10 0.14	115778.8 107441.5	420.04 525.08	144723.5 134301.9	525.05 656.35	173668.2 161162.2	630.06 787.62	231557.6 214883.0	840.08 1050.16	325627.9 302179.2	1181.36 1476.79	390753.4 362615.0	1417.63 1772.15
M30	350	460	220	561.00	0.10 0.14	140999.5 130770.6	572.83 714.49	176249.4 163463.3	716.03 893.11	211499.3 196155.9	859.24 1071.73	281999.0 261541.2	1145.65 1428.97	396561.1 367792.3	1611.08 2009.49	475873.4 441350.8	1933.29 2411.39
M33	350	500	220	694.00	0.10 0.14	175618.1 163058.0	774.65 970.43	219522.6 203822.5	968.32 1213.03	263427.1 245587.0	1161.98 1455.64	351236.2 326115.9	1549.31 1940.86	493925.8 458600.5	2178.72 2729.33	592711.0 550320.6	2614.46 3275.19
M36	400	550	240	817.00	0.10 0.14	206081.7 191241.8	998.60 1248.41	257602.2 239052.3	1248.25 1560.51	309122.6 286862.7	1497.89 1872.61	412163.5 382483.6	1997.19 2496.81	579604.8 537867.6	2808.55 3511.14	695525.8 645441.1	3370.26 4213.37
M39	400	600	270	976.00	0.10 0.14	247520.0 229902.6	1291.81 1620.96	309400.0 287378.3	1614.77 2026.20	371279.9 344853.9	1937.72 2431.44	495039.9 459805.2	2583.63 3241.92	696149.8 646601.0	3633.23 4558.96	835379.8 775921.3	4359.88 5470.75
M42	450	650	-	1120.00	0.10 0.14	283225.0 262939.0	1601.25 2005.46	354031.2 328673.8	2001.57 2506.83	424837.4 394408.5	2401.88 3008.20	566449.9 525878.0	3202.51 4010.93	796570.1 739516.0	4503.53 5640.37	955884.2 887419.2	5404.23 6768.44
M45	450	700	320	1310.00	0.10 0.14	332751.5 309151.8	2005.51 2519.55	415939.4 386439.7	2506.89 3149.43	499127.3 463727.7	3008.26 3779.32	665503.0 618303.6	4011.02 5039.09	935863.6 869489.3	5640.50 7086.23	1123036.0 1043387.0	6768.60 8503.47
M48	500	750	-	1470.00	0.10 0.14	372429.3 345862.9	2406.51 3018.11	465536.6 432328.7	3008.14 3772.64	558644.0 518794.4	3609.77 4527.17	744858.6 691725.8	4813.03 6036.23	1047457.0 972739.4	6768.32 8488.45	1256949.0 1167287.0	8121.98 10186.14
M52	500	800	360	1760.00	0.10 0.14	448108.9 416499.0	3099.96 3900.52	560136.1 520623.8	3874.95 4875.65	672163.4 624748.5	4649.93 5850.78	896217.8 832998.0	6199.91 7801.04	1260306.0 1171404.0	8718.63 10970.21	1512368.0 1405684.0	10462.36 13164.25
M56	550	850	410	2030.00	0.10 0.14	516202.9 479683.4	3838.14 4824.40	645253.6 599604.2	4797.68 6030.50	774304.4 719525.1	5757.21 7236.60	1032406.0 959366.8	7676.29 9648.80	1451821.0 1349110.0	10794.78 13568.63	1742185.0 1618931.0	12953.73 16282.36
M60	550	900	-	2360.00	0.10 0.14	602498.5 560267.5	4754.64 5992.71	753123.1 700334.4	5943.30 7490.88	903747.8 840401.2	7131.96 8989.06	1204997.0 1120535.0	9509.28 11985.42	1694527.0 1575752.0	13372.43 16854.49	2033432.0 1890903.0	16046.91 20225.39
M64	600	950	460	2680.00	0.10 0.14	683339.5 635299.9	5746.17 7235.13	854174.4 794124.9	7182.71 9043.92	1025009.0 952949.8	8619.25 10852.70	1366679.0 1270600.0	11492.34 14470.27	1921892.0 1786781.0	16161.10 20348.82	2306271.0 2144137.0	19393.32 24418.58
M68	600	1000	-	3060.00	0.10 0.14	782799.9 728201.8	6939.64 8758.24	978499.8 910252.2	8674.55 10947.80	1174200.0 1092303.0	10409.46 13137.36	1565600.0 1456404.0	13879.28 17516.48	2201625.0 2048068.0	19517.74 24632.55	2641950.0 2457681.0	23421.29 29559.06



04. SOCKETRY

1/4" SOCKETS

1/4" HEXAGONAL SOCKETS

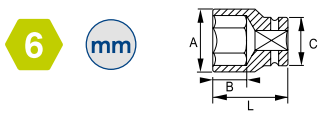

- Chrome vanadium alloy steel
- Chrome-plated bright finish
- Wave shape profile NPP
- Standards: DIN 3120, DIN 3124

R	Profile	Hex	A mm	B mm	C mm	L mm	g
101-04-1	5	4	6.9	9.0	12.0	25.0	11
101-045-1	5	4.5	7.5	9.0	12.0	25.0	11
101-05-1	5	5	8.2	9.0	12.0	25.0	11
101-055-1	5	5.5	8.8	9.0	12.0	25.0	12
101-06-1	5	6	9.4	9.0	12.0	25.0	11
101-07-1	5	7	11.0	9.0	12.0	25.0	13
101-08-1	5	8	12.0	12.0	12.0	25.0	13
101-09-1	5	9	13.0	12.0	13.0	25.0	15
101-10-1	5	10	14.0	12.0	12.6	25.0	21
101-11-1	5	11	16.0	12.0	14.0	25.0	24
101-12-1	5	12	17.0	12.0	14.8	25.0	26
101-13-1	5	13	18.0	12.0	15.8	25.0	28
101-14-1	5	14	20.0	12.0	17.4	25.0	39



R	Profile	Hex	A mm	B mm	C mm	L mm	g
101A-05-1	5	5/32"	6.9	8.5	12.0	25.0	10
101A-06-1	5	3/16"	7.5	8.5	12.0	25.0	10
101A-07-1	5	7/32"	8.8	9.5	12.0	25.0	11
101A-08-1	5	1/4"	9.4	9.5	12.0	25.0	11
101A-09-1	5	9/32"	11.0	10.5	12.0	25.0	13
101A-10-1	5	5/16"	12.0	10.5	12.0	25.0	12
101A-11-1	5	11/32"	13.0	10.5	12.0	25.0	14
101A-12-1	5	3/8"	14.0	10.5	12.6	25.0	18
101A-14-1	5	7/16"	16.0	11.5	14.0	25.0	23
101A-16-1	5	1/2"	18.0	11.5	15.8	25.0	29
101A-18-1	5	9/16"	20.0	11.5	17.4	25.0	37

1/4" DEEP HEXAGONAL SOCKETS

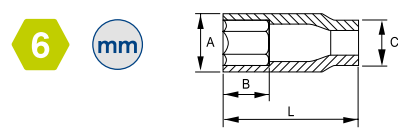

- Chrome vanadium alloy steel
- Chrome-plated bright finish
- Wave shape profile NPP
- Standards: DIN 3120, DIN 3124

R	Profile	Hex	A mm	B mm	C mm	L mm	g
103-04-1	5	4	6.9	12.0	12.0	50.0	21
103-045-1	5	4.5	7.5	12.0	12.0	50.0	20
103-05-1	5	5	8.2	12.0	12.0	50.0	21
103-055-1	5	5.5	8.8	12.0	12.0	50.0	22
103-06-1	5	6	9.4	12.0	12.0	50.0	22
103-07-1	5	7	11.0	24.0	12.0	50.0	26
103-08-1	5	8	12.0	24.0	10.9	50.0	29
103-09-1	5	9	13.0	24.0	11.6	50.0	30
103-10-1	5	10	14.0	24.0	13.0	50.0	39
103-11-1	5	11	16.0	24.0	14.2	50.0	44
103-12-1	5	12	17.0	24.0	15.0	50.0	49
103-13-1	5	13	18.0	24.0	16.0	50.0	55
103-14-1	5	14	20.0	24.0	17.0	50.0	65



R	Profile	Hex	A mm	B mm	C mm	L mm	g
103A-06-1	5	3/16"	8.2	12.0	12.0	50.0	21
103A-08-1	5	1/4"	9.7	12.0	12.0	50.0	22
103A-09-1	5	9/32"	11.2	24.0	12.0	50.0	26
103A-10-1	5	5/16"	12.0	24.0	12.0	50.0	29
103A-11-1	5	11/32"	13.0	24.0	12.0	50.0	30
103A-12-1	5	3/8"	13.7	24.0	12.0	50.0	39
103A-14-1	5	7/16"	16.1	24.0	14.2	50.0	44
103A-16-1	5	1/2"	18.0	24.0	16.0	50.0	55

1/4" SOCKETS, TORX®

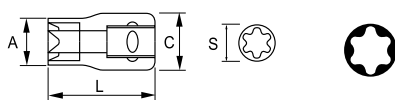

- Chrome vanadium alloy steel
- Chrome-plated bright finish
- Standard: DIN 3120

R	Profile	Hex	S mm	A mm	B mm	L mm	g
106-04-1	5	E-4	3.8	6.0	12.0	25.0	10
106-05-1	5	E-5	4.7	7.0	12.0	25.0	11
106-06-1	5	E-6	5.7	8.0	12.0	25.0	11
106-07-1	5	E-7	6.2	8.6	12.0	25.0	11
106-08-1	5	E-8	7.5	10.3	12.0	25.0	12
106-10-1	5	E-10	9.4	12.3	13.0	25.0	21

1/4" BIT DRIVERS

1/4" BIT DRIVER, SLOTTED



- Bit made with S2 special steel
- Slotted
- Standard: DIN 3120

R	Box	Ⓢ	A mm	B mm	L mm	g
107-0840-1	5	0.8 x 4	11.8	20.0	37.5	15
107-1055-1	5	1 x 5.5	11.8	20.0	37.5	15
107-1280-1	5	1.2 x 8	11.8	20.0	37.5	16

1/4" BIT DRIVER, PHILLIPS



- Bit made with S2 special steel
- Phillips bit driver
- Standard: DIN 3120

R	Box	Ⓢ	A mm	B mm	L mm	g
107-PH1-1	5	PH-1	11.8	20.0	37.5	15
107-PH2-1	5	PH-2	11.8	20.0	37.5	15
107-PH3-1	5	PH-3	11.8	20.0	37.5	16

1/4" BIT DRIVER, POZIDRIV



- Bit made with S2 special steel
- Pozidriv bit driver
- Standard: DIN 3120

R	Box	Ⓢ	A mm	B mm	L mm	g
107-PZ1-1	5	PZ-1	11.8	20.0	37.5	15
107-PZ2-1	5	PZ-2	11.8	20.0	37.5	15
107-PZ3-1	5	PZ-3	11.8	20.0	37.5	16

1/4" BIT DRIVER, HEXAGONAL



- Bit made with S2 special steel
- Hexagonal bit driver
- Standard: DIN 3120

R	Box	Ⓢ	A mm	B mm	L mm	g
107-H3-1	5	3	11.8	20.0	37.5	15
107-H4-1	5	4	11.8	20.0	37.5	15
107-H5-1	5	5	11.8	20.0	37.5	16
107-H6-1	5	6	11.8	20.0	37.5	17
107-H8-1	5	8	11.8	20.0	37.5	19

R	Box	Ⓢ	A mm	B mm	L mm	g
107A-4-1	5	1/8"	11.8	20.0	37.5	15
107A-5-1	5	5/32"	11.8	20.0	37.5	15
107A-6-1	5	3/16"	11.8	20.0	37.5	16
107A-7-1	5	7/32"	11.8	20.0	37.5	17

1/4" BIT DRIVER, TORX®



- Bit made with S2 special steel
- TORX® bit driver
- Standard: DIN 3120

R	Box	Ⓢ	S mm	A mm	C mm	L mm	g
107-T08-1	5	T8	2.3	11.8	20.0	37.5	15
107-T09-1	5	T9	2.5	11.8	20.0	37.5	15
107-T10-1	5	T10	2.7	11.8	20.0	37.5	15
107-T15-1	5	T15	3.3	11.8	20.0	37.5	15
107-T20-1	5	T20	3.8	11.8	20.0	37.5	15
107-T25-1	5	T25	4.4	11.8	20.0	37.5	15
107-T27-1	5	T27	5.0	11.8	20.0	37.5	16
107-T30-1	5	T30	5.5	11.8	20.0	37.5	16
107-T40-1	5	T40	6.6	11.8	20.0	37.5	16

1/4" ACCESSORIES

1/4" REVERSIBLE RATCHET

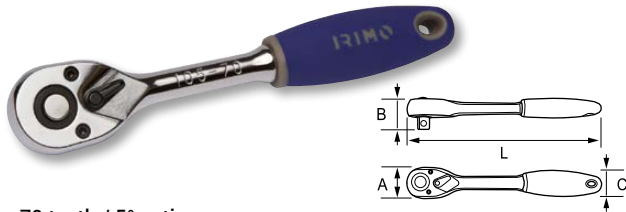

- 72 teeth / 5° action
- Chrome vanadium alloy steel
- Chrome-plated bright finish
- Quick release
- 2-component handle
- Cushion thermo rubber grip
- Standards: DIN 3120, DIN 3122

R	📦	A mm	B mm	C mm	L mm	g
105-70-1	5	28	25	23	152	151

1/4" REVERSIBLE RATCHET

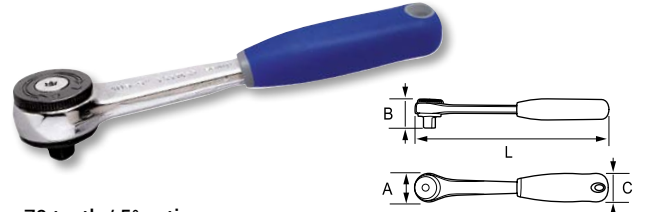

- 72 teeth / 5° action
- High performance alloy steel
- Chrome-plated high polished finish
- 2-component handle
- Cushion thermo rubber grip
- Standards: DIN 3122, DIN 3120, ISO 3315, UNE 16512
- 105.711 Repair Kit

R	📦	A mm	B mm	C mm	L mm	g
105501	1	25	23	21	122	150

RATCHET EXHIBITOR WITH 12 1/4" RATCHETS



- Reversible ratchet
- 72 teeth / 5° action
- Chrome vanadium alloy steel
- Chrome-plated bright finish
- Quick release
- 2-component handle
- Cushion thermo rubber grip
- Standard: DIN 3122, DIN 3120
- Use part number 105-70-1 to order individual ratchets



R	📦	📦	📏	g
105-70-12DISP	1	12	160 x 150 x 230	2.590

1/4" HEXAGONAL SOCKET SET IN RAIL, 11 pieces



- 1/4" Socket set in display
- 11 pcs socket set
- Hexagonal sockets, metric sizes
- Chrome plated bright finish
- Standard: DIN 3120, DIN 3124, DIN 3122
- Hang sell presentation

R	📦	📦	📏	g
109-11-4	5	11	232 x 60 x 15	250

101-04-1, 101-05-1, 101-06-1, 101-07-1, 101-08-1, 101-09-1, 101-10-1, 101-11-1, 101-12-1, 101-13-1, 101-14-1  

1/4" SOCKET SET, HEXAGONAL AND METRIC



- 13 pcs, 1/4" drive socket set
- Hexagonal sockets, metric sizes
- Chrome plated bright finish
- Standard: DIN 3120, DIN 3124, DIN 3122
- Hang sell presentation
- * Counter display when ordering 12 pieces

R	📦	📦	📏	g
109-13-4	8	13	254 x 70 x 30	460

105-70-1  105-24-1 
 101-04-1, 101-05-1, 101-06-1, 101-07-1, 101-08-1, 101-09-1, 101-10-1, 101-11-1, 101-12-1, 101-13-1, 101-14-1  

1/4" EXTENSIONS



- Standards: DIN 3120, DIN 3122

R	Icon	A mm	B mm	L mm	g	
105-22-1		5	8.1	12.2	50	20
105-24-1		5	8.1	12.2	100	38
105-26-1		5	8.1	12.2	150	65

1/4" SLIDING T-HANDLE

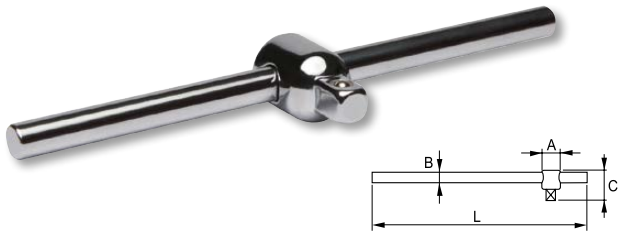

- Standards: DIN 3120, DIN 3122

R	Icon	A mm	B mm	C mm	L mm	g	
105-42-1		5	13.5	6.0	24	115	45

1/4" FLEXIBLE EXTENSION

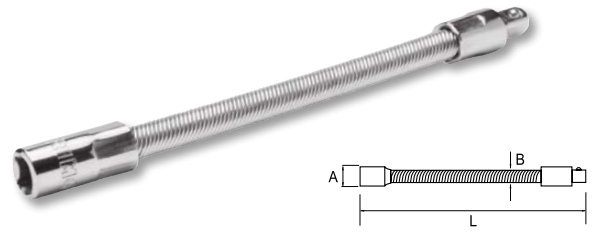

- Standard: DIN 3120

R	Icon	A mm	B mm	L mm	g	
105-28-1		5	12.5	8	148	57

1/4" SPINNER HANDLE

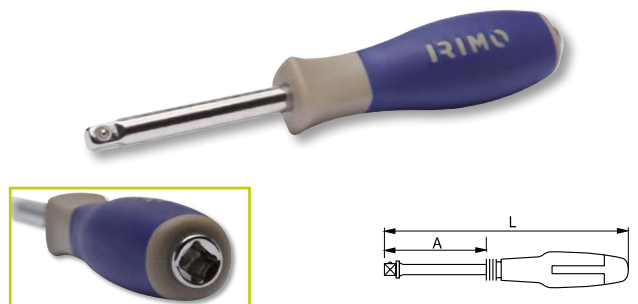

- Female 1/4" square in the head
- Standard: DIN 3120

R	Icon	A mm	L mm	□	□	g	
105-50-1		5	61	150	1/4"	1/4"	88

1/4" UNIVERSAL JOINT

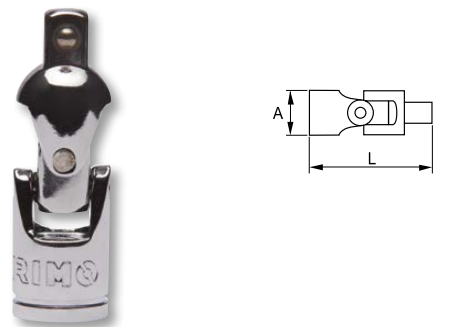

- Standards: DIN 3120, DIN 3122

R	Icon	A mm	L mm	g	
105-40-1		5	13.8	38.0	27

1/4"-3/8" INCREASING ADAPTOR

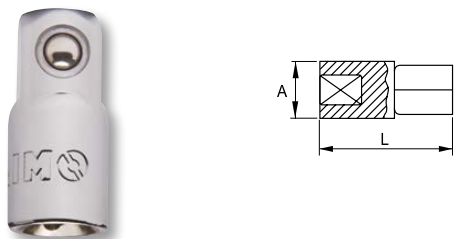

- Increasing adaptor 1/4" to 3/8"
- Standards: DIN 3120, DIN 3122

R	Icon	A mm	L mm	g	
105-46-1		5	12.0	26.0	31

1/4" BIT HOLDER

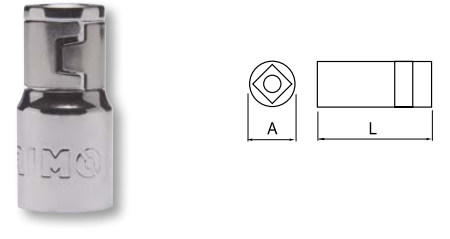

- 1/4" female square to 1/4" female hex
- Standard: DIN 3120

R	Icon	A mm	L mm	g	
105-48-1		5	11.9	25.0	12



1/4" SOCKET SETS

1/4" SOCKET AND BIT SET



- 1/4" 23 pcs socket and bit set DIN 3120 and DIN 3124
- Ratchet torque according to DIN 3122
- Special bit ratchet hex 1/4" drive; Reversible; 60 teeth; L= 90 mm
- Bimaterial ratchet handle
- ABS plastic box
- Includes belt clip
- Ratchet is sold as a spare part: SP121

Part No.	Qty	Box Qty	Dimensions	Weight
109-23-4	1	23	110x75x45	340
101-06-1, 101-07-1, 101-08-1, 101-10-1, 101-11-1, 101-13-1			1/4"	
475A-25-1				
475-PH1-1, 475-PH2-1				
475-PZ1-1, 475-PZ2-1				
475-4-1, 475-6.0-1				
475-H3-1, 475-H4-1, 475-H5-1, 475-H6-1				
475-T10-1, 475-T15-1, 475-T20-1, 475-T25-1, 475-T30-1				
SP121				

1/4" SOCKET SET, HEXAGONAL AND METRIC



- Hex sockets, metric sizes
- Chrome vanadium alloy steel
- Chrome-plated bright finish
- Standards: DIN 3120, DIN 3124, DIN 3122
- Box in high density polyethylene

Part No.	Qty	Box Qty	Dimensions	Weight
109-19-4	10	19	260x185x55	1.100
105-40-1				
105-42-1				
105-22-1				
105-70-1				
105-50-1				
105-26-1				
101-04-1, 101-045-1, 101-05-1, 101-055-1, 101-06-1, 101-07-1, 101-08-1, 101-09-1, 101-10-1, 101-11-1, 101-12-1, 101-13-1, 101-14-1			1/4"	

1/4" SOCKET SET, HEXAGONAL AND METRIC



- 35 pcs socket set
- Hex sockets, metric sizes
- Chrome vanadium alloy steel
- Chrome-plated bright finish
- Standards: DIN 3120, DIN 3124, DIN 3122
- Box in high density polyethylene

Part No.	Qty	Box Qty	Dimensions	Weight
109-35-4	1	35	250 x 170 x 60	1.200
105-48-1				
105-42-1				
105-22-1				
105-24-1				
105-70-1				
105-50-1				
105-40-1				
101-04-1, 101-045-1, 101-05-1, 101-055-1, 101-06-1, 101-07-1, 101-08-1, 101-09-1, 101-10-1, 101-11-1, 101-12-1, 101-13-1			1/4"	
040001, 040011, 040021				
475-PH1-1, 475-PH2-1, 475-PH3-1				
475-PZ1-1, 475-PZ2-1, 475-PZ3-1				
475-4-1, 475-6.0-1				
475-H3-1, 475-H4-1, 475-H5-1, 475-H6-1				

3/8" SOCKETS

3/8" HEXAGONAL SOCKETS

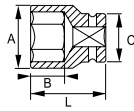

- Chrome vanadium alloy steel
- Chrome-plated bright finish
- Wave shape profile NPP
- Standards: DIN 3120, DIN 3124

Part No.	Box	Hex	A mm	B mm	C mm	L mm	g
112-06-1	5	6	10.5	9.0	17.0	28.0	21
112-07-1	5	7	11.0	9.0	17.0	28.0	24
112-08-1	5	8	12.2	9.0	17.0	28.0	27
112-09-1	5	9	13.5	9.0	17.0	28.0	26
112-10-1	5	10	14.7	9.0	17.0	28.0	24
112-11-1	5	11	16.0	9.0	17.0	28.0	26
112-12-1	5	12	18.0	15.0	17.0	28.0	24
112-13-1	5	13	19.0	15.0	17.0	28.0	29
112-14-1	5	14	20.0	15.0	17.7	28.0	38
112-15-1	5	15	22.0	15.0	17.9	28.0	40
112-16-1	5	16	22.0	15.0	17.9	28.0	46
112-17-1	5	17	24.0	15.0	18.8	30.0	56
112-18-1	5	18	26.0	15.0	19.8	30.0	75
112-19-1	5	19	26.0	15.0	20.7	30.0	66
112-20-1	5	20	28.0	15.0	21.8	30.0	88
112-21-1	5	21	28.0	15.0	21.8	30.0	84
112-22-1	5	22	30.0	15.0	22.8	32.0	104

3/8" HEXAGONAL DEEP SOCKETS

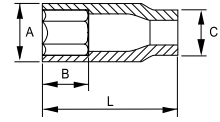

- Deep sockets
- Chrome vanadium alloy steel
- Chrome-plated bright finish
- Wave shape profile NPP
- Standard: DIN 3120

Part No.	Box	Hex	A mm	B mm	C mm	L mm	g
113-07-1	5	7	11.0	16.0	17.0	64.0	45
113-08-1	5	8	12.2	16.0	17.0	64.0	49
113-09-1	5	9	13.5	16.0	17.0	64.0	53
113-10-1	5	10	14.7	16.0	17.0	64.0	60
113-11-1	5	11	17.0	29.0	16.0	64.0	61
113-12-1	5	12	18.0	29.0	17.2	64.0	63
113-13-1	5	13	19.0	29.0	16.8	64.0	75
113-14-1	5	14	20.0	29.0	17.8	64.0	81
113-16-1	5	16	22.0	29.0	18.0	64.0	98
113-17-1	5	17	24.0	29.0	18.9	64.0	123
113-19-1	5	19	26.0	29.0	20.8	64.0	145



3/8" ACCESSORIES

3/8" REVERSIBLE RATCHET

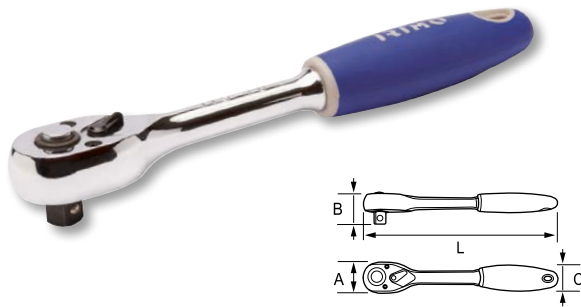

- 72 teeth / 5° action
- Chrome vanadium alloy steel
- Chrome-plated bright finish
- Quick release
- 2-component handle
- Cushion thermo rubber grip
- Standards: DIN 3120, DIN 3122

Part No.	Pack	A mm	B mm	C mm	L mm	g
115-70-1	5	33	33	32	202	341

3/8" REVERSIBLE RATCHET

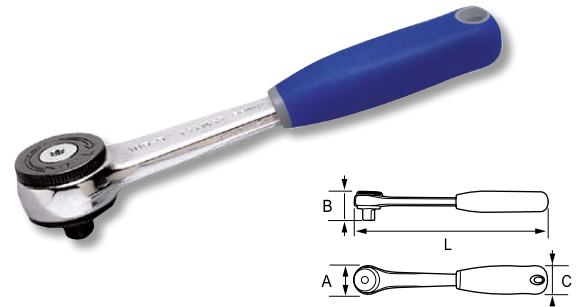

- 72 teeth / 5° action
- High performance alloy steel
- Chrome-plated high polished finish
- 2-component handle
- Cushion thermo rubber grip
- Standards: DIN 3122, DIN 3120, ISO 3315, UNE 16512
- 105.701 Repair Kit

Part No.	Pack	A mm	B mm	C mm	L mm	g
115501	1	29	30	24	197	230

3/8" EXTENSIONS



- Standards: DIN 3120, DIN 3122

Part No.	Pack	A mm	B mm	L mm	g
115-20-1	5	17.0	12.1	75	125
115-22-1	5	17.0	12.1	150	138
115-24-1	5	17.0	12.1	250	232

3/8" SLIDING T-HANDLE



- Standards: DIN 3120, DIN 3122

Part No.	Pack	A mm	B mm	C mm	L mm	g
115-42-1	5	17.5	8.5	35	152	114

3/8" T-HANDLE HEAD

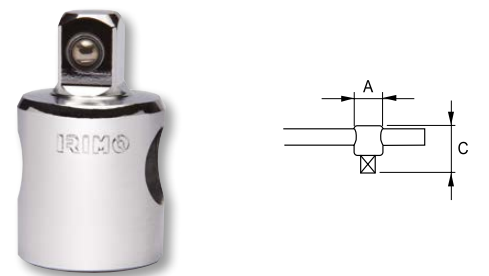

- Sliding T handle head
- Standard: DIN 3120

Part No.	Pack	A mm	C mm	g
115-43-1	5	24.0	40.5	30

3/8" UNIVERSAL JOINT



- Standards: DIN 3120, DIN 3122

Part No.	Icon	A mm	L mm	Weight (g)
115-40-1	5	17.8	59.0	61

3/8"-1/4" REDUCING ADAPTOR



- Reducing adaptor 3/8" to 1/4"
- Standard: DIN 3120

Part No.	Icon	A mm	L mm	Weight (g)
115-46-1	5	16.0	25.0	17

3/8"-1/2" INCREASING ADAPTOR



- Increasing adaptor 3/8" to 1/2"
- Standard: DIN 3120

Part No.	Icon	A mm	L mm	Weight (g)
115-44-1	5	18.0	35.5	45

3/8" BIT HOLDER



- 3/8" female square to 5/16" female hex
- Standard: DIN 3120

Part No.	Icon	Size	A mm	L mm	Weight (g)
115-48-1	5	5/16"	15.4	28.0	24

3/8" SOCKET SET

3/8" SOCKET SET, HEXAGONAL AND METRIC



- 3/8" Socket set, 18 pcs
- Hex sockets, metric sizes
- Chrome vanadium alloy steel
- Chrome-plated bright finish
- Standards: DIN 3120, DIN 3124, DIN 3122
- Box in high density polyethylene

Part No.	Icon	Quantity	Dimensions	Weight (g)
119-18-4	18	18	320 x 250 x 75	3.250
112-07-1, 112-08-1, 112-10-1, 112-11-1, 112-12-1, 112-13-1, 112-14-1, 112-15-1, 112-16-1, 112-17-1, 112-19-1, 112-21-1, 112-22-1	3/8"			
115-70-1	Icon			
115-20-1, 115-22-1	Icon			
115-40-1	Icon			
115-43-1	Icon			



1/2" SOCKETS

1/2" HEXAGONAL SOCKETS

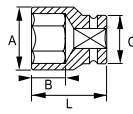

- Chrome vanadium alloy steel
- Chrome-plated bright finish
- Wave shape profile NPP
- Standards: DIN 3120, DIN 3124

R			A mm	B mm	C mm	L mm	g
121-08-1	5	8	14.8	13.0	22.0	38.0	50
121-09-1	5	9	15.3	13.0	22.0	38.0	48
121-10-1	5	10	15.3	13.0	22.0	38.0	49
121-11-1	5	11	16.5	13.0	22.0	38.0	50
121-12-1	5	12	17.8	13.0	22.0	38.0	52
121-13-1	5	13	19.0	13.0	22.0	38.0	54
121-14-1	5	14	20.3	13.0	22.0	38.0	56
121-15-1	5	15	22.0	17.8	20.5	38.0	57
121-16-1	5	16	22.0	17.8	20.5	38.0	71
121-17-1	5	17	24.0	17.8	21.9	38.0	72
121-18-1	5	18	25.0	17.8	22.9	38.0	90
121-19-1	5	19	26.0	17.8	22.9	38.0	84
121-20-1	5	20	28.0	17.8	23.9	38.0	87
121-21-1	5	21	28.0	17.8	23.9	38.0	95
121-22-1	5	22	30.0	17.8	26.1	38.0	97
121-23-1	5	23	32.0	17.8	28.1	38.0	103
121-24-1	5	24	32.0	17.8	28.1	38.0	109
121-25-1	5	25	34.0	17.8	29.1	40.0	146
121-26-1	5	26	34.0	17.8	29.1	42.0	192
121-27-1	5	27	36.0	17.8	30.1	42.0	211
121-28-1	5	28	38.0	17.8	32.1	42.0	212
121-30-1	5	30	40.0	17.8	34.1	44.0	214
121-32-1	5	32	42.0	17.8	36.1	44.0	217
121-34-1	5	34	50.0	18.0	38.0	44.0	260
121-36-1	5	36	52.0	18.2	40.0	45.0	300

1/2" BIHEXAGONAL SOCKETS

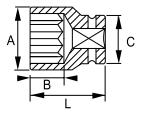

- Chrome vanadium alloy steel
- Chrome-plated bright finish
- Wave shape profile NPP
- Standards: DIN 3120, DIN 3124

R			A mm	B mm	C mm	L mm	g
122-08-1	5	8	14.8	13.0	22.0	38.0	50
122-09-1	5	9	15.3	13.0	22.0	38.0	48
122-10-1	5	10	15.3	13.0	22.0	38.0	49
122-11-1	5	11	16.5	13.0	22.0	38.0	50
122-12-1	5	12	17.8	13.0	22.0	38.0	52
122-13-1	5	13	19.0	13.0	22.0	38.0	54
122-14-1	5	14	20.3	13.0	22.0	38.0	56
122-15-1	5	15	22.0	17.8	20.5	38.0	57
122-16-1	5	16	22.0	17.8	20.5	38.0	71
122-17-1	5	17	24.0	17.8	21.9	38.0	72
122-18-1	5	18	25.0	17.8	22.9	38.0	90
122-19-1	5	19	26.0	17.8	22.9	38.0	84
122-20-1	5	20	28.0	17.8	23.9	38.0	87
122-21-1	5	21	28.0	17.8	23.9	38.0	95
122-22-1	5	22	30.0	17.8	26.1	38.0	97
122-23-1	5	23	32.0	17.8	28.1	38.0	103
122-24-1	5	24	32.0	17.8	28.1	38.0	109
122-27-1	5	27	36.0	17.8	30.1	42.0	211
122-30-1	5	30	40.0	17.8	34.1	44.0	214
122-32-1	5	32	42.0	17.8	36.1	44.0	217
122-34-1	5	34	44.0	17.8	37.1	45.0	220
122-36-1	5	36	44.0	17.8	38.1	44.0	220



R			A mm	B mm	C mm	L mm	g
122A-10-1	5	5/16"	14.8	13.0	22.0	38.0	50
122A-11-1	5	11/32"	15.3	13.0	22.0	38.0	48
122A-12-1	5	3/8"	15.5	13.0	22.0	38.0	45
122A-14-1	5	7/16"	16.7	13.0	22.0	38.0	49
122A-16-1	5	1/2"	19.2	13.0	22.0	38.0	54
122A-18-1	5	9/16"	20.5	13.0	22.0	38.0	55
122A-20-1	5	5/8"	22.0	17.8	20.6	38.0	69
122A-22-1	5	11/16"	24.0	17.8	21.9	38.0	71
122A-24-1	5	3/4"	26.0	17.8	22.9	38.0	75
122A-26-1	5	13/16"	28.0	17.8	23.9	38.0	76
122A-28-1	5	7/8"	30.0	17.8	26.1	38.0	88
122A-30-1	5	15/16"	32.0	17.8	28.1	38.0	104
122A-34-1	5	1.1/16"	36.0	17.8	30.1	42.0	141
122A-38-1	5	1.3/16"	40.0	17.8	34.1	44.0	214
122A-40-1	5	1.1/4"	42.0	17.8	36.1	44.0	233

1/2" BIHEXAGONAL DEEP SOCKETS

12 mm

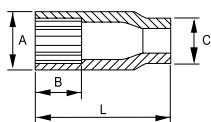

- 1/2" Sockets, long
- Chrome vanadium alloy steel
- Chrome-plated bright finish
- Wave shape profile NPP
- Standards: DIN 3120, DIN 3124

E	Box	mm	A mm	B mm	C mm	L mm	g
124-10-1	5	10	15.3	27.0	22.0	78.0	78
124-11-1	5	11	16.5	27.0	22.0	78.0	86
124-12-1	5	12	17.8	27.0	22.0	78.0	103
124-13-1	5	13	19.0	27.0	22.0	78.0	108
124-14-1	5	14	20.3	27.0	22.0	78.0	109
124-15-1	5	15	22.0	31.0	22.0	78.0	113
124-16-1	5	16	22.0	31.0	22.0	78.0	115
124-17-1	5	17	24.0	31.0	22.0	78.0	123
124-18-1	5	18	25.0	31.0	22.8	78.0	149
124-19-1	5	19	26.0	31.0	22.8	78.0	135
124-21-1	5	21	28.0	31.0	23.8	78.0	151
124-22-1	5	22	30.0	31.0	26.0	78.0	190
124-24-1	5	24	32.0	31.0	28.0	78.0	220
124-27-1	5	27	36.0	31.0	30.0	78.0	250
124-30-1	5	30	40.0	31.0	34.0	78.0	341
124-32-1	5	32	42.0	31.0	36.0	78.0	382

12 in

E	Box	in	A mm	B mm	C mm	L mm	g
124A-18-1	5	9/16"	22.0	31.0	22.0	78.0	113
124A-20-1	5	5/8"	22.0	31.0	22.0	78.0	115
124A-22-1	5	11/16"	25.0	31.0	22.8	78.0	149
124A-24-1	5	3/4"	26.0	31.0	22.8	78.0	135
124A-26-1	5	13/16"	28.0	31.0	23.8	78.0	151

1/2" SOCKETS, TORX®

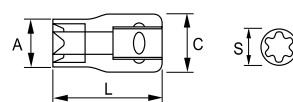

- Standard: DIN 3120

E	Box	Symbol	S mm	A mm	C mm	L mm	g
126-10-1	5	E-10	9.4	14.7	22.0	38.0	55
126-11-1	5	E-11	10.0	15.2	22.0	38.0	53
126-12-1	5	E-12	11.1	16.0	22.0	38.0	57
126-14-1	5	E-14	12.9	17.0	22.0	38.0	59
126-16-1	5	E-16	14.7	22.0	20.1	38.0	65
126-18-1	5	E-18	16.6	24.0	21.8	38.0	77
126-20-1	5	E-20	18.4	24.0	21.8	38.0	73
126-24-1	5	E-24	22.1	28.0	23.8	38.0	110



1/2" BIT DRIVERS

1/2" BIT DRIVER, HEXAGONAL



- Hexagonal bit driver
- Standard: DIN 3120 / ISO 1174

Part No.	Box	Bit	A mm	B mm	L mm	g
180-04-1	5	4	21.8	22	60	70
180-05-1	5	5	21.8	22	60	71
180-06-1	5	6	21.8	22	60	72
180-07-1	5	7	21.8	22	60	72
180-08-1	5	8	21.8	22	60	73
180-10-1	5	10	21.8	22	60	81
180-12-1	5	12	21.8	22	60	89
180-14-1	5	14	21.8	22	60	96
180-17-1	5	17	23.8	22	60	100
180-19-1	5	19	23.8	22	60	100

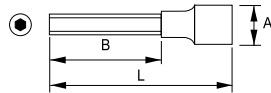

Part No.	Box	Bit	A mm	B mm	L mm	g
180-05X-1	5	5	21.8	62	100	89
180-06X-1	5	6	21.8	62	100	90
180-07X-1	5	7	21.8	62	100	91
180-08X-1	5	8	21.8	62	100	91
180-10X-1	5	10	21.8	62	100	109
180-12X-1	5	12	21.8	62	100	130

1/2" BIT DRIVER, TORX®



- TORX® Bit driver
- Standard: DIN 3120 / ISO 1174

Part No.	Box	Bit	S mm	A mm	B mm	L mm	g
183-20-1	5	T20	3.84	21.8	22	60	69
183-25-1	5	T25	4.40	21.8	22	60	69
183-27-1	5	T27	4.96	21.8	22	60	70
183-30-1	5	T30	5.49	21.8	22	60	70
183-40-1	5	T40	6.60	21.8	22	60	70
183-45-1	5	T45	7.77	21.8	22	60	70
183-50-1	5	T50	8.79	21.8	22	60	71
183-55-1	5	T55	11.17	21.8	22	60	76
183-60-1	5	T60	13.20	21.8	22	60	81

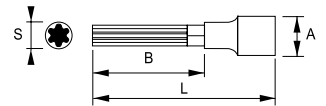

Part No.	Box	Bit	S mm	A mm	B mm	L mm	g
183-40X-1	5	T40	6.60	21.8	82	120	95
183-45X-1	5	T45	7.77	21.8	82	120	96
183-50X-1	5	T50	8.79	21.8	82	120	98
183-55X-1	5	T55	11.17	21.8	102	140	117

1/2" HEX BIT DRIVERS SOCKET SET



- 9 pcs bit driver set 1/2"
- Metric hexagonal bits
- Bright chrome socket
- Black finish bit
- Standard: DIN 3120 / ISO 1174
- Box in high density polyethylene

Part No.	Box	Box Qty	Box Dim	g
129-9H-4	1	9	55 x 200 x 160	1.080

180-04-1, 180-05-1, 180-06-1, 180-07-1, 180-08-1, 180-10-1, 180-12-1, 180-14-1, 180-17-1

1/2" TORX® BIT DRIVER SOCKET SET



- 9 pcs bit driver set 1/2"
- TORX® bits
- Bright chrome socket
- Black finish bit
- Standard: DIN 3120 / ISO 1174
- Box in high density polyethylene

Part No.	Box	Box Qty	Box Dim	g
129-9T-4	1	9	55 x 200 x 160	1.140

183-20-1, 183-25-1, 183-27-1, 183-30-1, 183-40-1, 183-45-1, 183-50-1, 183-55-1, 183-60-1

1/2" BIT DRIVER, XZN

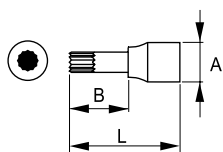

- XZN Bit driver
- Standard: DIN 3120 / ISO 1174

Q	Box	Symbol	A mm	B mm	L mm	g
185-05-1	5	M 5	21.8	22	60	67
185-06-1	5	M 6	21.8	22	60	69
185-08-1	5	M 8	21.8	22	60	69
185-10-1	5	M 10	21.8	22	60	77
185-12-1	5	M 12	21.8	22	60	85
185-14-1	5	M 14	21.8	22	60	90
185-16-1	5	M 16	21.8	22	60	95

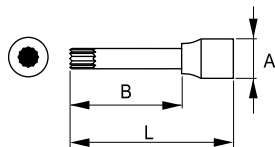

Q	Box	Symbol	A mm	B mm	L mm	g
185-06X-1	5	M 6	21.8	62	100	87
185-08X-1	5	M 8	21.8	62	100	89
185-10X-1	5	M 10	21.8	62	100	105
185-12X-1	5	M 12	21.8	62	100	123

1/2" ACCESSORIES

1/2" REVERSIBLE RATCHET

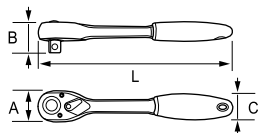

- 72 teeth / 5° action
- Chrome vanadium alloy steel
- Chrome-plated bright finish
- Quick release
- 2-component handle
- Cushion thermo rubber grip
- Standard: DIN 3122, DIN 3120

Q	Box	A mm	B mm	C mm	L mm	g
125-70-1	5	42	41	36	262	591

1/2" SOCKET DRIVERS FOR TORX® TAMPER SCREWS



- 1/2" socket drivers for TORX® tamper screws
- Finish: zinc phosphated
- Material: high performance alloy steel
- In plastic bag of 1 piece

Q	Box	Symbol	Symbol	L mm	L1 mm	g
T49T30XL	1	TR30	1/2"	200	160	122
T49T40XL	1	TR40	1/2"	200	160	123
T49T45XL	1	TR45	1/2"	200	160	125
T49T70HL	1	TR70	1/2"	100	60	167
T49T80HL	1	TR80	1/2"	100	30	163

1/2" REVERSIBLE RATCHET

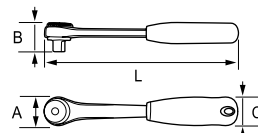

- 72 teeth / 5° action
- High performance alloy steel
- Chrome-plated high polished finish
- 2-component handle
- Cushion thermo rubber grip
- Standards: DIN 3122, DIN 3120, ISO 3315, UNE 16512

Q	Box	A mm	B mm	C mm	L mm	g
125501	1	39	41	30	251	614

1/2" ACCESSORIES

RATCHET EXHIBITOR WITH 12 1/2" RATCHETS



- Reversible ratchet
- 72 teeth / 5° action
- Chrome vanadium alloy steel
- Chrome-plated bright finish
- Quick release
- 2-component handle
- Cushion thermo rubber grip
- Standard: DIN 3122, DIN 3120
- Use part number 125-70-1 to order individual ratchets

125-70-12DISP	1	12	225 x 295 x 220	7.852

1/2" HEXAGONAL SOCKET SET IN RAIL, 10 pieces



- 1/2" Socket set in display
- 10 pcs socket set
- Hexagonal sockets, metric sizes
- Chrome plated bright finish
- Standard: DIN 3120, DIN 3124, DIN 3122
- Hang sell presentation

129-10-4	5	10	360 x 90 x 15	800

121-10-1, 121-12-1, 121-13-1, 121-14-1, 121-16-1, 121-17-1, 121-19-1, 121-21-1, 121-22-1, 121-24-1

1/2" SOCKET SET, HEXAGONAL AND METRIC



- 12 pcs socket set
- Hexagonal sockets, metric sizes
- Chrome plated bright finish
- Standards: DIN 3120, DIN 3124, DIN 3122
- Hang sell presentation
- * Counter display when ordering 8 pieces

129-12-4	8	12	330 x 100 x 50	1.600

125-70-1 125-23-1
 121-10-1, 121-12-1, 121-13-1, 121-14-1, 121-16-1, 121-17-1, 121-19-1, 121-21-1, 121-22-1, 121-24-1

1/2" EXTENSIONS



- Standards: DIN 3120, DIN 3122

		A mm	B mm	L mm	
125-22-1	5	22.4	15.7	75	120
125-23-1	5	22.4	15.7	125	193
125-25-1	5	22.4	15.7	250	380

1/2" SWIVEL HANDLE

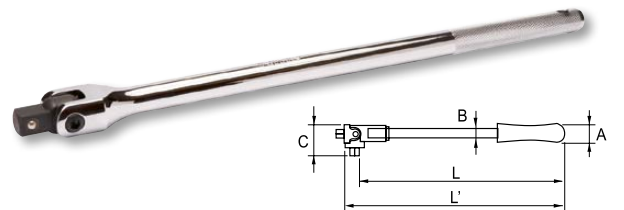

- Standard: DIN 3120

		A mm	B mm	C mm	L' mm	L mm	
125-52-1	5	35	12	40	375	355.0	692

1/2" SPEED BRACE

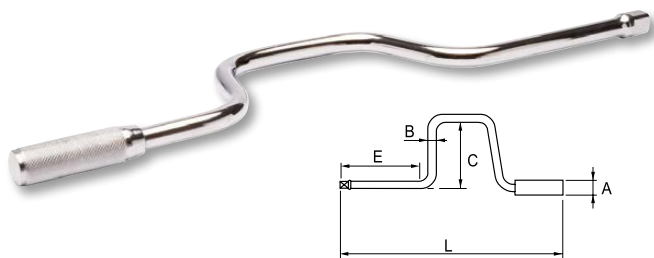

- Standards: DIN 3120, DIN 3122

Part No.	PKT	A mm	B mm	C mm	E mm	L mm	g
125-49-1	5	31.0	12.7	75	152	420	575

1/2" SLIDING T-HANDLE



- Standards: DIN 3120, DIN 3122

Part No.	PKT	A mm	B mm	C mm	L mm	g
125-42-1	5	23.5	13.5	45	250	272

1/2" T-HANDLE HEAD

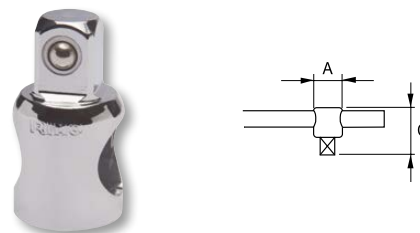

- Sliding T handle head
- Standard: DIN 3120

Part No.	PKT	A mm	C mm	g
125-43-1	5	24.0	44	73

1/2"-3/8" REDUCING ADAPTOR



- Reducing adaptor 1/2" to 3/8"
- Standards: DIN 3120, DIN 3122

Part No.	PKT	A mm	L mm	g
125-46-1	5	22.0	35.5	45

1/2"-3/4" INCREASING ADAPTOR



- Increasing adaptor 1/2" to 3/4"
- Standards: DIN 3120, DIN 3122

Part No.	PKT	A mm	L mm	g
125-44-1	5	25.0	50.0	140

1/2" L-HANDLE

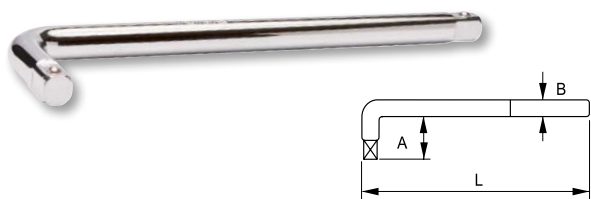

- Standards: DIN 3120, DIN 3122

Part No.	PKT	A mm	B mm	L mm	g
125-60-1	5	46	14	250	456

1/2" SPARK PLUG SOCKET

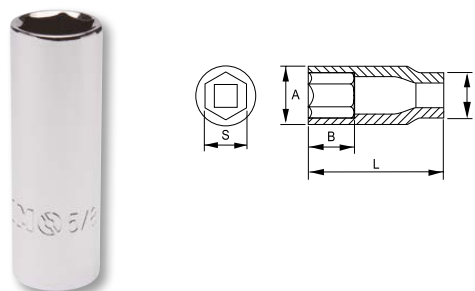

Part No.	PKT	S mm	A mm	B mm	C mm	L mm	g
125-53-1	5	5/8" - 16	22.0	32.0	22.0	65.0	90
125-54-1	5	13/16" - 21	28.0	31.0	24.0	65.0	146

1/2" ACCESSORIES

1/2" UNIVERSAL JOINT



- Standards: DIN 3120, DIN 3122

R	Icon	A mm	L mm	g
125-40-1	5	23.8	72.0	146

1/2" BIT HOLDER



- 1/2" female square to 5/16" female hex
- Standard: DIN 3120

R	Icon	A mm	L mm	g
125-48-1	5	17.0	38.5	56

1/2" SOCKET SETS

1/2" SOCKET SET, HEXAGONAL AND METRIC



- 23 pcs socket set
- Hex sockets, metric sizes
- Chrome vanadium alloy steel
- Chrome-plated bright finish
- Standards: DIN 3120, DIN 3124, DIN 3122
- Box in high density polyethylene
- Box with metal locks

R	Icon	X	Icon	g
129-23-4	1	23	320x250x75	3.500

125-70-1		125-43-1	
125-25-1		125-23-1	
125-40-1			
121-08-1, 121-10-1, 121-12-1, 121-13-1, 121-14-1, 121-16-1, 121-17-1, 121-19-1, 121-20-1, 121-21-1, 121-22-1, 121-23-1, 121-24-1, 121-26-1, 121-27-1, 121-28-1, 121-30-1, 121-32-1			

1/2" SOCKET SET, HEXAGONAL AND METRIC



- 33 pcs sockets and wrenches set
- Hex sockets, metric sizes
- Combination wrenches, metric sizes
- Chrome vanadium alloy steel
- Chrome-plated bright finish
- Standards: DIN 3120, DIN 3124, DIN 3122
- Box in high density polyethylene
- Box with metal locks

R	Icon	X	Icon	g
129-33W-4	1	33	320x250x75	5.020

125-70-1		125-43-1	
125-25-1		125-23-1	
125-40-1			
25-08-1, 25-09-1, 25-10-1, 25-11-1, 25-12-1, 25-13-1, 25-14-1, 25-15-1, 25-17-1, 25-19-1			
121-08-1, 121-10-1, 121-12-1, 121-13-1, 121-14-1, 121-16-1, 121-17-1, 121-19-1, 121-20-1, 121-21-1, 121-22-1, 121-23-1, 121-24-1, 121-26-1, 121-27-1, 121-28-1, 121-30-1, 121-32-1			

1/4"-1/2" SOCKET SET, HEXAGONAL AND METRIC

1/4" 1/2" mm



- 58 pcs socket set
- Hex sockets, metric sizes
- Chrome vanadium alloy steel
- Chrome-plated bright finish
- Standards: DIN 3120, DIN 3124, DIN 3122
- Box in high density polyethylene
- Box with metal locks

Part No.	Qty	Box Qty	Box Dim (mm)	Weight (g)
129-58-4	1	58	380x280x80	4.750
105-50-1		105-70-1		
105-42-1		105-40-1		
105-22-1		105-24-1		
125-70-1		125-43-1		
125-25-1		125-40-1		
125-23-1				
101-04-1, 101-045-1, 101-05-1, 101-055-1, 101-06-1, 101-07-1, 101-08-1, 101-09-1, 101-10-1, 101-11-1, 101-12-1, 101-13-1	1/4"			
121-08-1, 121-10-1, 121-12-1, 121-13-1, 121-14-1, 121-16-1, 121-17-1, 121-19-1, 121-20-1, 121-21-1, 121-22-1, 121-23-1, 121-24-1, 121-26-1, 121-27-1, 121-28-1, 121-30-1, 121-32-1	1/2"			
040001, 040011, 040021				
475-PH1-1, 475-PH2-1, 475-PH3-1				
475-PZ1-1, 475-PZ2-1, 475-PZ3-1				
475-3-1, 475-4-1, 475-5.5-1				
475-H3-1, 475-H4-1, 475-H5-1, 475-H6-1				

1/4"-1/2" SOCKET SET, HEXAGONAL, INCHES

1/4" 1/2" in



- 53 pcs socket set
- Hexagonal sockets, AF
- Bright chrome plating finish
- Standards: DIN 3120, DIN 3124, DIN 3122
- Box in high density polyethylene
- Box with metal locks

Part No.	Qty	Box Qty	Box Dim (mm)	Weight (g)
129A-53-4	1	53	380x280x80	4.750
105-48-1		105-70-1		
105-42-1		105-50-1		
105-22-1		105-24-1		
105-40-1		125-70-1		
125-25-1		125-43-1		
125-23-1		125-40-1		
101A-05-1, 101A-06-1, 101A-07-1, 101A-08-1, 101A-09-1, 101A-10-1, 101A-11-1, 101A-12-1, 101A-14-1, 101A-16-1, 101A-18-1	1/4"			
122A-10-1, 122A-11-1, 122A-12-1, 122A-14-1, 122A-16-1, 122A-18-1, 122A-20-1, 122A-22-1, 122A-24-1, 122A-26-1, 122A-28-1, 122A-30-1, 122A-34-1, 122A-38-1, 122A-40-1	1/2"			
040001, 040011, 040021				
475-PH1-1, 475-PH2-1, 475-PH3-1				
475-PZ1-1, 475-PZ2-1, 475-PZ3-1				
475-3-1, 475-4-1, 475-5.5-1				
1/4" Hex 1/8", 5/32", 3/16", 7/32" AF				



1/2" SOCKET SETS

1/4"-1/2" SOCKET SET, HEXAGONAL AND METRIC



- 108 pcs socket set
- Hexagonal sockets, metric sizes
- Chrome plated, bright finish
- Standards: DIN 3120, DIN 3124, DIN 3122, ISO 10102
- Box in high density polyethylene
- Box with metal locks

R	Icons	1	108	380x280x80	g	7.100
105-48-1						
125-42-1						
105-22-1						
105-24-1						
125-48-1						
125-25-1						
125-40-1						
101-04-1, 101-045-1, 101-05-1, 101-055-1, 101-06-1, 101-07-1, 101-08-1, 101-09-1, 101-10-1, 101-11-1, 101-12-1, 101-13-1, 101-14-1						1/4"
103-06-1, 103-07-1, 103-08-1, 103-09-1, 103-10-1, 103-12-1, 103-13-1						1/4"
106-04-1, 106-05-1, 106-06-1, 106-07-1, 106-08-1						
121-10-1, 121-11-1, 121-12-1, 121-13-1, 121-14-1, 121-15-1, 121-16-1, 121-17-1, 121-18-1, 121-19-1, 121-20-1, 121-21-1, 121-22-1, 121-24-1, 121-27-1, 121-30-1, 121-32-1						1/2"
126-10-1, 126-11-1, 126-12-1, 126-14-1, 126-16-1, 126-18-1, 126-20-1, 126-24-1						
124-14-1, 124-15-1, 124-17-1, 124-19-1, 124-22-1						1/2"
125-53-1, 125-54-1						
107-T08-1, 107-T10-1, 107-T15-1, 107-T20-1, 107-T25-1, 107-T27-1, 107-T30-1						
107-H3-1, 107-H4-1, 107-H5-1, 107-H6-1						
107-PH1-1, 107-PH2-1						
107-PZ1-1, 107-PZ2-1						
107-0840-1, 107-1055-1, 107-1280-1						
040001, 040011, 040021						
045801, 045811, 045821						
470-10.0-1, 470-12.0-1, 470-8.0-1						
470-H10-1, 470-H7-1, 470-H8-1						
470-PH3-1, 470-PH4-1						
470-T40-1, 470-T45-1, 470-T50-1, 470-T55-1						

1/4"-1/2" SOCKET SET, HEXAGONAL, INCHES



- 103 pcs socket set, AF sizes
- Hexagonal sockets
- Bright chrome plating finish
- Standards: DIN 3120, DIN 3124, DIN 3122
- Box in high density polyethylene
- Box with metal locks

R	Icons	1	103	380x280x80	g	7.000
105-40-1						
105-42-1						
105-22-1						
125-70-1						
125-25-1						
125-23-1						
101A-05-1, 101A-06-1, 101A-07-1, 101A-08-1, 101A-10-1, 101A-11-1, 101A-12-1, 101A-14-1, 101A-16-1, 101A-18-1						1/4"
103A-06-1, 103A-08-1, 103A-09-1, 103A-10-1, 103A-11-1, 103A-12-1, 103A-14-1, 103A-16-1						1/4"
106-04-1, 106-05-1, 106-06-1, 106-07-1, 106-08-1, 106-10-1						
122A-12-1, 122A-14-1, 122A-16-1, 122A-18-1, 122A-20-1, 122A-22-1, 122A-24-1, 122A-26-1, 122A-28-1, 122A-40-1						1/2"
124A-18-1, 124A-20-1, 124A-22-1, 124A-24-1, 124A-26-1						1/2"
126-10-1, 126-11-1, 126-12-1, 126-14-1, 126-16-1, 126-18-1, 126-20-1, 126-24-1						
125-53-1, 125-54-1						
107-T08-1, 107-T09-1, 107-T10-1, 107-T15-1, 107-T20-1, 107-T25-1, 107-T27-1, 107-T30-1						
107A-4-1, 107A-5-1, 107A-6-1, 107A-7-1						
107-PH1-1, 107-PH2-1						
107-PZ1-1, 107-PZ2-1						
107-0840-1, 107-1055-1, 107-1280-1						
040001, 040011, 040021						
470-T40-1, 470-T45-1, 470-T50-1, 470-T55-1						
470-10.0-1, 470-12.0-1, 470-8.0-1						
470-H10-1, 470-H7-1, 470-H8-1						
470-PH3-1, 470-PH4-1						

1/4"-1/2" SOCKET SET, HEXAGONAL AND METRIC



- 101 pcs socket set
- Hex sockets, metric sizes
- Chrome vanadium alloy steel
- Chrome-plated bright finish
- Standards: DIN 3120, DIN 3124, DIN 3122
- Box in high density polyethylene
- Box with metal locks

Part No.	Qty	Code	Dimensions	Weight
129-101-4	1	101	380x280x80	7.000
105-48-1		105-70-1		
125-42-1		105-50-1		
105-22-1		105-40-1		
105-24-1		105-28-1		
125-70-1		125-43-1		
125-25-1		125-40-1		
125-23-1		125-48-1		
101-04-1, 101-045-1, 101-05-1, 101-055-1, 101-06-1, 101-07-1, 101-08-1, 101-09-1, 101-10-1, 101-11-1, 101-12-1, 101-13-1, 101-14-1				1/4"
103-06-1, 103-07-1, 103-08-1, 103-10-1, 103-11-1, 103-12-1, 103-13-1, 103-14-1				1/4"
121-08-1, 121-10-1, 121-12-1, 121-13-1, 121-14-1, 121-16-1, 121-17-1, 121-19-1, 121-20-1, 121-21-1, 121-22-1, 121-23-1, 121-24-1, 121-26-1, 121-27-1, 121-28-1, 121-30-1, 121-32-1				1/2"
124-13-1, 124-17-1, 124-19-1, 124-22-1				1/2"
107-T08-1, 107-T10-1, 107-T15-1, 107-T20-1, 107-T25-1, 107-T30-1				
107-H3-1, 107-H 4-1, 107-H5-1, 107-H6-1				
107-PH1-1, 107-PH2-1				
107-PZ1-1, 107-PZ2-1				
107-0840-1, 107-1055-1, 107-1280-1				
040001, 040011, 040021				
475-H3-1, 475-H4-1, 475-H5-1				
475-T10-1, 475-T15-1, 475-T20-1, 475-T25-1, 475-T27-1, 475-T30-1				
470-8.0-1, 470-10.0-1				
470-H6-1, 470-H7-1, 470-H8-1, 470-H10-1				
470-T30-1, 470-T40-1, 470-T45-1, 470-T50-1, 470-T55-1				

SOCKET SET 1/4", 3/8" AND 1/2"



- 172 pcs socket set
- Hexagonal sockets, metric sizes
- Chrome plated, bright finish
- DIN 3120, DIN 3124, DIN 3122, ISO 10102
- Box in high density polyethylene
- Box with metal locks

Part No.	Qty	Code	Dimensions	Weight
129-172-4	1	172	100x500x370	9.650
105-48-1		105-70-1		
105-42-1		105-50-1		
105-22-1		105-40-1		
105-24-1		115-70-1		
115-22-1		115-48-1		
115-40-1				
125-70-1		125-43-1		
125-25-1		125-40-1		
125-23-1		125-48-1		
101-04-1, 101-045-1, 101-05-1, 101-055-1, 101-06-1, 101-07-1, 101-08-1, 101-09-1, 101-10-1, 101-11-1, 101-12-1, 101-13-1, 101-14-1				1/4"
103-04-1, 103-05-1, 103-06-1, 103-07-1, 103-08-1, 103-09-1, 103-10-1				1/4"
106-04-1, 106-05-1, 106-06-1, 106-07-1, 106-08-1				
112-10-1, 112-11-1, 112-12-1, 112-13-1, 112-14-1, 112-15-1, 112-16-1, 112-17-1, 112-18-1, 112-19-1				3/8"
113-10-1, 113-11-1, 113-12-1, 113-13-1, 113-14-1, 113-15-1				3/8"
126-20-1, 126-24-1				
125-53-1, 125-54-1				
121-10-1, 121-11-1, 121-12-1, 121-13-1, 121-14-1, 121-15-1, 121-16-1, 121-17-1, 121-18-1, 121-19-1, 121-20-1, 121-21-1, 121-22-1, 121-24-1, 121-27-1, 121-30-1, 121-32-1				1/2"
107-T08-1, 107-T09-1, 107-T10-1, 107-T15-1, 107-T20-1, 107-T25-1, 107-T27-1, 107-T30-1				
107-H3-1, 107-H4-1, 107-H5-1, 107-H6-1				
107-PH0-1, 107-PH1-1, 107-PH2-1				
107-PZ0-1, 107-PZ1-1, 107-PZ2-1				
1/4" Drive bit socket: 4.5-5-6.5-7 mm				
1/4" Drive bit socket: T8H-T9H-T10H-T15H-T20H-T25H-T27H-T30H				
3/8" Drive E-Profile sockets: E10-E11-E12-E14-E16-E18				
3/8" Drive Spark Plug Socket: 16 mm				
1/2" Drive Deep Socket: (6 PT) 16-17-18-19-22 mm				1/2"
Hex Key Wrench: 1.5-2-2.5-3-4-5-6 mm				
20 pcs 1/4" bit 25 mm L W/ Holder: T8-T9-T10-T15-T20-T25-T27-T30-T40-T45 / H3-H4-H5-H6 / PH0-PH1-PH2 / PZ0-PZ1-PZ2				
24 pcs 8 mm Bit 30 mm L: T40-T45-T50-T55-T60-T70 / H7-H8-H10-H12-H14 / T40H-T45H-T50H-T55H-T60H-T70H / PH3-PH4 / PZ3-PZ4 / SL8-SL10-SL12				



1/2" SOCKET SETS

SOCKET SET 1/4, 3/8 AND 1/2"



- 164 pcs socket set
- Hex sockets, metric sizes
- Chrome vanadium alloy steel
- Chrome-plated bright finish
- Standards: DIN 3120, DIN 3124, DIN 3122
- Box in high density polyethylene
- Box with two extra locks to ensure the transport

R	📦	📦	📦	📦
149-164-4	1	164	490x370x100	12.919
105-48-1			105-70-1	
105-24-1			105-50-1	
105-22-1			105-40-1	
115-70-1			115-40-1	
115-20-1			115-24-1	
115-44-1			115-46-1	
125-70-1			125-40-1	
125-23-1			125-25-1	
115-48-1			612-160-1	
601-200-1			48-9-H	
475-5-1			475R-1/4-30	
101-04-1, 101-05-1, 101-055-1, 101-06-1, 101-07-1, 101-08-1, 101-09-1, 101-10-1, 101-11-1, 101-12-1				
103-04-1, 103-05-1, 103-06-1, 103-07-1, 103-08-1, 103-09-1, 103-10-1, 103-11-1, 103-12-1				
112-08-1, 112-09-1, 112-10-1, 112-11-1, 112-12-1, 112-13-1, 112-14-1, 112-15-1, 112-16-1, 112-17-1, 112-18-1, 112-19-1				
113-08-1, 113-09-1, 113-10-1, 113-11-1, 113-12-1, 113-13-1, 113-14-1, 113-16-1, 113-17-1, 113-19-1				
121-14-1, 121-17-1, 121-18-1, 121-19-1, 121-20-1, 121-21-1, 121-22-1, 121-24-1, 121-27-1, 121-30-1, 121-32-1				
124-12-1, 124-13-1, 124-14-1, 124-15-1, 124-17-1, 124-18-1, 124-19-1, 124-21-1, 124-22-1				
167-17-1, 167-19-1, 167-21-1, 167-23-1				
18-12-1, 18-13-1, 18-14-1				
25-08-1, 25-09-1, 25-10-1, 25-11-1, 25-12-1, 25-13-1, 25-14-1, 25-17-1, 25-18-1, 25-19-1				
475-T10-1, 475-T15-1, 475-T20-1, 475-T25-1, 475-T27-1, 475-T30-1, 475-T40-1				
475-TR10-1, 475-TR15-1, 475-TR20-1, 475-TR25-1, 475-TR27-1, 475-TR30-1, 475-TR40-1				
3/8" Drive Spark Plug Socket: 16-21 mm				
3/8" Drive bit socket: 3-4-5-6 mm				
3/8" Drive bit socket: PH1-PH2				
3/8" Drive bit socket: PZ1-PZ2				
3/8" Drive bit socket: TR10-TR15-TR20-TR25-TR27-TR30-TR40				

3/4" SOCKETS

3/4" HEXAGONAL SOCKETS

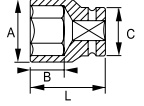

- Chrome vanadium alloy steel
- Chrome-plated bright finish
- Hexagonal
- Wave shape profile NPP
- Standards: DIN 3124, DIN 3120

R	📦	📏	A mm	B mm	C mm	L mm	g
131-19-1	1	19	30	12	36	50	200
131-21-1	1	21	32	12	36	50	215
131-22-1	1	22	33	12	36	50	215
131-23-1	1	23	34	14	36	50	215
131-24-1	1	24	34	16	36	50	215
131-25-1	1	25	38	16	36	50	220
131-26-1	1	26	38	16	36	52	220
131-27-1	1	27	38	18	36	52	240
131-28-1	1	28	38	18	36	52	250
131-29-1	1	29	42	18	38	52	260
131-30-1	1	30	42	20	38	52	275
131-32-1	1	32	44	22	38	52	310
131-33-1	1	33	46	22	38	55	340
131-34-1	1	34	46	22	38	57	330
131-35-1	1	35	48	24	42	57	380
131-36-1	1	36	50	24	42	57	415
131-38-1	1	38	52	26	44	57	455
131-40-1	1	40	56	27	44	63	505
131-41-1	1	41	56	27	44	63	545
131-42-1	1	42	58	27	44	63	600
131-46-1	1	46	62	30	44	68	650
131-50-1	1	50	68	33	44	72	755
131-55-1	1	55	75	36	48	75	1.000
131-60-1	1	60	80	39	48	77	1.100

3/4" SOCKETS

3/4" BIHEXAGONAL SOCKETS

12 mm

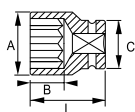

- Chrome vanadium alloy steel
- Chrome-plated bright finish
- Bi-Hexagonal
- Wave shape profile NPP
- Standards: DIN 3120, DIN 3124

Part No.	Box	Teeth	A mm	B mm	C mm	L mm	g
131B-19-2	1	19	30	12	36	50	200
131B-21-2	1	21	32	12	36	50	215
131B-22-2	1	22	33	12	36	50	215
131B-23-2	1	23	34	14	36	50	215
131B-24-2	1	24	34	16	36	50	215
131B-26-2	1	26	38	16	36	52	220
131B-27-2	1	27	38	18	36	52	240
131B-29-2	1	29	42	18	38	52	260
131B-30-2	1	30	42	20	38	52	275
131B-32-2	1	32	44	22	38	52	310
131B-35-2	1	35	48	24	42	57	380
131B-36-2	1	36	50	24	42	57	415
131B-38-2	1	38	52	26	44	57	455
131B-41-2	1	41	56	27	44	63	545
131B-46-2	1	46	56	27	44	63	545
131B-50-2	1	50	67	29	46	72	715

12 in

Part No.	Box	Teeth	A mm	B mm	C mm	L mm	g
132A-28-1	1	7/8"	33	12	36	50	215
132A-30-1	1	15/16"	35	16	36	50	215
132A-32-1	1	1"	38	16	36	52	200
132A-34-1	1	1.1/16"	38	18	36	54	240
132A-36-1	1	1.1/8"	42	18	38	55	280
132A-40-1	1	1.1/4"	44	22	38	55	310
132A-42-1	1	1.5/16"	46	22	38	57	340
132A-44-1	1	1.3/8"	48	24	42	57	380
132A-46-1	1	1.7/16"	50	24	42	57	415
132A-48-1	1	1.1/2"	52	26	44	57	455
132A-52-1	1	1.5/8"	56	27	44	63	545
132A-54-1	1	1.11/16"	58	27	44	63	600
132A-60-1	1	1.7/8"	65	30	44	68	700
132A-64-1	1	2"	68	33	44	72	755

3/4" ACCESSORIES

3/4" REVERSIBLE RATCHET HEAD

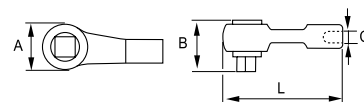

- 24 Teeth
- Chrome vanadium alloy steel
- Chrome-plated bright finish
- Quick release
- Standards: DIN 3120, DIN 3122

Part No.	Box	A mm	B mm	C mm	L mm	g
135-70-1	1	65	61.5	20	155	1.360

3/4" EXTENSIONS

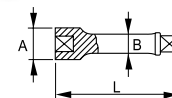

- Ball retaining system

Part No.	Box	A mm	B mm	L mm	g
135-21-1	1	36	23	125	515
135-22-1	1	36	23	200	725
135-24-1	1	36	23	400	1.350

3/4" RATCHET HANDLE

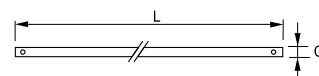

- Ratchet handle

Part No.	Box	C mm	L mm	g
135-85-1	1	20	450	1.100

3/4" SLIDING T-HANDLE

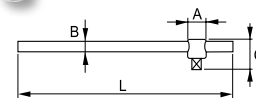

- Ball retaining system

Part No.	Box	A mm	B mm	C mm	L mm	g
135-42-1	1	36	20	60	450	1.335

3/4" ACCESSORIES

SLIDING T HANDLE HEAD

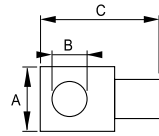

- Ball retaining system

R	Icon	A mm	B mm	C mm	g
135-43-1	1	35	20.5	60	235

3/4" UNIVERSAL JOINT

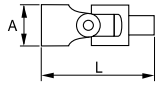

- Ball retaining system

R	Icon	A mm	L mm	g
135-40-1	1	40	108	540

3/4"-1/2" REDUCING ADAPTOR

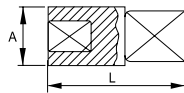

- Reducing adaptor 3/4" to 1/2"
- Ball retaining system

R	Icon	A mm	L mm	g
135-46-1	1	36	54	260

3/4" SWIVEL HANDLE

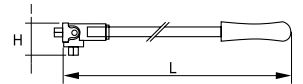

- Ball retaining system

R	Icon	H mm	L mm	g
135-52-1	1	40	450	1.700

3/4" SOCKET SETS

3/4" SOCKET SET, METRIC



- 17 pcs socket set
- Hex sockets, metric sizes
- Chrome vanadium alloy steel
- Chrome-plated bright finish
- Standards: DIN 3120, DIN 3124, DIN 3122
- Box in high density polyethylene
- Box with metal locks
- Spare Box part number: SP-106S-BOX17
- Two spare locks 3/4": SP104S

R	Icon	Icon	Icon	g
139-17-4	1	17	475x295x100	12.500

135-70-1		135-24-1	
135-22-1		135-43-1	
135-85-1			

131-22-1, 131-24-1, 131-27-1, 131-30-1, 131-32-1, 131-33-1, 131-34-1, 131-36-1, 131-38-1, 131-41-1, 131-46-1, 131-50-1

3/4" SOCKET SET, METRIC



- 21 pcs socket set
- Hexagonal sockets, metric sizes
- Chrome vanadium alloy steel
- Chrome plated bright finish
- Standards: DIN 3120, DIN 3124, DIN 3122
- Box in high density polyethylene
- Box with metal locks
- Spare Box part number: SP-106S-BOX21

R	Icon	Icon	Icon	g
139-21-4	1	21	475x295x100	11.900

135-70-1		135-24-1	
135-22-1		135-43-1	
135-85-1			

131-19-1, 131-21-1, 131-22-1, 131-23-1, 131-24-1, 131-26-1, 131-27-1, 131-29-1, 131-30-1, 131-32-1, 131-35-1, 131-36-1, 131-38-1, 131-41-1, 131-46-1, 131-50-1

3/4" SOCKET SET, METRIC

3/4" mm



- 21 pcs socket set
- Bihexagonal sockets, metric sizes
- Chrome vanadium alloy steel
- Chrome plated bright finish
- Standards: DIN 3120, DIN 3124, DIN 3122
- Box in high density polyethylene
- Box with metal locks
- Spare Box part number: SP-106S-BOX21

Part No.	Quantity	Material	Dimensions	Weight
139-21B-4	1	21	475x295x100	11.900
135-70-1		135-24-1		
135-22-1		135-43-1		
135-85-1				

131B-19-2, 131B-21-2, 131B-22-2, 131B-23-2, 131B-24-2, 131B-26-2, 131B-27-2, 131B-29-2, 131B-30-2, 131B-32-2, 131B-35-2, 131B-36-2, 131B-38-2, 131B-41-2, 131B-46-2, 131B-50-2

3/8" IMPACT SOCKETS

3/8" IMPACT HEXAGONAL SOCKETS, METRIC

6 mm

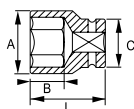

- Standards: UNE 16507, ISO 2725, DIN 3129

Part No.	Quantity	Material	A mm	B mm	C mm	L mm	Weight g
160-07-1	1	7	12.6	13	19	32	39
160-08-1	1	8	14	13	19	32	39
160-10-1	1	10	15.8	13	19	32	40
160-11-1	1	11	16.9	13	19	32	41
160-12-1	1	12	18.2	13	19	32	41
160-13-1	1	13	19.5	13	22	32	54
160-14-1	1	14	20.5	13	22	32	54
160-15-1	1	15	22	16	22	32	54
160-16-1	1	16	24	16	22	32	57
160-17-1	1	17	25	17	22	34	67
160-18-1	1	18	26	17	22	34	67
160-19-1	1	19	28	17	22	34	71
160-20-1	1	20	28	17	22	34	79
160-21-1	1	21	30	17	22	34	80
160-24-1	1	24	34	17	22	34	102

3/8" IMPACT HEXAGONAL SOCKETS, LONG SERIES, METRIC

6 mm

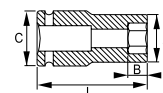

Part No.	Quantity	Material	A mm	B mm	C mm	L mm	Weight g
161-10-1	1	10	15.9	10	19	63	77
161-13-1	1	13	19.7	10	19	63	96
161-17-1	1	17	24.5	11	22	63	184

3/8" IMPACT ACCESSORIES

3/8" EXTENSIONS



- Standards: DIN 16503, ISO 1174

R	Icon	A mm	B mm	L mm	g
162-00-1	1	19	12.5	75	99
162-02-1	1	19	12.5	150	159

3/8" UNIVERSAL JOINT



- Standards: DIN 16503, ISO 1174

R	Icon	A mm	L mm	g
162-50-1	1	22	50	124

3/8"-1/4" REDUCING ADAPTOR

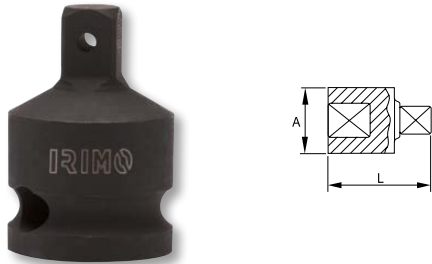

- 3/8" to 1/4" reducing adaptor
- Standards: DIN 16503, ISO 1174
- Due to the special working conditions of this adaptor, it is not guaranteed against male failure

R	Icon	A mm	L mm	g
162-65-1	1	19	28	57

3/8"-1/2" INCREASING ADAPTOR

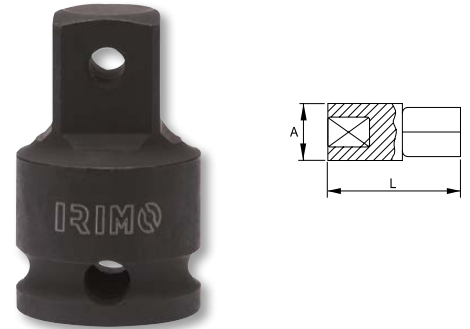

- 3/8" to 1/2" increasing adaptor
- Standards: DIN 16503, ISO 1174

R	Icon	A mm	L mm	g
162-60-1	1	22	36	96

SAFETY SPRINGS



- 3/8" safety rings

R	Icon	□	○	g
162931	1	3/8"	7-12	2
162941	1	3/8"	13-24	2

1/2" IMPACT SOCKETS

1/2" IMPACT HEXAGONAL SOCKETS, METRIC

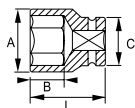

Standards: UNE 16507, ISO 2725, DIN 3129

Part No.	Box	Hex	A mm	B mm	C mm	L mm	g
167-08-1	1	8	15	15	25	38	84
167-10-1	1	10	17.5	15	25	38	89
167-12-1	1	12	19	15	25	38	94
167-13-1	1	13	20	15	25	38	94
167-14-1	1	14	22	15	25	38	94
167-15-1	1	15	23	15	25	38	134
167-16-1	1	16	24	15	25	38	134
167-17-1	1	17	26	15	30	38	134
167-18-1	1	18	27	15	30	38	134
167-19-1	1	19	28	17.5	30	38	134
167-20-1	1	20	29	17.5	30	38	137
167-21-1	1	21	30	17.5	30	38	149
167-22-1	1	22	32	17.5	30	38	149
167-23-1	1	23	34	18	30	40	149
167-24-1	1	24	34	18	30	40	179
167-26-1	1	26	36	22	30	42	189
167-27-1	1	27	38	22	30	42	204
167-30-1	1	30	42	22	30	44	234
167-32-1	1	32	44	22	40	44	282
167-34-1	1	34	46	22	40	48	406
167-36-1	1	36	48	22	40	48	467
167-38-1	1	38	50	23	40	48	480
167-41-1	1	41	50	24	42	48	495

1/2" IMPACT SOCKET RAIL SET



Part No.	Box	Case	Hex	g
167-91-2	1	5	17 - 19 - 22 - 24 - 27 mm	835
167-90-2	1	9	8 - 10 - 12 - 14 - 17 - 19 - 22 - 24 - 27 mm	1.180

1/2" IMPACT SOCKET SET



- Set 10 impact socket
- Strong blow moulded case
- Hex sockets
- Black finish
- Standards: ISO 2725, DIN 3129
- Plastic box in high density polyethylene

Part No.	Box	Case	Hex	g
167-10-4	1	10	200x160x52	1.425

167-10-1, 167-13-1, 167-14-1, 167-16-1, 167-17-1, 167-18-1, 167-19-1, 167-21-1, 167-22-1, 167-24-1



1/2" IMPACT SOCKETS

1/2" IMPACT HEXAGONAL SOCKETS, LONG SERIES, METRIC



R	Box	Hex	A mm	B mm	C mm	L mm	g
168-10-1	1	10	17.5	24	25	78	118
168-11-1	1	11	18	24	25	78	121
168-13-1	1	13	20	24	25	78	163
168-14-1	1	14	22	37	25	78	190
168-16-1	1	16	24	37	25	78	239
168-17-1	1	17	26	37	30	78	239
168-18-1	1	18	27	37	30	78	239
168-19-1	1	19	28	39	30	78	246
168-21-1	1	21	30	39	30	78	267
168-22-1	1	22	32	39	30	78	328
168-23-1	1	23	34	39	30	78	348
168-24-1	1	24	34	39	30	78	351
168-27-1	1	27	38	39	30	78	373
168-30-1	1	30	42	39	30	78	409
168-32-1	1	32	43	40	32	78	415

1/2" IMPACT SOCKET RAIL SET



R	Box	Hex	Length	g
168-90-2	1	7	10 - 13 - 17 - 19 - 22 - 24 - 27 mm	1.735

SAFETY SPRINGS



- 1/2" safety rings

R	Box	Hex	Hex	Length	g
169921	1	1/2"	10-14	5-10	2
169931	1	1/2"	15-36	12-19	2

1/2" IMPACT ACCESSORIES

1/2" EXTENSIONS



- Standards: DIN 16503, ISO 1174

R	Box	A mm	B mm	L mm	g
169-03-1	1	25	16.5	75	139
169-01-1	1	25	16.5	125	274
169-02-1	1	25	16.5	150	484

1/2"-3/4" INCREASING ADAPTOR

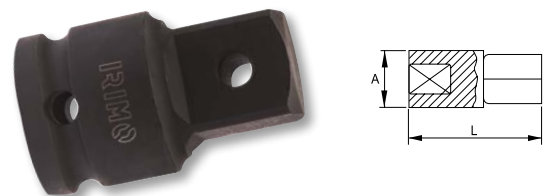

- 1/2" to 3/4" increasing adaptor
- Standards: DIN 16503, ISO 1174

R	Box	A mm	L mm	g
169-60-1	1	30	48	114

1/2"-3/8" REDUCING ADAPTOR



- 1/2" to 3/8" reducing adaptor
- Standards: ISO 1174, DIN 16503
- Due to the special working conditions of this adaptor, it is not guaranteed against male failure

R	Box	A mm	L mm	g
169-65-1	1	25	38	129

1/2" UNIVERSAL JOINT



- Standards: DIN 16503, ISO 1174

R	Box	A mm	L mm	g
169-25-1	1	30	63	189

3/4" IMPACT SOCKETS

3/4" IMPACT HEXAGONAL SOCKETS, METRIC

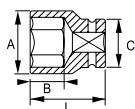

Standards: UNE 16507, ISO 2725, DIN 3129

Part No.	Box	Size	A mm	B mm	C mm	L mm	Weight (g)
173-17-2	1	17	30	21	44	51	339
173-18-2	1	18	32	21	44	51	339
173-19-2	1	19	33	21	44	51	349
173-21-2	1	21	35	21	44	51	359
173-22-2	1	22	36	21	44	51	359
173-23-2	1	23	37	21	44	51	369
173-24-2	1	24	38	21	44	51	379
173-27-2	1	27	41	21	44	51	399
173-28-2	1	28	42	23	44	51	409
173-29-2	1	29	45	23	44	51	409
173-30-2	1	30	46	23	44	51	439
173-32-2	1	32	48	27	44	57	469
173-33-2	1	33	50	27	44	57	489
173-34-2	1	34	51	27	44	57	509
173-36-2	1	36	53	27	44	57	519
173-38-2	1	38	56	27	44	57	559
173-41-2	1	41	59	28	44	58	659
173-46-2	1	46	66	30	44	62	709
173-50-2	1	50	71	32	54	65	839
173-55-2	1	55	77	37	54	70	1109
173-60-2	1	60	84	37	54	70	1200

3/4" IMPACT SOCKET SET, IN METAL BOX



Set in metal box

Part No.	Box	Quantity	Size	Weight (g)
173-01-5	1	8	24 - 27 - 29 - 30 - 32 - 34 - 36 - 38 mm	4.000

3/4" IMPACT HEXAGONAL SOCKETS, LONG SERIES, METRIC

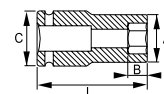

Part No.	Box	Size	A mm	B mm	C mm	L mm	Weight (g)
174-17-2	1	17	30	23	44	90	560
174-19-2	1	19	33	23	44	90	600
174-21-2	1	21	35	23	44	90	680
174-22-2	1	22	36	23	44	90	700
174-24-2	1	24	38	23	44	90	750
174-27-2	1	27	41	23	44	90	800
174-30-2	1	30	46	27	44	90	898
174-32-2	1	32	48	27	44	90	957
174-33-2	1	33	50	27	44	90	1010
174-34-2	1	34	51	27	44	90	1030
174-36-2	1	36	55	27	44	90	1084
174-41-2	1	41	59	28	44	90	1270

3/4" IMPACT ACCESSORIES

3/4" UNIVERSAL JOINT

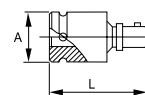

Standards: DIN 16503, ISO 1174

Part No.	Box	Size	L mm	Weight (g)
175-25-2	1	42	92	580

SAFETY SPRINGS

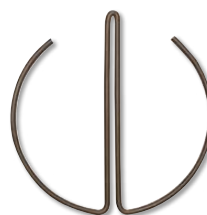

3/4" safety rings

Part No.	Box	Size	Length	Weight (g)
175911	1	3/4"	17-46	2
179931	1	3/4"	50-60	2

3/4" IMPACT ACCESSORIES

3/4" EXTENSIONS

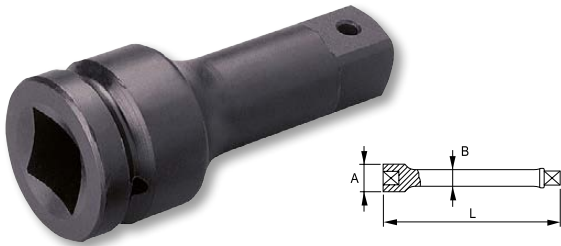

- Standards: DIN 16503, ISO 1174

R	Box	A mm	B mm	L mm	g
175-01-2	1	175	44	21	850
175-10-2	1	250	44	21	1.190
175-02-2	1	325	44	21	1.460

3/4"-1" INCREASING ADAPTOR



- 3/4" to 1" increasing adaptor
- Standards: DIN 16503, ISO 1174

R	Box	A mm	L mm	g
175-60-2	1	44	63	410

3/4"-1/2" REDUCING ADAPTOR



- 3/4" to 1/2" reducing adaptor
- Standards: DIN 16503, ISO 1174
- Due to the special working conditions of this adaptor, it is not guaranteed against male failure

R	Box	A mm	L mm	g
175-65-2	1	44	57	350

1" IMPACT SOCKETS

1" IMPACT HEXAGONAL SOCKETS, METRIC



- Standards: UNE 16507, ISO 2725, DIN 3129

R	Box	Hex	A mm	B mm	C mm	L mm	g
177-22-2	1	22	39	22	54	58	645
177-24-2	1	24	41	22	54	58	650
177-27-2	1	27	46	22	54	58	670
177-30-2	1	30	49	24	54	62	680
177-32-2	1	32	52	24	54	62	695
177-33-2	1	33	54	24	54	62	695
177-34-2	1	34	54	24	54	62	720
177-36-2	1	36	56	29	54	65	800
177-38-2	1	38	58	29	54	65	845
177-41-2	1	41	61	34	54	70	920
177-42-2	1	42	64	34	54	70	950
177-46-2	1	46	68	36	54	75	1150
177-50-2	1	50	73	36	54	75	1375
177-55-2	1	55	79	44	54	83	1540
177-60-2	1	60	86	47	54	87	1700
177-65-2	1	65	92	47	54	90	1940
177-70-2	1	70	97	47	54	93	2450
177-75-2	1	75	104	47	86	95	2900
177-80-2	1	80	110	39	86	100	3300

1" IMPACT SOCKET SET, IN METAL BOX



- Set in metal box

R	Box	X	Socket	g
177-10-5	1	7	24 - 27 - 30 - 32 - 33 - 36 - 38 mm	5.500

1" IMPACT HEXAGONAL SOCKETS, LONG SERIES, METRIC

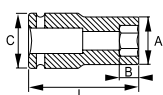

Q			A mm	B mm	C mm	L mm	g
178-22-2	1	22	39	23	54	90	975
178-24-2	1	24	42	23	54	90	1016
178-27-2	1	27	46	23	54	90	1134
178-30-2	1	30	49	24	54	90	1256
178-32-2	1	32	52	24	54	90	1297
178-33-2	1	33	54	24	54	92	1311
178-34-2	1	34	54	24	54	92	1350
178-36-2	1	36	56	29	54	92	1474
178-38-2	1	38	58	29	54	92	1479
178-41-2	1	41	61	34	54	92	1533
178-46-2	1	46	68	36	54	95	1710
178-50-2	1	50	73	36	54	95	1896
178-55-2	1	55	79	44	54	100	2155
178-60-2	1	60	86	47	54	100	2372

1" IMPACT ACCESSORIES

1" EXTENSIONS

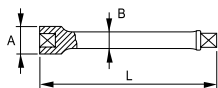

- Standards: DIN 16503, ISO 1174

Q		A mm	B mm	L mm	g
179-00-2	1	125	54	34	1.085
179-01-2	1	175	54	34	1.390
179-02-2	1	325	54	34	2.395

SAFETY SPRINGS

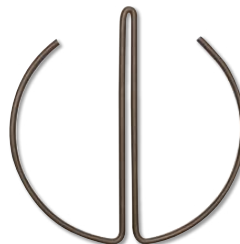

- 1" safety rings

Q					g
179931	1	1"	19-70	17-27	9
179941	1	1"	75-80		13

1"-3/4" REDUCING ADAPTOR

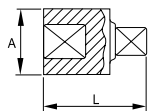

- 1" to 3/4" reducing adaptor
- Standards: DIN 16503, ISO 1174
- Due to the special working conditions of this adaptor, it is not guaranteed against male failure

Q		A mm	L mm	g
179-65-2	1	54	70	350

1" UNIVERSAL JOINT

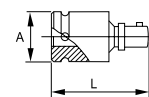

- Standards: DIN 16503, ISO 1174

Q		A mm	L mm	g
179-52-2	1	54	120	650



A close-up photograph of a wooden frame being assembled on a workbench. The frame consists of several light-colored wooden planks joined together. Several blue clamps are used to hold the pieces in place. In the foreground, a black clamp with the brand name 'OMISI' is visible. The background shows a white workbench with some faint markings and a square tool.

05. CLAMPING TOOLS

BENCH VICES

ROUND GUIDE VICE

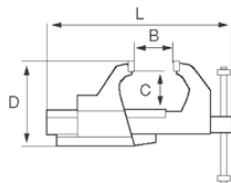

- Round guide bench vice
- Heavy duty
- Manufactured by high grade cast steel
- Interchangeable jaws
- Oversized anvil
- Laminated spindle thread
- Smooth operation
- Can be used with swivel base

R			B mm	C mm	D mm	L mm	g
201231	1	80	90	42	130	260	5.850
201241	1	100	110	56	166	325	11.350
201251	1	125	130	72	196	375	18.200
201261	1	150	170	80	230	430	29.700

SQUARE GUIDE VICE



- Heavy duty square guide bench vice
- Manufactured from high grade cast steel
- Interchangeable jaws
- Oversized anvil
- Laminated spindle thread for smooth operation
- Can be used with swivel base
- Free play adjustment via screw mechanism
- With pipe holding jaws

R			B mm	C mm	D mm	L mm	g
216041	1	100	145	50	122	325	6.497
216051	1	125	170	63	152	402	13.733
216061	1	150	230	80	182	492	20.388
216071	1	175	250	94	211	551	30.688

SQUARE GUIDE VICE

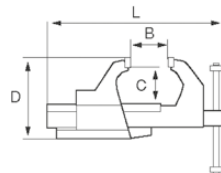

- Heavy duty square guide bench vice
- Manufactured from high grade cast steel
- Oversized anvil
- Interchangeable jaws are available
- Laminated spindle thread for smooth operation
- Can be used with swivel base

R			B mm	C mm	D mm	L mm	g
207041	1	100	145	50	122	325	6.200
207051	1	125	170	63	152	402	13.200
207061	1	150	230	80	182	492	19.800
207071	1	175	250	94	211	551	30.100

SQUARE GUIDE VICE

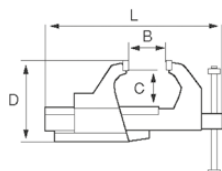

- Heavy duty square guide bench vice
- Manufactured from ductile iron, with similar characteristics to steel
- High impact resistance and durability
- Fitted with swivel base
- Large square anvil
- Added a stop pin at the main screw end to prevent jaw from falling out
- Spare jaws and spindle available
- GS certification

Q	Icon	Icon	B mm	C mm	D mm	L mm	g
207-100	1	100	100	61	164	330	11.450
207-125	1	125	125	72	193	408	20.000
207-150	1	150	150	84	223	466	29.700

SPARE PARTS FOR BENCH VICES

SPARE JAWS

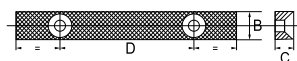

- Pair of spare jaws and screws for round guide vice 201

Q	Icon	Icon	B mm	C mm	D mm	g
202401	1	80	15	10	55	170
202411	1	100	20	12	64	350
202421	1	125	20	12	77	450
202431	1	150	25	14	90	750

SPARE JAWS

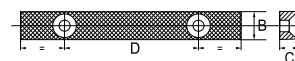

- Pair of spare jaws and screws for square guide vices 207041 / 207071 and 216

Q	Icon	Icon	B mm	C mm	D mm	g
202441	1	100	15	10	64	350
202421	1	125	20	12	77	450
202451	1	150	20	12	90	750
202461	1	175	25	14	105	1.020

SPARE JAWS

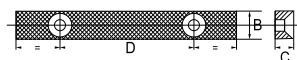
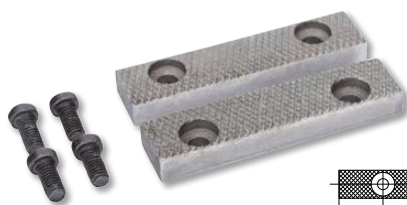

- Pair of spare jaws and screws for square guide vices 207-100 / 207-150

Q	Icon	Icon	B mm	C mm	D mm	g
202-100	1	100	20	10	60	270
202-125	1	125	21	12	75	460
202-150	1	150	21	12	90	550

PAIR OF PIPE JAWS AND SCREWS



- Pair of pipe jaws and screws for square guide vices 207041 / 207071 and 216

Q	Icon	Icon	Icon	Icon	Icon	g
206721	1	100	13.5 - 26.9			245
206741	1	125	21.3 - 76.1			436
206761	1	150 / 175	26.9 - 89.0			478



SPARE PARTS FOR BENCH VICES

SPARE SPINDLE AND BOLT



- Spare spindle and bolt for round guide vice 201

R				
		mm	mm	g
202811	1	80	251	875
202821	1	100	317	1.400
202831	1	125	364	2.200
202841	1	150	428	3.400

SPARE SPINDLE AND NUT



SPARE SPINDLE AND NUT



- Spare spindle and nut for square guide vice 207041 / 207071 and 216

R				
		mm	mm	g
206821	1	100	287	600
206831	1	125	352	1.400
206841	1	150	432	2.200
206851	1	175	471	3.200

ACCESSORIES FOR BENCH VICES

ALUMINIUM JAWS

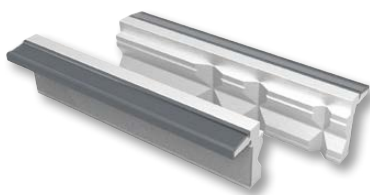

- Prism jaws of hardened aluminium
- Offer efficient clamping and protection of the workpiece at the same time
- Designed for horizontal clamping of flat and round objects
- Designed for vertical clamping of round objects
- 90° recess in the top to hold flat bar stock while marking out or centrepunching
- Horizontal vee-groove with an angle of 120° for clamping of pipes and other round workpieces
- 3 vertical vee-grooves with angles of 100°, 120° and 130° for clamping of pipes and other round workpieces
- Excellent powerful neodymium magnetic strip

R			
		mm	g
202561	1	100	180
202571	1	125	200
202581	1	150	220

ALUMINIUM JAWS



- Neutral jaws of hardened aluminium
- For clamping rough or medium finish, machined workpieces
- Impact resistant extruded polycarbonate PC
- Hardened aluminium offers superior corrosion resistance along with excellent surface finish
- Excellent powerful neodymium magnetic strip

R			
		mm	g
202511	1	100	180
202521	1	125	200
202541	1	150	220

POLYURETHANE JAWS

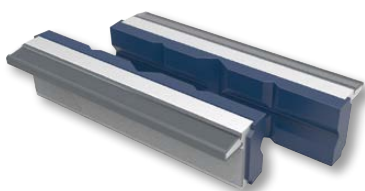

- Polyurethane jaws with grooves
- For clamping of round parts with very delicate details
- The jaws are manufactured from the special flexible polyurethane material
- Shore hardness A82
- Polyurethane is known for its unique abilities to “bite onto” the work piece without damaging or scratching it
- Polyurethane is so flexible, that it returns to its original shape after deformation
- Excellent powerful neodymium magnetic strip

E			g
202661	1	100	150
202671	1	125	175
202681	1	150	200

POLYURETHANE JAWS

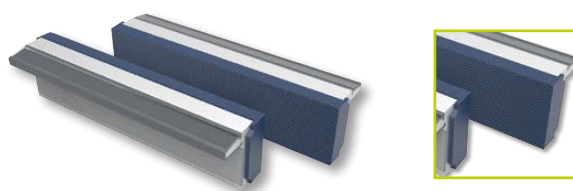

- Polyurethane jaws with small cross serrations
- For clamping of flat parts with very delicate details
- The jaws are manufactured from the special flexible polyurethane material
- Shore hardness A82
- Polyurethane is known for its unique abilities to “bite onto” the work piece without damaging or scratching it
- Polyurethane is so flexible, that it returns to its original shape after deformation
- Excellent powerful neodymium magnetic strip

E			g
202761	1	100	150
202771	1	125	175
202781	1	150	200

SWIVEL VICE BASE



- Swivel base for all round 201 and 207041 / 207071 square guide vice models
- Manufactured from high grade cast steel

E		Ø mm		L mm	d mm	g
201431	1	80	100	90	11	850
201451	1	100	125	115	13	1.150
201461	1	125	150	145	13	1.500
201471	1	150	175	165	17	2.500

TABLE VICE

MINI BENCH VICE

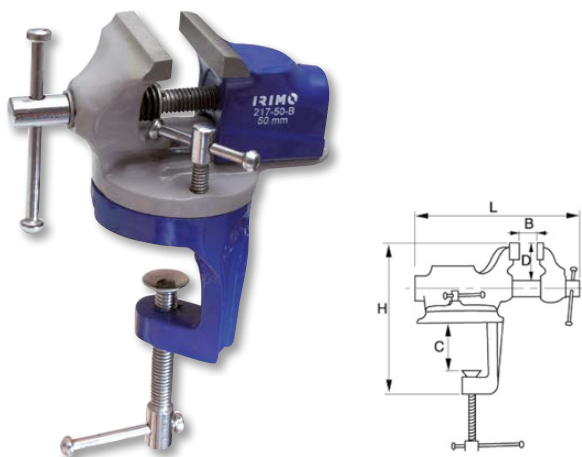

- Versatile tool for filing, flattening or laying out work
- With swivel base
- Finished anvil
- Material: cast iron
- Blister packaging

E			B mm	C mm	D mm	H mm	L mm	g
217-50-B	1	50	40	34	20	120	125	1.100



SCREW CLAMPS

FORGED WOODEN HANDLE F-CLAMP



- Professional type F clamp with one fixed and one sliding bracket fitted to a galvanised profiled steel rail
- Screwed wooden handle for a comfortable adjusting
- Forged jaws allows a high and maintained clamping force

R		A mm	B mm	HxS mm	g
258-100-2	1	60	100	15.5x7.5	450
258-120-2	1	60	120	15.5x7.5	750
258-160-2	1	80	160	15.5x7.5	900
258-200-2	10	120	200	22x10.6	1.200
258-250-2	10	120	250	22x10.6	1.500
258-300-2	10	120	300	22x10.6	1.586

STEEL CLAMP, 90 MM



R		A mm	B mm	HxS mm	g
256001	5	150	90	30x8	1.100
256011	5	200	90	30x8	1.200
256031	5	300	90	30x8	1.400
256041	5	400	90	30x8	1.600

STEEL T-HANDLE CLAMP, 120 MM

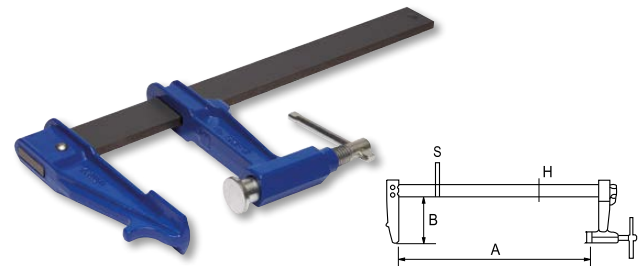

R		A mm	B mm	HxS mm	g
256131	5	300	120	35x8	2.000
256141	5	400	120	35x8	2.200
256151	5	500	120	35x8	2.400
256161	5	600	120	35x8	2.600
256181	5	800	120	35x8	3.000
256201	5	1.000	120	35x8	3.400

NON-SLIP BRAKING MECHANISM CLAMP, 150 MM

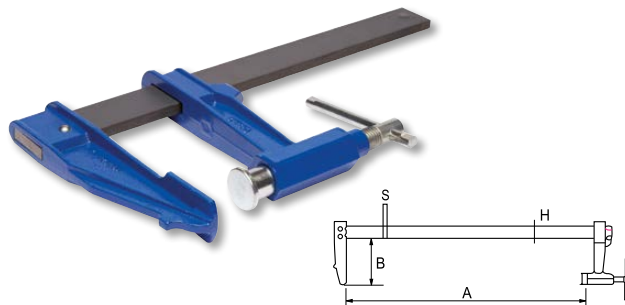

R		A mm	B mm	HxS mm	g
256231	5	300	150	40x10	3.100
256241	5	400	150	40x10	3.400
256251	2	500	150	40x10	3.700
256261	2	600	150	40x10	4.000
256281	2	800	150	40x10	4.600
256301	2	1.000	150	40x10	5.200
256321	1	1.200	150	40x10	5.800

LIGHT SCREW CLAMP, 70 MM

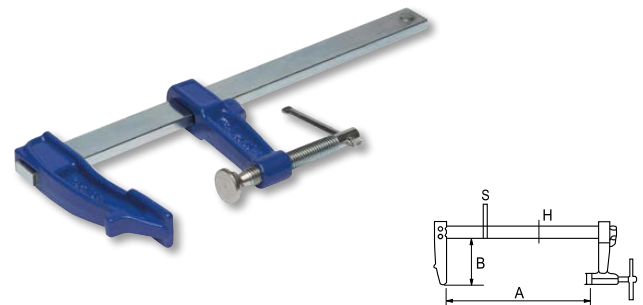

R		A mm	B mm	HxS mm	g
255011	10	120	70	18x7	420
255021	10	150	70	18x7	450
255031	10	200	70	18x7	500
255041	10	250	70	18x7	550
255051	10	300	70	18x7	600

FORGED RATCHETING F-CLAMP

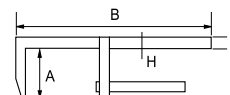

- Professional clamp
- Strong Clamping tool
- Aluminium body
- Up to 5100 Nw
- Ratcheting system to facilitate adjust and clamping

Q		B mm	A mm	HxS mm	
257-200-2	10	200	140	25x12	986
257-300-2	10	300	140	25x12	1.586
257-400-2	10	400	140	25x12	2.286
257-500-2	10	500	140	25x12	2.886
257-600-2	10	600	140	25x12	3.286

QUICK CLAMPS

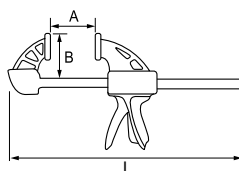

- High resistance clamps with quick release system
- Clamping capacity over 60 kg
- Reversible jaw mechanism



Q		A mm	B mm	L mm	
254-150-2	1	150 - 6"	60	335	487
254-300-2	6	300 - 12"	60	485	586
254-450-2	6	450 - 18"	60	635	686
254-600-2	6	600 - 24"	60	785	781
254-900-2	6	900 - 36"	60	1.085	980
254-1200-2	4	1.200 - 48"	60	1.685	1.165



06. PIPE TOOLS

STILLSON WRENCHES

STILLSON WRENCH

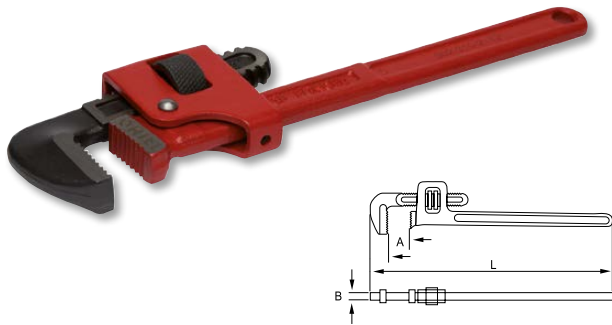

- Forged template steel
- Hardened gripping teeth 55-60 HRC
- Epoxy painting

R	Icon	A inch	A mm	B mm	L inch	L mm	g
302-210-2	3	1"	19	11	8"	210	290
302-260-2	3	1.3/8"	25	15	10"	260	620
302-310-2	3	1.3/4"	26	17	12"	310	800
302-365-2	3	2"	28	19	14"	365	1.120
302-465-2	1	2.3/8"	30	23	18"	465	1.890
302-615-2	1	3"	39	26	24"	615	3.200
302-900-2	1	4"	48	30	36"	900	6.100

STILLSON ALUMINIUM WRENCH

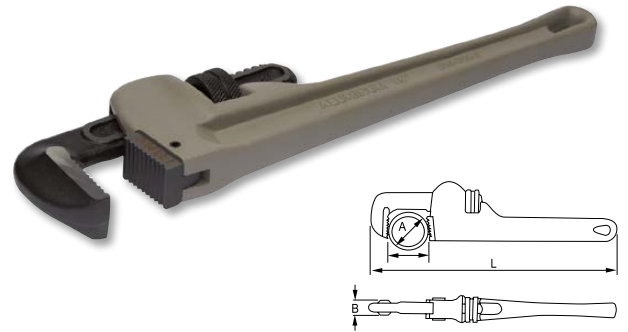

- Aluminium alloy handle with section in double T
- Light, 40% less weight and great resistance

R	Icon	A inch	A mm	B mm	L inch	L mm	g
304-250-2	2	1.1/2"	22	17	10"	250	430
304-350-2	2	2"	26	21	14"	350	950
304-450-2	1	2.1/2"	29	26	18"	450	1.650
304-600-2	1	3"	33	28	24"	600	2.500
304-900-2	1	5"	44	32	36"	900	5.200

SPARE PARTS FOR STILLSON WRENCHES



R	R	Icon	L inch
302S-210-2	302T-210-2	1	8"
302S-260-2	302T-260-2	1	10"
302S-310-2	302T-310-2	1	12"
302S-365-2	302T-365-2	1	14"
302S-465-2	302T-465-2	1	18"
302S-615-2	302T-615-2	1	24"
302S-900-2	302T-900-2	1	36"

SPARE PARTS FOR STILLSON ALUMINIUM WRENCH



R	R	R	Icon	L inch
304S-250-2	304T-250-2	304F-250-2	1	10"
304S-350-2	304T-350-2	304F-350-2	1	14"
304S-450-2	304T-450-2	304F-450-2	1	18"
304S-600-2	304T-600-2	304F-600-2	1	24"
304S-900-2	304T-900-2	304F-900-2	1	36"

CHAIN PIPE WRENCH

CHAIN PIPE WRENCH



- Strong chain made of tempered special steel
- Jaws and body in forged hardened steel
- Double sided tooth system for ratchet-like use
- Self locking function in both directions

E	S	A mm	B mm	L mm	g	
307-350-2	1	1.1/2"	8	38	350	1.400
307-685-2	1	2.1/2"	9	79	685	3.500
307-940-2	1	4"	13	60	940	6.700
307-1122-2	1	6"	20	75	1.122	12.600

SPARE CHAIN



- Material: tempered special steel

E	S	g	
307S-350-2	1	307-350-2	340
307S-685-2	1	307-685-2	475
307S-940-2	1	307-940-2	560
307S-1122-2	1	307-1122-2	830

PIPE WRENCHES SWEDISH MODEL

CORNER MOUTH

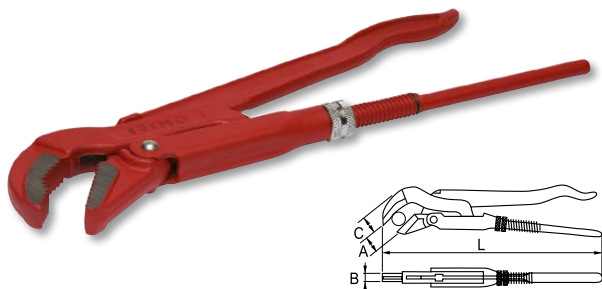

- Forged steel
- Epoxy painting
- Hardened gripping teeth

E	A inch	A mm	C mm	B mm	L mm	g	
303081	1	1/2"	15	20	8	240	665
303111	1	1"	25	25	11	315	1.145
303121	1	1.1/2"	40	27	12	425	1.890
303131	1	2"	50	30	13	550	3.275
303171	1	3"	80	36	17	655	6.425

PERPENDICULAR MOUTH

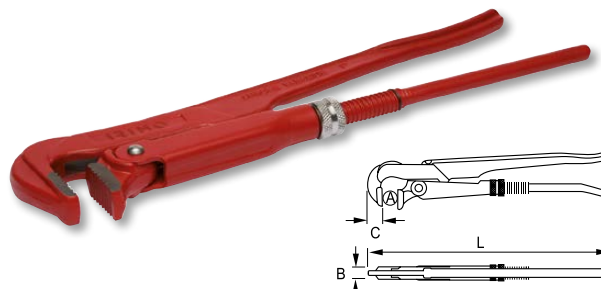

- Forged steel
- Epoxy painting
- Hardened gripping teeth

E	A inch	A mm	C mm	B mm	L mm	g	
303201	1	1"	25	16	18	320	800
303211	1	1.1/2"	40	19	20	425	1.300
303221	1	2"	50	21	25	560	2.300
303231	1	3"	80	22	30	630	2.900
303241	1	4"	117	30	32	735	5.900

CURVED MOUTH

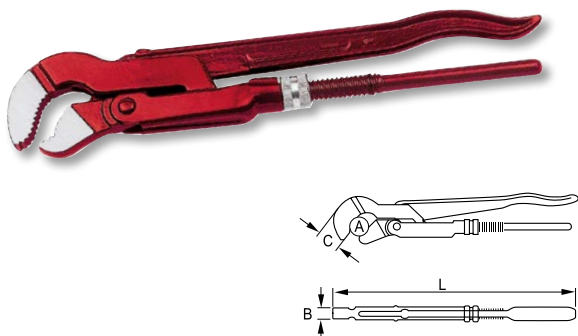

- Forged steel
- Epoxy painting
- Hardened gripping teeth

E	A inch	A mm	C mm	B mm	L mm	g	
303291	1	1/2"	15	13	16	235	400
303301	1	1"	25	17	23	330	800
303311	1	1.1/2"	40	19	27	420	1.400
303321	1	2"	50	21	32	535	2.400
303331	1	3"	80	24	34	648	4.200



PIPE CUTTERS

SMALL COPPER PIPE CUTTER



- Enamelled
- Phosphated finish

Q	Icon	S	Ø mm	L mm	g
321161	2	1/8" - 5/8"	3 - 16	58	122
321171	2	1/8" - 1.1/8"	3 - 30	80	220

MULTIPURPOSE PIPE CUTTER

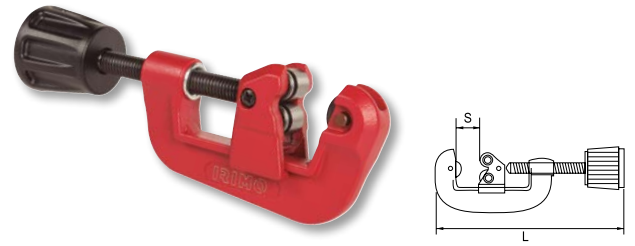

- Enamelled
- Phosphated finish

Q	Icon	S	Ø mm	L mm	g
321281	1	1/8" - 1.1/8"	3 - 30	30	321

TELESCOPIC COPPER PIPE CUTTER



- Enamelled
- Phosphated finish

Q	Icon	S	Ø mm	L mm	g
321361	1	1/8" - 1.3/8"	3 - 35	160	330

STEEL PIPE CUTTER

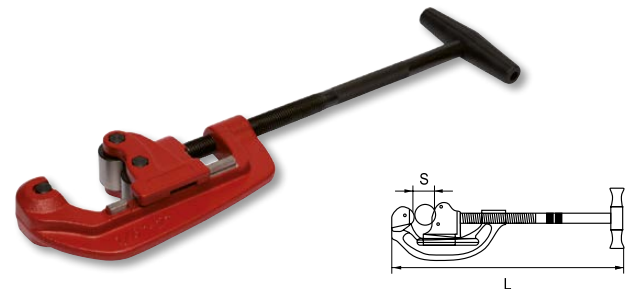

- Enamelled
- Phosphated finish

Q	Icon	S	Ø mm	L mm	g
321501	1	1/8" - 2"	3 - 50	385	2.520

SPARE WHEELS



Q	Icon	D mm	d mm	E mm	g		
321511	1	321161 / 321171 / 321281 / 321321 / 321351 / 321361		20	5	5	5
321551	1	321501		31	9	19	28

AUTO RETRACT PLASTIC TUBE CUTTER



- From 6 to 42 mm
- Used for PVC, CPVC, POLY, PEX & PE tube materials
- Retail packaging

Q	Icon	L mm	g
321-42-1	12	205	680

SPARE BLADE



- Spare blade for 312-42-1 Plastic tube cutter
- Retail packaging

Q	Icon	g
321-BLADE-1	25	58

GASKET CUTTERS

GASKET CUTTERS SET



332-51-4	1	11	140 x 130 x 40	680

333-003-2, 333-004-2, 333-006-2, 333-008-2, 333-010-2, 333-012-2, 333-014-2, 333-016-2, 333-018-2, 333-020-2
332S-030-2

GASKET CUTTERS SET



332-52-4	1	16	140 x 130 x 40	680

333-003-2, 333-004-2, 333-006-2, 333-008-2, 333-010-2, 333-012-2, 333-014-2, 333-016-2, 333-018-2, 333-020-2, 333-022-2, 333-024-2, 333-026-2, 333-028-2, 333-030-2
332S-030-2

GASKET CUTTERS

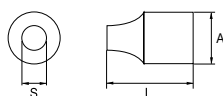

- Interchangeable gasket washer cutters
- Cuts all gasket materials: leather, rubber, cardboard, fibre, asbestos, lead, felt, plastic, etc.
- Triple shapening: inside, outside and cutting edge
- Atmosphere protected tempered alloy steel punches

		S mm		A mm	L mm	
333-003-2	1	3	1/2 x 24 Z"	14	31	15
333-004-2	1	4	1/2 x 24 Z"	14	31	15
333-006-2	1	6	1/2 x 24 Z"	14	31	15
333-008-2	1	8	1/2 x 24 Z"	14	31	15
333-010-2	1	10	1/2 x 24 Z"	14	31	15
333-012-2	1	12	Flat	25	30	30
333-014-2	1	14	Flat	25	30	30
333-016-2	1	16	Flat	25	30	30
333-018-2	1	18	Flat	25	30	30
333-020-2	1	20	Flat	25	30	30
333-022-2	1	22	Flat	35	35	50
333-024-2	1	24	Flat	35	35	50
333-026-2	1	26	Flat	35	35	50
333-028-2	1	28	Flat	35	35	50
333-030-2	1	30	Flat	35	35	50

WAD PUNCHES 3 - 30 HANDLE



332S-030-2	1	003-030 mm	350

REVOLVER WAD PUNCHES

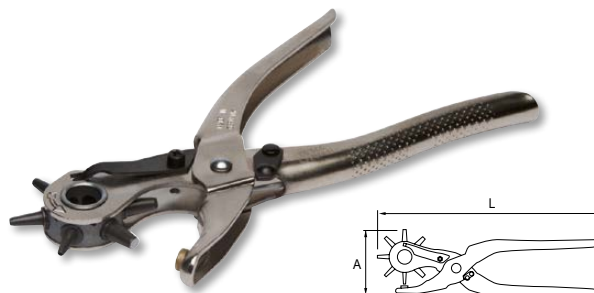

- Rotating wheel for 6 punching sizes in leather, rubber, plastic, canvas, joints and other similar material
- Easy selection and diameter hole vision to avoid errors
- Its exclusive design reduces necessary force in a 70%

		S	\emptyset mm	L mm	
330021	1	1/8" - 2"	3 - 50	385	2.520



07. SCREWDRIVERS & BITS

SCREWDRIVERS

SLOTTED SCREWDRIVERS FOR ENGINEERS



- 2-component handle with hanging hole
- Blade is made of high performance alloy steel, CrV. Chrome-plated and entirely hardened. Vapour blasted tip for greater screw-tip adherence and full anti-rust guarantee
- Size and part number are laser branded on the blade for easy identification
- Standard: ISO 2380, DIN 5265, UNE 16516

Part No.	Blade Width (mm)	Blade Length (mm)	Blade Thickness (mm)	Blade Height (mm)	Blade Width (mm)	Blade Length (mm)	Weight (g)
407-4-75	10	0.8	4	75	90	165	40
407-4-100	10	0.8	4	100	90	190	40
407-5.5-100	10	1	5.5	100	100	200	65
407-5.5-125	10	1	5.5	125	100	225	70
407-6.5-125	10	1.2	6.5	125	110	235	100
407-6.5-150	10	1.2	6.5	150	110	260	105
407-8-150	10	1.6	8	150	110	260	119
407-8-175	10	1.6	8	175	110	285	127
407-10-200	10	1.6	10	200	120	320	175
407-12-250	5	2	12	250	120	370	230
407-14-250	5	2.5	14	250	120	370	260

SLOTTED SCREWDRIVERS FOR ELECTRICIANS



- 2-component handle with hanging hole
- Blade is made of high performance alloy steel, CrV. Chrome-plated and entirely hardened. Vapour blasted tip for greater screw-tip adherence and full anti-rust guarantee
- Size and part number are laser branded on the blade for easy identification
- Standard: ISO 2380, DIN 5265, UNE 16516

Part No.	Blade Width (mm)	Blade Length (mm)	Blade Thickness (mm)	Blade Height (mm)	Blade Width (mm)	Blade Length (mm)	Weight (g)
408-2.5-75	10	0.4	2.5	75	90	165	34
408-3-75	10	0.5	3	75	90	165	35
408-3-100	10	0.5	3	100	90	190	40
408-3-200	5	0.5	3	200	90	290	45
408-3.5-100	10	0.6	3.5	100	90	190	40
408-4-100	10	0.8	4	100	90	190	45
408-4-125	10	0.8	4	125	90	215	45
408-4-250	5	0.8	4	250	90	340	60
408-5.5-125	10	1	5.5	125	100	225	65
408-5.5-150	10	1	5.5	150	100	250	90
408-5.5-300	5	1	5	300	100	400	106
408-6.5-150	10	1.2	6.5	150	110	260	110

STUBBY SLOTTED SCREWDRIVERS



- 2-component handle with hanging hole
- Blade is made of high performance alloy steel, CrV. Chrome-plated and entirely hardened. Vapour blasted tip for greater screw-tip adherence and full anti-rust guarantee
- Standard: ISO 2380, DIN 5265, UNE 16516

Part No.	Blade Width (mm)	Blade Length (mm)	Blade Thickness (mm)	Blade Height (mm)	Blade Width (mm)	Blade Length (mm)	Weight (g)
408-5.5-25	10	1.2	5.0	25	60	85	35
408-6.5-25	10	1.2	6.0	25	60	85	35

PHILLIPS SCREWDRIVERS



- 2-component handle with hanging hole
- Blade is made of high performance alloy steel, CrV. Chrome-plated and entirely hardened. Vapour blasted tip for greater screw-tip adherence and full anti-rust guarantee
- Size and part number are laser branded on the blade for easy identification
- Standard: ISO 8764, DIN 5262, UNE 16520

Part No.	Blade Length (mm)	Tip Length (mm)	Blade Width (mm)	Blade Thickness (mm)	Weight (g)	
409-0-75	10	PH-0	75	90	165	35
409-1-100	10	PH-1	100	100	200	65
409-2-125	10	PH-2	125	110	235	100
409-3-150	5	PH-3	150	120	270	160
409-4-200	5	PH-4	200	120	320	200
409-1-250	5	PH-1	250	100	350	89
409-2-300	5	PH-2	300	110	410	130

STUBBY PHILLIPS SCREWDRIVERS



- 2-component handle with hanging hole
- Blade is made of high performance alloy steel, CrV. Chrome-plated and entirely hardened. Vapour blasted tip for greater screw-tip adherence and full anti-rust guarantee
- Standard: ISO 8764, DIN 5262, UNE 16520

Part No.	Blade Length (mm)	Tip Length (mm)	Blade Width (mm)	Blade Thickness (mm)	Weight (g)	
409-1-25	10	PH-1	25	60	85	35
409-2-25	10	PH-2	25	60	85	35

POZIDRIV SCREWDRIVERS



- 2-component handle with hanging hole
- Blade is made of high performance alloy steel, CrV. Chrome-plated and entirely hardened. Vapour blasted tip for greater screw-tip adherence and full anti-rust guarantee
- Size and part number are laser branded on the blade for easy identification
- Standard: ISO 8764, DIN 5262, UNE 16520

Part No.	Blade Length (mm)	Tip Length (mm)	Blade Width (mm)	Blade Thickness (mm)	Weight (g)	
413-0-75	5	PZ-0	75	90	165	35
413-1-100	5	PZ-1	100	100	200	75
413-2-125	5	PZ-2	125	110	235	100
413-3-150	5	PZ-3	150	120	270	160
413-4-200	5	PZ-4	200	120	270	205

STUBBY POZIDRIV SCREWDRIVERS



- 2-component handle with hanging hole
- Blade is made of high performance alloy steel, CrV. Chrome-plated and entirely hardened. Vapour blasted tip for greater screw-tip adherence and full anti-rust guarantee
- Standard: ISO 8764, DIN 5262, UNE 16520

Part No.	Blade Length (mm)	Tip Length (mm)	Blade Width (mm)	Blade Thickness (mm)	Weight (g)	
413-1-25	10	PZ-1	25	60	85	35
413-2-25	10	PZ-2	25	60	85	35



SCREWDRIVERS

TORX® SCREWDRIVERS



- 2-component handle with hanging hole
- Blade is made of high performance alloy steel, CrV. Chrome-plated and entirely hardened. Black finish tip for higher accuracy
- Size and part number are laser branded on the blade for easy identification

Part No.	Box	Icon	Tip Size (mm)	Blade Length (mm)	Shaft Length (mm)	Total Length (mm)	Weight (g)
414-5-75	10	T-5	2.5	75	90	165	32
414-6-75	10	T-6	3	75	90	165	35
414-7-75	10	T-7	3	75	90	165	35
414-8-75	10	T-8	3	75	90	165	35
414-9-75	10	T-9	3	75	90	165	35
414-10-75	10	T-10	3	75	90	165	35
414-15-100	10	T-15	3.5	100	90	190	45
414-20-100	10	T-20	4	100	90	190	45
414-25-125	10	T-25	5	125	100	225	70
414-27-125	10	T-27	5.5	125	100	225	70
414-30-150	10	T-30	6	150	110	260	105
414-40-150	5	T-40	7	150	110	260	120
414-45-150	5	T-45	7	150	110	260	120

NUT DRIVER WITH HANDLE 1/4"



- 2-component handle with hanging hole
- Blade is made of high performance alloy steel, CrV. Chrome-plated and entirely hardened
- Size and part number are laser branded on the blade for easy identification
- Standard: ISO 691, DIN 3125, UNE 16502

Part No.	Box	Icon	Tip Size (mm)	Blade Length (mm)	Shaft Length (mm)	Total Length (mm)	Weight (g)
417-3.2-125	5	3.2	5.7	125	90	215	60
417-4-125	5	4	6.9	125	90	215	60
417-4.5-125	5	4.5	7.5	125	90	215	60
417-5-125	5	5	8.2	125	100	250	70
417-5.5-125	5	5.5	8.8	125	100	250	70
417-6-125	5	6	9.4	125	100	250	70
417-7-125	5	7	11.0	125	110	260	120
417-8-125	5	8	12.2	125	110	260	120
417-9-125	5	9	13.5	125	110	260	120
417-10-125	5	10	14.7	125	110	260	120
417-11-125	5	11	16.0	125	120	270	155
417-12-125	5	12	17.2	125	120	270	155
417-13-125	5	13	18.5	125	120	270	155
417-14-125	5	14	19.7	125	120	270	155

MAGNETIC BIT HOLDER FOR 1/4" BITS



- 2-component handle with hanging hole
- Blade is made of high performance alloy steel, CrV
- Strong magnet
- Size and part number are laser branded on the blade for easy identification

Part No.	Box	Icon	Tip Size (mm)	Blade Length (mm)	Total Length (mm)	Weight (g)
475-1/4-125	5	1/4"	125	235	112	

FLEXIBLE BLADE BIT HOLDER FOR 1/4" BITS



- 2-component handle with hanging hole
- Blade is made of high performance alloy steel, CrV
- Flexible blade
- With retaining ring

Part No.	Box	Icon	Tip Size (mm)	Blade Length (mm)	Total Length (mm)	Weight (g)
475-1/4F-160	5	1/4"	160	270	135	

NUT DRIVER WITH HANDLE, WITH FLEXIBLE BLADE 1/4"



- 2-component handle with hanging hole
- Blade is made of high performance alloy steel, CrV
- Flexible blade

Part No.	Pkg	Blade Dia (mm)	Blade L (mm)	Total L (mm)	Weight (g)
190-6-135	1	6	135	260	125
190-7-135	1	7	135	270	125
190-8-135	1	8	135	270	125
190-10-135	1	10	135	270	125

RATCHETING BIT HOLDER FOR 1/4" BITS

RATCHETING BIT HOLDER SCREWDRIVER FOR 1/4" BITS



- Handle: 2-component handle
- Interchangeable bit storage compartment with release button for quick access
- Slide tray that keeps 12 different bits: Slotted 4, 5, 6 mm; PH 1, 2, 3; TORX® 15, 20, 25; Hex 3, 4, 5 mm
- Magnetic blade secures bit in screwdriver
- Smooth ratcheting stroke
- Three position ratchet mechanism: forward, reverse and neutral

Part No.	Pkg	Blade Dia (mm)	Blade L (mm)	Total L (mm)	Weight (g)	
475R-1/4-110	6	1/4"	110	125	235	310

RATCHETING BIT HOLDER STUBBY FOR 1/4" BITS



- Ratcheting bit holder stubby for 1/4" bits
- Handle: 2-component handle
- Interchangeable bit storage
- 6 double ended bits: Slotted 5.0, 6.0; PH1, PH2; T15, T20, T25, T30; Hex 2.5, 3, 4, 5 mm
- Magnetic blade secures bit in screwdriver
- Smooth ratcheting stroke, three position ratchet mechanism
- Presented in a blister packaging

Part No.	Pkg	Blade Dia (mm)	Blade L (mm)	Total L (mm)	Weight (g)	
475R-1/4-30	6	1/4"	30	80	110	192



INSULATED SCREWDRIVER, 1000V

SLOTTED INSULATED 1000V SCREWDRIVERS



- For work on live equipment, up to 1000V
- 2-component handle with hanging hole
- Blade is made of high performance alloy steel, insulation moulded directly onto blade. Black finish tip for higher accuracy
- Size and part number are laser branded on the blade for easy identification
- Standard: ISO 2380

R	mm	mm	mm	mm	mm	mm	g
408V-2.5-100	10	0.4	2.5	100	90	165	20
408V-3-100	10	0.5	3	100	90	190	22
408V-3.5-100	10	0.6	3.5	100	90	190	32
408V-4-100	10	0.8	4	100	90	190	35
408V-5.5-125	10	1	5.5	125	100	225	65
408V-6.5-150	10	1.2	6.5	150	110	260	90
408V-8-175	5	1.2	8	175	120	295	110

PHILLIPS INSULATED 1000V SCREWDRIVERS



- For work on live equipment, up to 1000V
- 2-component handle with hanging hole
- Blade is made of high performance alloy steel, insulation moulded directly onto blade. Black finish tip for higher accuracy
- Size and part number are laser branded on the blade for easy identification
- Standard: ISO 8764

R	mm	mm	mm	mm	mm	mm	g
409V-0-100	10	PH-0	100	90	190	40	
409V-1-150	10	PH-1	150	100	260	80	
409V-2-175	10	PH-2	175	110	285	120	
409V-3-200	5	PH-3	200	120	320	180	

POZIDRIV INSULATED 1000V SCREWDRIVERS



- For work on live equipment, up to 1000V
- 2-component handle with hanging hole
- Blade is made of high performance alloy steel, insulation moulded directly onto blade. Black finish tip for higher accuracy
- Size and part number are laser branded on the blade for easy identification
- Standard: ISO 8764

R	mm	mm	mm	mm	mm	mm	g
413V-0-100	10	PZ-0	100	90	190	40	
413V-1-150	10	PZ-1	150	100	260	80	
413V-2-175	10	PZ-2	175	110	285	120	
413V-3-200	5	PZ-3	200	120	320	180	

TORX® INSULATED 1000V SCREWDRIVERS



- For work on live equipment, up to 1000V
- 2-component handle with hanging hole
- Blade is made of high performance alloy steel, insulation moulded directly onto blade. Black finish tip for higher accuracy
- Size and part number are laser branded on the blade for easy identification
- Standard: ISO 8764

R	mm	mm	mm	mm	mm	mm	g
414V-10-100	10	T-10	100	90	190	320	
414V-15-125	10	T-15	125	100	225	650	
414V-20-125	10	T-20	125	100	225	750	
414V-25-150	10	T-25	150	110	360	900	

TWIN PACK INSULATED SCREWDRIVERS + TESTER

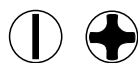

- Screwdriver set, 3 pcs
- Includes 2 screwdrivers and 1 main tester 150V-250V
- For slotted and Phillips head screws

Code	Quantity	Weight (kg)	Dimensions (mm)	Material	Head Type	Image
459V-3-1	1	3	35x130x310	35		
408V-4-100					⊖	
409V-1-150					⊕	
429-03-1					⊖	

SCREWDRIVER SETS

SCREWDRIVER SET, 6 pieces



- For slotted and Phillips head screws
- In cardboard box

Code	Quantity	Weight (kg)	Dimensions (mm)	Material	Head Type	Image
459-6-C	1	6	42x325x160	570		
408-3-75, 408-4-100					⊖	
407-5.5-125, 407-6.5-150					⊖	
409-1-100, 409-2-125					⊕	

SCREWDRIVER SET FOR ENGINEERINGS, 6 pieces

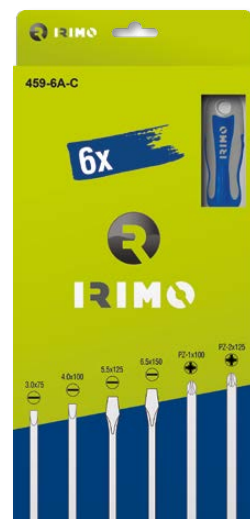

- For slotted and Pozidriv head screws
- In cardboard box

Code	Quantity	Weight (kg)	Dimensions (mm)	Material	Head Type	Image
459-6A-C	1	6	42x325x160	570		
408-3-75, 408-4-100					⊖	
407-5.5-125, 407-6.5-150					⊖	
413-1-100, 413-2-125					⊕	



SCREWDRIVER SETS

SCREWDRIVER SET, 5 pieces

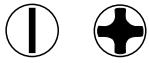

- For slotted and Phillips head screws
- In clamshell packaging

459-5-B	1	5		435
408-3-75, 408-4-100				
407-6.5-150				
409-1-100, 409-2-125				

SCREWDRIVER SET, 6 pieces



- For TORX® head screws
- In cardboard box

459-6B-C	1	6	42 x 325 x 160	470
414-10-75, 414-15-100, 414-20-100, 414-25-125, 414-27-125, 414-30-150				

SCREWDRIVER SET FOR ELECTRICIANS, 6 pieces

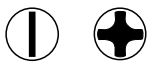

- For slotted and Phillips head screws
- In cardboard box

459-6C-C	1	6	42 x 325 x 160	505
408-3-100, 408-4-125, 408-5.5-150				
409-1-100, 409-2-125				
429-03-1				

SCREWDRIVER DISPLAYS

SCREWDRIVERS DISPLAY, 83 pieces



- Screwdriver display of 83 pieces
- For slotted and Phillips head screws

IRIMO	Box	Box X	Box	Weight
910-83DISP	1	83	500x450x250	8.500
MEE-COUNT-IR-2 Stand alone				
8x 408-3-75, 8x 408-4-100, 6x 408-5.5-150, 7x 408-6.5-150				
6x 407-10-200, 8x 407-4-100, 7x 407-5.5-125, 6x 407-6.5-150, 6x 407-8-175				
8x 409-0-75, 7x 409-1-100, 6x 409-2-125				

SCREWDRIVERS DISPLAY, 152 pieces



- Screwdriver display of 152 pieces
- For slotted, Phillips and TORX® head screws

IRIMO	Box	Box X	Box	Weight
910-152DISP	1	152	775x450x250	14.100
MEE-COUNT-IR-3 Stand alone				
8x 408-2.5-75, 8x 408-3.5-100, 8x 408-3-75, 8x 408-4-100, 7x 408-5.5-125, 6x 408-6.5-150				
6x 407-10-200, 8x 407-4-100, 7x 407-5.5-125, 6x 407-6.5-150, 6x 407-8-175				
6x 408-6.5-25				
8x 409-0-75, 7x 409-1-100, 6x 409-2-125, 6x 409-3-150				
6x 409-2-25				
8x 414-10, 7x 414-15, 7x 414-20, 7x 414-25, 6x 414-30				



INSULATED SCREWDRIVER SETS

INSULATED 1000V SCREWDRIVER SET, 6 pieces

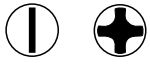

- Screwdriver set of 6 pieces
- For slotted and Phillips head screws
- In cardboard box

Part No.	Box	Quantity	Dimensions	Weight
459V-6-C	1	6	42 x 325 x 160	580
408V-2.5-100, 408V-4-100, 408V-5.5-125, 408V-6.5-150				
409V-1-150, 409V-2-175				

INSULATED SCREWDRIVER DISPLAYS

INSULATED SCREWDRIVERS DISPLAY, 72 pieces

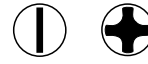

- Insulated screwdrivers display, 72 pieces
- For slotted and Phillips head screws

Part No.	Box	Quantity	Dimensions	Weight
910V-72DISP	1	72	500 x 450 x 250	9.075
MEE-COUNT-IR-2		Stand alone		
8x 408V-2.5-100, 8x 408V-3.5-100, 8x 408V-3-100, 8x 408V-4-100, 7x 408V-5.5-125, 6x 408V-6.5-150, 6x 408V-8-175				
8x 409V-0-100, 7x 409V-1-150, 6x 409V-2-175				

T-HANDLE SCREWDRIVERS

T-HANDLE WITH HEXAGONAL TIP

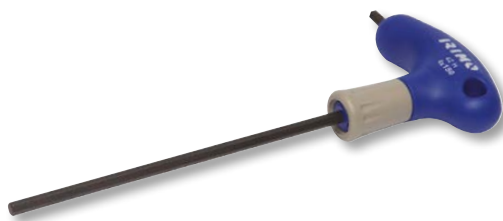

- Blade is made of high quality steel. Black finish
- The long blade allows to apply a controlled torque and provides an easy access to screws requiring depth
- The short 90° blade is used for extreme torque or to work in areas where height is limited
- Size and part number are laser branded on the blade for easy identification
- Rotating cap in the handle that allows a fast finger movement during turning reducing tightening time

Part No.	Box	Quantity	Blade Length	Blade Width	Blade Height	Weight
42-H2-100	5	2	130	100	64 x 30	23
42-H2.5-100	5	2.5	130	100	64 x 30	25
42-H3-100	5	3	130	100	64 x 30	28
42-H4-150	5	4	190	150	80 x 40	57
42-H5-150	5	5	190	150	80 x 40	70
42-H6-200	5	6	250	200	100 x 50	134
42-H8-200	5	8	250	200	100 x 50	186
42-H10-200	5	10	250	200	100 x 50	254

T-HANDLE WITH TORX® TIP



- Blade is made of high quality steel. Black finish
- The long blade allows to apply a controlled torque and provides an easy access to screws requiring depth
- The short 90° blade is used for extreme torque or to work in areas where height is limited
- Size and part number are laser branded on the blade for easy identification
- Rotating cap in the handle that allows a fast finger movement during turning reducing tightening time

Part No.	Blade Length (mm)	Blade Width (mm)	Blade Height (mm)	Blade Thickness (mm)	Blade Depth (mm)	Weight (g)
46-T10-100	5	T10	2.72	130	100	64x30 27
46-T15-150	5	T15	3.26	190	150	80x40 55
46-T20-150	5	T20	3.84	190	150	80x40 55
46-T25-150	5	T25	4.40	190	150	80x40 66
46-T30-200	5	T30	5.49	250	200	100x50 126
46-T40-200	5	T40	6.60	250	200	100x50 147

T-HANDLE WITH HEXAGONAL BALL TIP



- Blade: high quality steel. Black finish
- The long blade allows to apply a controlled torque and provides an easy access to screws requiring depth
- The short 90° blade is used for extreme torque or to work in areas where height is limited
- Ball end allows to easily insert the tip in the screw head from a range of angles
- More efficient and time saving than a standard T Handle
- Branding: size and part number laser branded in the blade for easier identification

Part No.	Blade Length (mm)	Blade Width (mm)	Blade Height (mm)	Blade Thickness (mm)	Blade Depth (mm)	Weight (g)
42B-H3-100	5	3	130	100	64x30	28
42B-H4-150	5	4	190	150	80x40	57
42B-H5-150	5	5	190	150	80x40	70
42B-H6-200	5	6	250	200	100x50	134
42B-H8-200	5	8	250	200	100x50	186
42B-H10-200	5	10	250	200	100x50	254

T-HANDLE SCREWDRIVERS, NUT DRIVER



- Blade is made of high quality steel
- Size and part number are laser branded on the blade for easy identification
- Rotating cap in the handle that allows a fast finger movement during turning reducing tightening time

Part No.	Blade Length (mm)	Blade Width (mm)	Blade Height (mm)	Blade Thickness (mm)	Blade Depth (mm)	Weight (g)
191-6-150	5	6	190	150	69x40	78
191-7-175	5	7	225	175	84x50	121
191-8-175	5	8	225	175	84x50	123
191-10-175	5	10	225	175	84x50	160
191-12-175	5	12	225	175	84x50	167
191-13-175	5	13	225	175	84x50	172

HEX BALL END T HANDLE SET, 6 pieces



- T-handle hexagonal ball tip, 6 pcs
- In clamshell packaging

Part No.	Blade Length (mm)	Blade Width (mm)	Blade Height (mm)	Blade Thickness (mm)	Blade Depth (mm)	Weight (g)
42B-6-B	1	6	355x247x40			120

42B-H10-200, 42B-H3-100, 42B-H4-150, 42B-H5-150, 42B-H6-200, 42B-H8-200

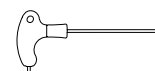

6 IN 1 SCREWDRIVER



- Double ended bits (6.35 x 65 mm): PH1 - 5 mm
- Double ended bits (8 x 75 mm): PH2 - 6 mm
- Nut Driver: 6 mm - 8 mm

475-5-1	1	1/4" / 5/16"	50	110	160	312

REVERSIBLE SCREWDRIVER



- Impact resistant plastic handle
- Blade is made of high performance alloy steel. Nickel plated blade

427411	10	1.2	6	PH-2	156	26

MAGNETISER



- For magnetizing and demagnetizing different tools
- Simple and easy to use small devise
- Material: magnet, plastic
- Packaging: in blister pack

458-02-1	5	53x50x30	164

PRECISION SCREWDRIVER

PRECISION SCREWDRIVER SET, 6 pieces



- Precision screwdriver set, 6 pcs
- Chrome Vanadium steel blades
- Chrome plated finish and black tips
- Free turning caps for easy and accurate driving
- Sliding system of the plastic frame to open and release
- Sizes included:
 - 4 slotted: 1.6-2.0-2.5-3.0 mm
 - 2 Phillips: PH00-PH0

IRIMO	Icons	mm	mm	g
461-6-B	1	150	50	120

POCKET PRECISION SCREWDRIVER



478-4-1



478-4-2



- 4 ends tips: PH0 / 3 mm and PH1/4 mm
- Satin finish, head treated bits
- Easy carrying pen size with clip

IRIMO	Icons	mm	mm	mm	g
478-4-1	1	PH0/PH1	120	3.0/4.0	20
478-4-2	48	PH0/PH1	120	3.0/4.0	1.100

VOLTAGE TESTER



429-03-1
429-04-1



429-10-1

- Handle: clear transparent plastic handle, impact resistant
- Blade: high quality steel, nickel plated blade, plastic protection up to the tip
- According to DIN VDE0680/6 GS-marked
- 429-10-1: Auto tester 6-24-V

IRIMO	Icons	mm	mm	mm	mm	mm	g
429-03-1	6	0.6	3.0	65	75	140	30
429-04-1	6	-	3.5	100	90	190	29
429-10-1	6	-	3.0	45	75	120	22



NICKEL PLATED KEYS FOR HEX SCREWS

NICKEL PLATED KEYS, METRIC



- High quality steel, entirely hardened
- Nickel plated
- Size stamped on the blade for easy identification
- Standard: ISO 2936

Part No.	Box Qty	Hex Size (mm)	a (mm)	b (mm)	Weight (g)
040001	10	1.5	15	47	1
040011	10	2.0	18	52	1
040021	10	2.5	21	59	3
040031	10	3.0	23	66	4
040041	10	4.0	29	74	10
040051	10	5.0	33	85	18
040061	10	6.0	38	96	29
040071	10	7.0	41	102	41
040081	10	8.0	44	108	57
040091	5	9.0	47	114	76
040101	5	10.0	50	122	100
040121	5	12.0	57	137	163
040141	1	14.0	70	154	253
040171	1	17.0	80	177	427
040191	1	19.0	89	199	600
040221	1	22.0	102	222	910

NICKEL PLATED KEYS, INCHES



- High quality steel, entirely hardened
- Nickel plated
- Size stamped on the blade for easy identification
- Standard: ISO 2936

Part No.	Box Qty	Hex Size (in)	a (mm)	b (mm)	Weight (g)
040541	10	1/16"	15	47	1
040011	10	5/64"	18	52	1
040561	10	3/32"	21	59	3
040581	10	1/8"	23	66	4
040041	10	5/32"	29	74	10
040601	10	3/16"	33	85	18
040611	10	7/32"	35.5	91	29
040621	10	1/4"	38	96	32
040641	10	5/16"	44	108	60
040661	5	3/8"	50	122	100
040681	5	7/16"	53	129	140
040701	5	1/2"	63	145	182
040731	1	5/8"	76	168	370
040191	1	3/4"	89	199	601

NICKEL PLATED KEYS SETS, METRIC



- In plastic wallet
- Sizes marked at the top of the wallet, for an easy identification
- Hanging hole

Part No.	Box Qty	Quantity	Hex Sizes (mm)	Weight (g)
041011	1	6	2.0, 2.5, 3.0, 4.0, 5.0, 6.0 mm	76
041071	1	8	2.0, 2.5, 3.0, 4.0, 5.0, 6.0, 7.0, 8.0 mm	180
041021	1	10	2.0, 2.5, 3.0, 4.0, 5.0, 6.0, 7.0, 8.0, 10, 12 mm	380
041091	1	11	2.0, 2.5, 3.0, 4.0, 5.0, 6.0, 7.0, 8.0, 9.0, 10, 12 mm	570
041031	1	13	2.0, 2.5, 3.0, 4.0, 5.0, 6.0, 7.0, 8.0, 10, 12, 14, 17, 19 mm	1.800
041101	1	15	2.0, 2.5, 3.0, 4.0, 5.0, 6.0, 7.0, 8.0, 9.0, 10, 12, 14, 17, 19, 22 mm	2.920

NICKEL PLATED KEYS SETS, INCHES



- In plastic wallet
- Sizes marked at the top of the wallet, for an easy identification
- Hanging hole

Part No.	Box Qty	Quantity	Hex Sizes (in)	Weight (g)
041041	1	5	1/8, 5/32, 3/16, 7/32, 1/4"	95
041051	1	9	1/8, 5/32, 3/16, 7/32, 1/4, 5/16, 3/8, 7/16, 1/2"	580
041061	1	12	1/8, 5/32, 3/16, 7/32, 1/4, 5/16, 3/8, 7/16, 1/2, 9/16, 5/8, 3/4"	1.865

NICKEL PLATED KEYS SETS



• On ring

Code	Box	Ring	Sizes	Weight
041111	1	6	2-2.5-3-4-5-6 mm	77
041121	1	8	2-2.5-3-4-5-6-8-10 mm	240

OFFSET SCREWDRIVER SET, 3 pieces



- 3 pieces with double tips (Slotted & Phillips)
- Chrome plated keys set for hex screws, in metric
- Content: Slotted (5.0, 6.0, 8.0 mm); Phillips (PH1, PH2, PH3)
- Packaging: in blister pack

Code	Box	Blister	Dimensions	Weight
420-3-1	1	3	20x230x100	202

CHROME PLATED KEYS FOR HEX SCREWS, LONG

CHROME PLATED BLADE SET FOR HEX SCREWS, LONG BALL END METRIC



- Set of long ball end hex keys, 9 pieces, metric
- In plastic holder with hanging hole
- Sizes marked at the top of the lid, for an easy identification
- In blister packaging

Code	Box	Blister	Dimensions	Weight
48-9C-H	1	9	1.5-2-2.5-3-4-5-6-8-10 mm	360

BLACK KEYS FOR HEX SCREWS

BLACK KEYS, METRIC



- High quality steel, entirely hardened
- Black finish
- Size stamped on the blade for easy identification
- Standard: ISO 2936

Code	Box	Hex	a mm	b mm	Weight
045001	10	1.5	15	47	1
045011	10	2.0	18	52	2
045021	10	2.5	21	59	3
045031	10	3.0	23	66	4
045041	10	4.0	29	74	10
045051	10	5.0	33	85	13
045061	10	6.0	38	95	29
045071	10	7.0	41	102	41
045081	10	8.0	44	105	57
045091	5	9.0	47	114	76
045101	5	10.0	50	122	100
045121	5	12.0	57	137	163
045141	1	14.0	70	154	253
045171	1	17.0	80	177	427
045191	1	19.0	89	199	600
045221	1	22.0	102	222	910



BLACK KEYS FOR HEX SCREWS

BLACK KEYS, METRIC

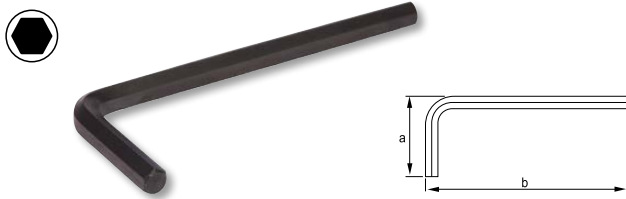

- High quality steel, entirely hardened
- Black finish
- Size stamped on the blade for easy identification
- Standard: ISO 2936

Code	Box	Hex Size (mm)	a (mm)	b (mm)	Weight (g)
45-00-1	1	1.5	14.5	45.5	5.4
45-01-1	1	2.0	27.0	51.0	6.4
45-02-1	1	2.5	19.5	55.5	7.5
45-03-1	1	3.0	22.0	64.0	9.4
45-04-1	1	4.0	28.0	72.0	14.4
45-05-1	1	5.0	22.0	83.0	22.4
45-06-1	1	6.0	38.0	94.0	33.8
45-08-1	1	7.0	37.0	105.0	63.8
45-10-1	1	10.0	49.0	119.0	107.3

BLACK KEYS SETS, METRIC



- Set of black finish hex keys, 9 pieces, metric
- In plastic holder with hanging hole
- Sizes marked at the top of the wallet, for an easy identification
- In blister packaging

Code	Box	Quantity	Hex Sizes (mm)	Weight (g)
46-9-H	1	9	1.5, 2, 2.5, 3, 4, 5, 6, 8, 10 mm	270

BLACK KEYS SETS, METRIC



- In plastic wallet
- Sizes marked at the top of the wallet, for an easy identification
- Hanging hole

Code	Box	Quantity	Hex Sizes (mm)	Weight (g)
046011	1	6	2.0, 2.5, 3.0, 4.0, 5.0, 6.0 mm	76
046021	1	10	2.0, 2.5, 3.0, 4.0, 5.0, 6.0, 7.0, 8.0, 10, 12 mm	180
046091	1	11	2.0, 2.5, 3.0, 4.0, 5.0, 6.0, 7.0, 8.0, 9.0, 10, 12 mm	460
046031	1	13	2.0, 2.5, 3.0, 4.0, 5.0, 6.0, 7.0, 8.0, 10, 12, 17, 19 mm	1.805
046101	1	15	2.0, 2.5, 3.0, 4.0, 5.0, 6.0, 7.0, 8.0, 9.0, 10, 12, 14, 17, 19, 22 mm	2.830

BLACK KEYS SETS, METRIC



- Set of black finish hex keys, 8 pieces, metric
- In high quality impact resistant folder
- Allows many different working positions
- Positive stop at 270° degrees, for maximum leverage
- Easy to store
- Retail packaging with hanger

Code	Box	Quantity	Hex Sizes (mm)	Weight (g)
46-8-F	1	8	1.5, 2.0, 2.5, 3.0, 4.0, 5.0, 6.0, 8.0 mm	160

BLACK KEYS, INCHES



- High quality steel, entirely hardened
- Black finish
- Size stamped on the blade for easy identification
- Standard: ISO 2936

Part No.	Box Qty	Hex Size	a mm	b mm	g
045541	10	1/16"	15	47	1
045011	10	5/64"	18	52	2
045561	10	3/32"	21	59	3
045581	10	1/8"	23	66	5
045041	10	5/32"	29	74	10
045601	10	3/16"	33	85	16
045611	10	7/32"	35.5	91	24
045621	10	1/4"	38	96	32
045641	10	5/16"	44	105	60
045661	5	3/8"	50	122	100
045681	5	7/16"	53	129	140
045701	5	1/2"	63	145	182
045731	1	5/8"	76	168	370
045191	1	3/4"	89	199	601

BLACK KEYS SETS, INCHES



- In plastic wallet
- Sizes marked at the top of the wallet, for an easy identification
- Hanging hole

Part No.	Box Qty	Box Qty	Hex Sizes	g
046041	1	5	1/8, 5/32, 3/16, 7/32, 1/4"	95
046051	1	9	1/8, 5/32, 3/16, 7/32, 1/4, 5/16, 3/8, 7/16, 1/2"	580
046061	1	12	3/32, 1/8, 5/32, 3/16, 7/32, 1/4, 5/16, 3/8, 7/16, 1/2, 5/8, 3/4"	1.865

BLACK KEYS FOR HEX SCREWS, LONG

BLACK KEYS, METRIC LONG

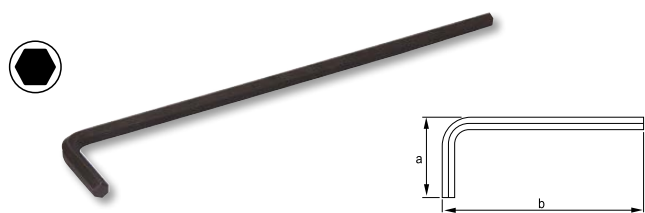

- High quality steel, entirely hardened
- Black finish
- Size laser marking on the blade for an easy identification
- Long arm provides higher torque transmission and accessibility
- Standard: ISO 2936

Part No.	Box Qty	Hex Size	a mm	b mm	g
045801	10	1.5	15	91	1
045811	10	2.0	18	102	3
045821	10	2.5	21	114	5
045831	10	3.0	23	129	8
045841	10	4.0	29	144	17
045851	10	5.0	33	165	31
045861	10	6.0	38	186	51
045871	10	7.0	41	197	64
045881	5	8.0	44	208	100
045891	5	9.0	47	219	134
045901	5	10.0	50	234	175
045921	2	12.0	57	262	283
045941	2	14.0	70	294	439



BLACK KEYS FOR HEX SCREWS, LONG

LONG BALL END, METRIC

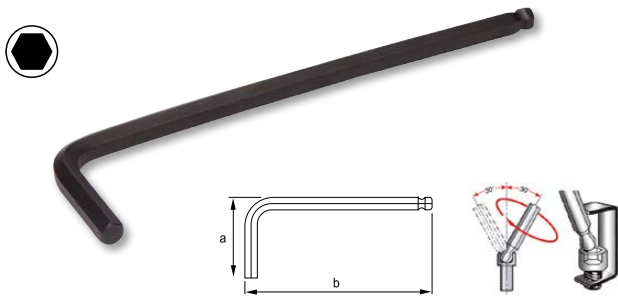

- High quality steel, entirely hardened. Black finish
- Size laser marking on the blade for an easy identification
- Long arm provides higher torque transmission and accessibility
- Ball end allows to easily insert the key in the screw head from a range of angles
- More efficient and time saving than a standard hex key
- Standard: ISO 2936

R	Box	mm	a mm	b mm	g
047001	10	1.5	15	91	1
047011	10	2.0	18	102	3
047021	10	2.5	21	114	5
047031	10	3.0	23	129	8
047041	10	4.0	29	144	17
047051	10	5.0	33	165	31
047061	10	6.0	38	186	50
047081	10	8.0	44	208	100
047101	5	10.0	50	234	171
047121	2	12.0	57	262	275

LONG BALL END, METRIC



- Set of long ball end hex keys, 9 pieces, metric
- In plastic holder with hanging hole
- Sizes marked at the top of the lid, for an easy identification
- In blister packaging

R	Box	X	mm	g
48-9-H	1	9	1.5, 2, 2.5, 3, 4, 5, 6, 8, 10 mm	360

LONG BALL END, METRIC

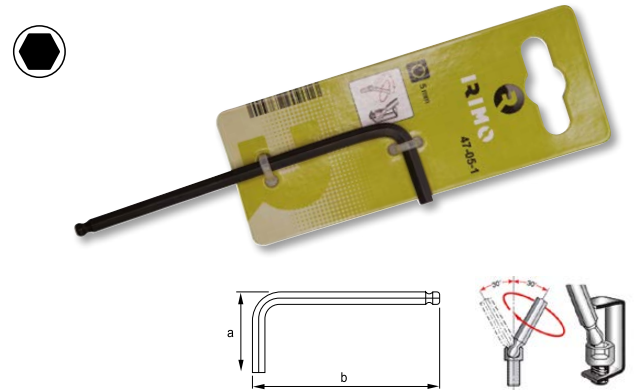

- High quality steel, entirely hardened. Black finish
- Size laser marking on the blade for an easy identification
- Long arm provides higher torque transmission and accessibility
- Ball end allows to easily insert the key in the screw head from a range of angles
- More efficient and time saving than a standard hex key
- Standard: ISO 2936

R	Box	mm	a mm	b mm	g
47-00-1	1	1.5	14.5	62.5	6.0
47-01-1	1	2.0	17.0	76.0	7.2
47-02-1	1	2.5	19.5	85.5	8.8
47-03-1	1	3.0	22.0	91.0	11.0
47-04-1	1	4.0	28.0	102.0	17.6
47-05-1	1	5.0	32.0	118.0	28.0
47-06-1	1	6.0	37.0	139.0	44.4
47-08-1	1	8.0	43.0	155.0	82.6
47-10-1	1	10.0	49.0	177.0	144.0

LONG BALL END, INCHES



- Set of long ball end hex keys, 13 pieces
- In plastic holder with hanging hole
- Sizes marked at the top of the lid, for an easy identification
- In blister packaging

R	Box	X	Inches	g
48A-13-H	1	9	0.05-1/16-5/64-3/32-7/64-1/8-9/64-5/32-3/16-7/32-1/4-5/16-3/8"	360

BLACK KEYS FOR TORX® SCREWS

BLACK KEYS FOR TORX® SCREWS



- High quality steel, entirely hardened
- Black finish
- Size laser marking on the blade for an easy identification
- Long arm provides higher torque transmission and accessibility

Q	Box	Recycle	a mm	b mm	g
457061	5	T-6	15	75	4
457071	5	T-7	16	80	4
457081	5	T-8	16	80	5
457091	5	T-9	16	80	5
457101	5	T-10	17	86	6
457151	5	T-15	18	90	10
457201	5	T-20	19	95	11
457251	5	T-25	20	100	17
457271	5	T-27	21	105	19
457301	5	T-30	24	114	29
457401	5	T-40	26	124	43
457451	5	T-45	29	133	61
457501	5	T-50	32	152	88

BLACK KEY SET FOR TORX® SCREWS



- Set of long black finish offset screwdrivers for TORX® head screws, 9 pieces
- All sizes marked on the holder for an easy selection
- Hanging hole
- In blister packaging

Q	Box	X	Recycle	g
458-9-H	10	9	T10, T15, T20, T25, T27, T30, T40, T45, T50	290

BLACK KEYS FOR TORX® SCREWS



- High quality steel, entirely hardened
- Black finish
- Size laser marking on the blade for an easy identification
- Long arm provides higher torque transmission and accessibility

Q	Box	Recycle	a mm	b mm	g
457-10-1	1	T10	17	86	10.0
457-15-1	1	T15	18	90	12.2
457-20-1	1	T20	19	95	15.2
457-25-1	1	T20	20	100	18.8
457-27-1	1	T27	21	105	23.2
457-30-1	1	T30	24	114	28.0
457-40-1	1	T40	26	124	48.2
457-45-1	1	T45	29	133	66.4
457-50-1	1	T50	32	152	94.2

BLACK KEY SET FOR TORX® SCREWS



- Set of black finish offset screwdrivers for TORX® head screws, 8 pieces
- Impact resistant holder
- Allows many different working positions
- Positive stop at 270° degrees, for maximum leverage
- In blister packaging

Q	Box	X	Recycle	g
458-8-F	1	8	T9, T10, T15, T20, T25, T27, T30, T40	160



BLACK KEYS FOR TORX® TAMPER RESISTANT SCREWS

BLACK KEYS FOR TORX® TAMPER RESISTANT SCREWS

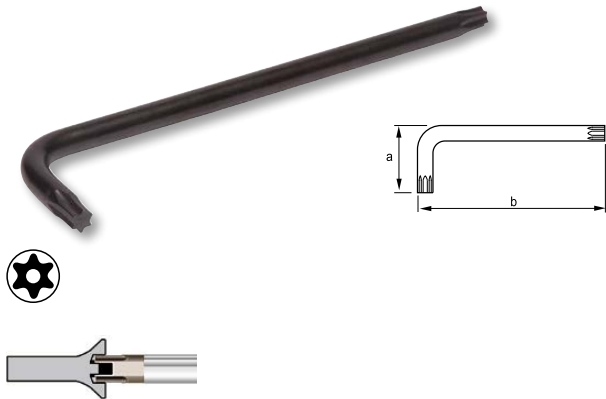

- High quality steel, entirely hardened
- Black finish
- Size laser marking on the blade for easy identification
- Long arm provides higher torque transmission and accessibility

Part No.	Quantity	Material	a mm	b mm	Ø mm	g
454091	5	TR9	16	80	3.0	4
454101	5	TR10	17	86	3.0	5
454151	5	TR15	18	90	4.0	8
454201	5	TR20	19	95	4.0	11
454251	5	TR25	20	100	5.0	17
454271	5	TR27	21	105	5.0	19
454301	5	TR30	24	114	6.0	29
454401	5	TR40	26	124	7.0	43

BLACK KEY SETS FOR TORX® TAMPER RESISTANT SCREWS



- Set of long black finish offset screwdrivers for TORX® tamper head screws, 9 pieces
- All sizes marked on the holder for an easy selection
- Hanging hole
- In blister packaging

Part No.	Quantity	Material	g
454-9-H	10	TR10, TR15, TR20, TR25, TR27, TR30, TR40, TR45, TR50	290

BLACK KEY SETS FOR TORX® TAMPER RESISTANT SCREWS



- Set of black finish offset screwdrivers for TORX® tamper head screws, 8 pieces
- Impact resistant holder
- Allows many different working positions
- Positive stop at 270° degrees, for maximum leverage
- In blister packaging

Part No.	Quantity	Material	g
454-8-F	1	TR9, TR10, TR15, TR20, TR25, TR27, TR30, TR40	160

1/4" BITS

1/4" BITS FOR SLOTTED SCREWS, 25 MM



- Drive: 1/4" DIN 3126-C 6,3, ISO 1173
- Finish: sand blasting
- Material: high performance alloy steel
- Application: for all screw applications in trade and industry
- In plastic box for 10 pieces

E	Icon	mm	mm	L mm	g
475-4-1	1	0.5	4.0	25	35
475-4.5-1	1	0.6	4.5	25	35
475-5.5-1	1	0.8	5.5	25	35
475-6.0-1	1	1.0	6.0	25	35
475-6.5-1	1	1.2	6.5	25	35
475-8.0-1	1	1.6	8.0	25	35

1/4" BITS SLOTTED SCREWS, 70 MM



- Drive: 1/4" DIN 3126-C 6,3, ISO 1173
- Finish: sand blasting
- Material: high performance alloy steel
- Application: for all screw applications in trade and industry
- In plastic box for 5 pieces

E	Icon	mm	mm	L mm	g
475-70-3.0-1	1	0.5	3.0	70	70
475-70-3.5-1	1	0.6	3.5	70	70
475-70-5.5-1	1	0.8	5.5	70	77
475-70-6.5-1	1	1.2	6.5	70	80

1/4" BITS FOR PHILLIPS SCREWS, 25 MM



- Drive: 1/4" DIN 3126-C 6,3, ISO 1173
- Finish: sand blasting
- Material: high performance alloy steel
- Application: for all screw applications in trade and industry
- In plastic box for 10 pieces

E	Icon	mm	g
475-PH0-1	1	PH-0	25 35
475-PH1-1	1	PH-1	25 35
475-PH2-1	1	PH-2	25 35
475-PH3-1	1	PH-3	25 35

1/4" BITS FOR PHILLIPS SCREWS, 50 MM



- Drive: 1/4" DIN 3126-E 6,3, ISO 1173
- Finish: sand blasting
- Material: high performance alloy steel
- Application: for all screw applications in trade and industry
- In plastic box for 5 pieces

E	Icon	mm	g
475-50PH1-1	1	PH-1	50 70
475-50PH2-1	1	PH-2	50 70
475-50PH3-1	1	PH-3	50 77

1/4" BITS FOR PHILLIPS SCREWS, 70 MM



- Drive: 1/4" DIN 3126-E 6,3, ISO 1173
- Finish: sand blasting
- Material: high performance alloy steel
- Application: for all screw applications in trade and industry
- In plastic box for 5 pieces

E	Icon	mm	g
475-70PH1-1	1	PH-1	70 70
475-70PH2-1	1	PH-2	70 70
475-70PH3-1	1	PH-3	70 77



1/4" BITS

1/4" BITS FOR PHILLIPS SCREWS, 89 MM



- Drive: 1/4" DIN 3126-E 6,3, ISO 1173
- Finish: sand blasting
- Material: high performance alloy steel
- Application: for all screw applications in trade and industry
- In plastic box for 5 pieces

R				
475-89PH1-1	1	PH-1	89	100
475-89PH2-1	1	PH-2	89	100
475-89PH3-1	1	PH-3	89	110

1/4" BITS FOR PHILLIPS SCREWS, 150 MM



- Drive: 1/4" DIN 3126-E 6,3, ISO 1173
- Finish: sand blasting
- Material: high performance alloy steel
- Application: for all screw applications in trade and industry
- In plastic box for 5 pieces

R				
475-150PH1-1	1	PH-1	150	150
475-150PH2-1	1	PH-2	150	150

1/4" BITS FOR PHILLIPS DRY WALL SCREWS, 25 MM



- Drive: 1/4" DIN 3126-C 6,3, ISO 1173
- Finish: sand blasting
- Material: high performance alloy steel
- Application: Grabber bits for drywall screws
- With reduced nose diameter 4.8 mm
- In plastic box of 10 pieces

R				
475-PH2G-1	1	PH-2G	25	35

1/4" BITS FOR POZIDRIV SCREWS, 25 MM



- Drive: 1/4" DIN 3126-C 6,3, ISO 1173
- Finish: sand blasting
- Material: high performance alloy steel
- Application: for all screw applications in trade and industry
- In plastic box of 10 pieces

R				
475-PZ0-1	1	PZ-0	25	35
475-PZ1-1	1	PZ-1	25	35
475-PZ2-1	1	PZ-2	25	35
475-PZ3-1	1	PZ-3	25	35

1/4" BITS FOR POZIDRIV SCREWS, 50 MM



- Drive: 1/4" DIN 3126-E 6,3, ISO 1173
- Finish: sand blasting
- Material: high performance alloy steel
- Application: for all screw applications in trade and industry
- In plastic box of 5 pieces

R				
475-50PZ1-1	1	PZ-1	50	70
475-50PZ2-1	1	PZ-2	50	70
475-50PZ3-1	1	PZ-3	50	77

1/4" BITS FOR POZIDRIV SCREWS, 70 MM



- Drive: 1/4" DIN 3126-E 6,3, ISO 1173
- Finish: sand blasting
- Material: high performance alloy steel
- Application: for all screw applications in trade and industry
- In plastic box of 5 pieces

Part No.	Qty	Drive	L mm	g
475-70PZ1-1	1	PZ-1	70	70
475-70PZ2-1	1	PZ-2	70	70
475-70PZ3-1	1	PZ-3	70	77

1/4" BITS FOR POZIDRIV SCREWS, 89 MM



- Drive: 1/4" DIN 3126-E 6,3, ISO 1173
- Finish: sand blasting
- Material: high performance alloy steel
- Application: for all screw applications in trade and industry
- In plastic box of 5 pieces

Part No.	Qty	Drive	L mm	g
475-89PZ1-1	1	PZ-1	89	100
475-89PZ2-1	1	PZ-2	89	100
475-89PZ3-1	1	PZ-3	89	110

1/4" BITS FOR POZIDRIV SCREWS, 150 MM



- Drive: 1/4" DIN 3126-E 6,3, ISO 1173
- Finish: sand blasting
- Material: high performance alloy steel
- Application: for all screw applications in trade and industry
- In plastic box of 5 pieces

Part No.	Qty	Drive	L mm	g
475-150PZ1-1	1	PZ-1	150	150
475-150PZ2-1	1	PZ-2	150	150

1/4" BITS FOR TORX® SCREWS, 25 MM



- Drive: 1/4" DIN 3126-C 6,3, ISO 1173
- Finish: sand blasting
- Material: high performance alloy steel
- Application: for all screw applications in trade and industry
- In plastic box of 10 pieces (T30/T40 packed in box of 5 pieces)

Part No.	Qty	Drive	Star Size mm	L mm	g
475-T5-1	1	T5	1.70	25	30
475-T6-1	1	T6	1.70	25	30
475-T7-1	1	T7	1.99	25	35
475-T8-1	1	T8	2.31	25	35
475-T9-1	1	T9	2.50	25	35
475-T10-1	1	T10	2.74	25	35
475-T15-1	1	T15	3.27	25	35
475-T20-1	1	T20	3.86	25	35
475-T25-1	1	T25	4.43	25	35
475-T27-1	1	T27	4.99	25	35
475-T30-1	1	T30	5.52	25	40
475-T40-1	1	T40	6.65	25	50
475-T45-1	1	T45	7.90	25	70
475-T50-1	1	T50	7.94	25	80

1/4" BITS FOR TORX® SCREWS, 50 MM



- Drive: 1/4" DIN 3126-C 6,3, ISO 1173
- Finish: sand blasting
- Material: high performance alloy steel
- Application: for all screw applications in trade and industry
- In plastic box of 5 pieces

Part No.	Qty	Drive	Star Size mm	L mm	g
475-50T6-1	1	T6	1.70	50	38
475-50T8-1	1	T8	2.51	50	40
475-50T10-1	1	T10	2.74	50	42
475-50T15-1	1	T15	3.27	50	44
475-50T20-1	1	T20	3.86	50	46
475-50T25-1	1	T25	4.43	50	50
475-50T30-1	1	T30	5.52	50	52
475-50T40-1	1	T40	6.65	50	54

1/4" BITS

1/4" BITS FOR TORX® SCREWS, 89 MM



x5

- Drive: 1/4" DIN 3126-C 6,3, ISO 1173
- Finish: sand blasting
- Material: high performance alloy steel
- Application: for all screw applications in trade and industry
- In plastic box of 5 pieces

R					
			mm	mm	g
475-89T10-1	1	T10	2.74	89	80
475-89T15-1	1	T15	3.27	89	85
475-89T20-1	1	T20	3.86	89	90
475-89T25-1	1	T25	4.43	89	100
475-89T27-1	1	T27	4.99	89	100
475-89T30-1	1	T30	5.52	89	110
475-89T40-1	1	T40	6.65	89	120

1/4" BITS FOR TORX® SCREWS, 150 MM



x5

- Drive: 1/4" DIN 3126-C 6,3, ISO 1173
- Finish: sand blasting
- Material: high performance alloy steel
- Application: for all screw applications in trade and industry
- In plastic box of 5 pieces

R					
			mm	mm	g
475-150T10-1	1	T10	2.74	150	150
475-150T15-1	1	T15	3.27	150	150
475-150T20-1	1	T20	3.86	150	153
475-150T25-1	1	T25	4.43	150	155
475-150T30-1	1	T30	5.52	150	157
475-150T40-1	1	T40	6.65	150	160

1/4" BITS FOR TORX® TAMPER SCREWS, 25 MM



x5

- Drive: 1/4" DIN 3126-C 6,3, ISO 1173
- Finish: sand blasting
- Material: high performance alloy steel
- Application: for all screw applications in trade and industry
- TORX® tamper resistant screws have a centre pin to prevent a standard TORX® driver to be inserted
- In plastic box of 5 pieces

R					
			mm	mm	g
475-TR10-1	1	T10	2.74	25	35
475-TR15-1	1	T15	3.27	25	35
475-TR20-1	1	T20	3.86	25	35
475-TR25-1	1	T25	4.43	25	35
475-TR27-1	1	T27	4.99	25	35
475-TR30-1	1	T30	5.52	25	40
475-TR40-1	1	T40	6.65	25	50

1/4" BITS FOR HEXAGONAL SCREWS, 25 MM



x5

- Drive: 1/4" DIN 3126-C 6,3, ISO 1173
- Finish: sand blasting
- Material: high performance alloy steel
- Application: for all screw applications in trade and industry
- In plastic box of 5 pieces

R				
		mm	mm	g
475-H3-1	1	3	25	30
475-H4-1	1	4	25	35
475-H5-1	1	5	25	40
475-H6-1	1	6	25	45

TORSION BIT FOR PHILLIPS HEAD SCREWS, 25 MM



x10

- Drive: 1/4" DIN 3126-C 6,3, ISO 1173
- Finish: steel grey surface coated with clear lacquer for rust protection
- Material: high performance alloy steel
- Application: torsion bits are suitable for hard material applications
- Torsion zone that absorbs torque peaks avoiding premature wear and tear and improving service life
- In plastic box of 10 pieces

Part No.	Box	Icon	Length (mm)	Weight (g)
475T-PH1-1	1	PH-1	25	30
475T-PH2-2	1	PH-2	25	40
475T-PH3-2	1	PH-3	25	40

TORSION BIT FOR POZIDRIV HEAD SCREWS, 25 MM



x10

- Drive: 1/4" DIN 3126-C6.3,ISO 1173
- Finish: steel grey surface coated with clear lacquer for rust protection
- Material: high performance alloy steel
- Application: torsion bits are suitable for hard material applications
- Torsion zone that absorbs torque peaks avoiding premature wear and tear and improving service life
- In plastic box of 10 pieces

Part No.	Box	Icon	Length (mm)	Weight (g)
475T-PZ1-1	1	PZ-1	25	30
475T-PZ2-2	1	PZ-2	25	40
475T-PZ3-2	1	PZ-3	25	40

DIAMOND BIT FOR PHILLIPS HEAD SCREWS, 25 MM



x5

- Drive: 1/4" DIN 3126-C 6,3, ISO 1173
- Finish: gold coloured diamond coating
- Material: high performance alloy steel
- Application: high performance in any application
- Minimises the cam-out effect reducing "down-time"
- Reduces wear of bit and screw
- Torsion zone that absorbs torque peaks avoiding premature wear and tear and improving service life
- In plastic box of 5 pieces

Part No.	Box	Icon	Length (mm)	Weight (g)
475D-PH1-1	1	PH-1	25	30
475D-PH2-1	1	PH-2	25	40
475D-PH3-1	1	PH-3	25	40

DIAMOND BIT FOR POZIDRIV HEAD SCREWS, 25 MM



x5

- Drive: 1/4" DIN 3126-C 6,3, ISO 1173
- Finish: gold coloured diamond coating
- Material: high performance alloy steel
- Application: high performance in any application
- Minimises the cam-out effect reducing "down-time"
- Reduces wear of bit and screw
- Torsion zone that absorbs torque peaks avoiding premature wear and tear and improving service life
- In plastic box of 5 pieces

Part No.	Box	Icon	Length (mm)	Weight (g)
475D-PZ1-1	1	PZ-1	25	30
475D-PZ2-1	1	PZ-2	25	40
475D-PZ3-1	1	PZ-3	25	40



1/4" BITS

1/4" POWER MAGNETIC NUT DRIVER, METRIC



- Drive: 1/4" DIN 3126-E 6,3, ISO 1173
- Finish: sand blasting
- Material: high performance alloy steel
- Application: for all screw applications in trade and industry
- With strong magnet
- Hexagon socket
- In plastic holder (1 piece)

R	Box	mm	Hex	Ø mm	L mm	g
474M-5.5-1	1	5.5	1/4"	11.5	50	25
474M-6-1	1	6	1/4"	11	50	21
474M-7-1	1	7	1/4"	12	50	28
474M-8-1	1	8	1/4"	12.5	50	24
474M-9-1	1	9	1/4"	13.5	50	31
474M-10-1	1	10	1/4"	15.5	50	36
474M-11-1	1	11	1/4"	18.4	50	30
474M-12-1	1	12	1/4"	14.5	50	34
474M-13-1	1	13	1/4"	17	50	40

1/4" POWER MAGNETIC NUT DRIVER SET



- Drive: 1/4" DIN 3126 E 6.3, ISO 1173
- Finish: sand blasting
- Material: high performance alloy steel
- Application: for all screw applications in trade and industry
- With strong magnet
- Hexagon socket. In blister packaging

R	Box	Box X	g
474M-5-H	1	5	134

474M-5.5-1, 474M-7-1, 474M-8-1, 474M-10-1, 474M-13-1

1/4" POWER MAGNETIC NUT DRIVER, INCHES



- Drive: 1/4" DIN 3126-E 6,3, ISO 1173
- Finish: sand blasting
- Material: high performance alloy steel
- Application: for all screw applications in trade and industry
- With strong magnet
- Hexagon socket
- In plastic holder (1 piece)

R	Box	Hex	Hex	Ø mm	L mm	g
474M-1/4-1	1	1/4"	1/4"	11	50	21
474M-3/8-1	1	3/8"	1/4"	14.3	50	31

1/4" POWER NUT DRIVER WITH RETAINING RING



- Drive: 1/4" DIN 3126-E 6,3, ISO 1173
- Finish: sand blasting
- Material: high performance alloy steel
- Application: for all screw applications in trade and industry
- Hexagon socket
- In plastic holder (1 piece)

R	Box	Hex	Hex	Ø mm	L mm	g
474MR-8-1	1	8	1/4"	12.5	50	24
474MR-10-1	1	10	1/4"	13.5	50	36

ADAPTOR 1/4", 25 MM



- Drive: 1/4" DIN 3126-A 6.3, ISO 1173
- Finish: black finish
- Material: high performance alloy steel
- Hexagonal male to square female DIN3120
- In plastic bag (1 piece)
- Retail package

IRIMO	Box	Circle	Hexagon	Length (mm)	Weight (g)
475A-25-1	1	1/4"	1/4"	25	5

ADAPTOR 1/4", 50 MM



- Drive: 1/4" DIN 3126-A 6.3, ISO 1173
- Finish: black finish
- Material: high performance alloy steel
- Hexagonal male to square female DIN3120
- In plastic holder (1 piece)

IRIMO	Box	Circle	Hexagon	Length (mm)	Weight (g)
475A-50-1	1	1/4"	1/4"	50	18
475A-50-1/2-1	1	1/2"	1/4"	50	25

UNIVERSAL HOLDER 1/4"



- Drive: 1/4" DIN 3126-E 6.3, ISO 1173
- Finish: black finish
- Material: high performance alloy steel
- With strong magnet
- DIN 3126 D 6,3
- In plastic holder (1 piece)

IRIMO	Box	Circle	Hexagon	Length (mm)	Weight (g)
475A-M-50-1	1	1/4"	1/4"	50	20
475A-M-75-1		1/4"	1/4"	75	35
475A-M-150-1	1	1/4"	1/4"	150	47

QUICK RELEASE BIT HOLDER 1/4"



- Drive: DIN 3126-E 6.3, ISO 1173
- Material: high performance alloy steel
- DIN 3126 D 6,3
- With permanent magnet
- In plastic holder (1 piece)

IRIMO	Box	Circle	Hexagon	Ø (mm)	Length (mm)	Weight (g)
475A-60QR-1	1	1/4"	1/4"	14	60	15
475A-75QR-1	1	1/4"	1/4"	14	75	33



1/4" BITS SETS

1/4" BITS SETS, 32 pieces



- Drive: 1/4" DIN 3126-C 6,3, ISO 1173
- Finish: sand blasting
- Material: high performance alloy steel
- Display: 475-32-8 Disp 8 sets in blister packaging

Part No.	Box	Case	Dimensions (mm)	Weight (g)	Icons
475-32-1	1	32	30x105x65	275	
475-32-8DISP	1	8	360x340x260	2.240	
475-4.5-1, 475-4-1, 475-5.5-1					
2x 475-PH1-1, 2x 475-PH2-1, 2x 475-PH3-1					
475-PH2G-1					
2x 475-PZ1-1, 2x 475-PZ2-1, 2x 475-PZ3-1					
475-T10-1, 2x 475-T15-1, 2x 475-T20-1, 2x 475-T25-1, 475-T27-1, 2x 475-T30-1, 475-T40-1					
475-H3-1, 475-H4-1, 475-H5-1, 475-H6-1					
475A-25-1					
105-48-1					
475A-60QR-1					

1/4" BITS SETS, 32 pieces



- Bits set of 32 pieces: 30 bits, 1 magnetic quick release bit holder and bit holding screwdriver for interchangeable bits
- 1/4" hexagon drive. DIN 3126, ISO 1173, style C 6.3
- Lock-in type system for easy and safety lock, magnetic. The bit stays caught until the release is driven
- Robust and tough bits
- Quick release bit holder with strong magnet (style E 6.3)
- Sand blasting finish bits
- Robust plastic case with hanger. Transparent lid
- For universal use
- High performance alloy steel
- In blister packaging

Part No.	Box	Case	Dimensions (mm)	Weight (g)	Icons
475-32A-1	6	32	153x35x100	375	
475A-60QR-1					
475-4.5-1, 475-5.5-1, 475-6.5-1					
3x 475-PH1-1, 3x 475-PH2-1, 3x 475-PH3-1					
3x 475-PZ1-1, 3x 475-PZ2-1, 3x 475-PZ3-1					
475-H4-1, 475-H5-1, 475-H6-1					
475-T10-1, 475-T15-1, 475-T20-1, 475-T25-1, 475-T30-1, 475-T40-1					



1/4" TORX® BITS SET



- Bits set of 9 pieces: 8 bits and 1 magnetic quick release bit holder
- 1/4" hexagon drive. DIN 3126, ISO 1173, style C 6.3
- Robust and tough bits
- Quick release bit holder with strong magnet (style E 6.3)
- Sand blasting finish bits
- The small size of the set is ideal to be carried in a pocket. Easy to open and close
- For universal use
- High performance alloy steel
- In blister packaging

IRIMO	Box	Blister	mm	g
475-9-1	1	9	40x20x97	129
475A-60QR-1				
475-T10-1, 475-T15-1, 2x 475-T20-1, 2x 475-T25-1, 475-T30-1, 475-T40-1				

1/4" BITS SETS, 61 pieces



- Drive: 1/4" DIN 3126-C 6,3, ISO 1173
- Finish: sand blasting
- Material: high performance alloy steel
- In blister packaging

IRIMO	Box	Blister	mm	g
475-61-1	1	61	35 x 148 x 112	549
475-4.5-1, 475-4-1, 475-5.5-1, 475-6.0-1, 475-6.5-1, 475-8.0-1				
475-PH0-1, 2x 475-PH1-1, 3x 475-PH2-1, 2x 475-PH3-1				
2x 475-PH2G-1				
475-PZ0-1, 2x 475-PZ1-1, 3x 475-PZ2-1, 2x 475-PZ3-1				
475-T6-1, 475-T7-1, 475-T8-1, 475-T9-1, 2x 475-T10-1, 2x 475-T15-1, 3x 475-T20-1, 2x 475-T25-1, 2x 475-T27-1, 2x 475-T30-1, 2x 475-T40-1				
475-TR10-1, 475-TR15-1, 475-TR20-1, 475-TR25-1, 475-TR27-1, 475-TR30-1, 475-TR40-1				
475-H3-1, 475-H4-1, 475-H5-1, 475-H6-1				
475A-25-1				
R-1, R-2, R-3				
475A-60QR-1				

PRECISION SCREWDRIVER SET FOR PRECISION ENGINEERING AND ELECTRONICS APPLICATIONS

RATCHETING BIT HOLDER PRECISION SCREWDRIVER WITH 17 PIECES BITS



- Bits drive: 5/32" DIN 3126-C 4, ISO 1173
- Bits: made of chrome-vanadium steel, durable and high precision
- Handle: 2-component handle
- The rotating head allows an easy and accurate driving
- Magnetic blade secures bit in screwdriver
- Smooth ratcheting stroke: Three position ratchet mechanism: forward, reverse and neutral
- In blister packaging

IRIMO	Box	Blister	mm	g
471-18-1	1	17	35 x 95 x 130	220
x3	SL: 1-1.5-2 mm	x3		PH000-PH00-PH0
x5	T2-T3-T4-T5-T6	x2		0.8-1.2
x2	Y 2.0-3.0	x1		U 2.6
x1	2.3	x1		

5/16" BITS

5/16" BITS FOR SLOTTED SCREWS



x2

- Drive: 5/16" DIN 3126-C 8, ISO 1173
- Finish: zinc phosphated
- Material: high performance alloy steel
- In plastic bag of 2 pieces
- Retail package

Part No.	Qty	W mm	L mm	Overall L mm	Wt g
470-5.5-1	1	1.0	5.5	36	18
470-6.5-1	1	1.2	6.5	36	20
470-8.0-1	1	1.2	8.0	36	22
470-10.0-1	1	1.6	10.0	36	30
470-12.0-1	1	2.0	12.0	36	36
470-14.0-1	1	2.5	14.0	36	38

5/16" BITS FOR PHILLIPS SCREWS



x2

- Drive: 5/16" DIN 3126-C 8, ISO 1173
- Finish: zinc phosphated
- Material: high performance alloy steel
- In plastic bag of 2 pieces
- Retail package

Part No.	Qty	Drive	Overall L mm	Wt g
470-PH1-1	1	PH-1	36	22
470-PH2-1	1	PH-2	36	24
470-PH3-1	1	PH-3	36	25
470-PH4-1	1	PH-4	36	28

5/16" BITS FOR HEXAGONAL SCREWS



x2

- Drive: 5/16" DIN 3126-C 8, ISO 1173
- Finish: zinc phosphated
- Material: high performance alloy steel
- In plastic bag of 2 pieces
- Retail package

Part No.	Qty	W mm	Overall L mm	Wt g
470-H4-1	1	4	36	25
470-H5-1	1	5	36	26
470-H6-1	1	6	36	27
470-H7-1	1	7	36	28
470-H8-1	1	8	36	29
470-H10-1	1	10	36	36

5/16" BITS FOR TORX® SCREWS



x2

- Drive: 5/16" DIN 3126-C 8, ISO 1173
- Finish: zinc phosphated
- Material: high performance alloy steel
- In plastic bag of 2 pieces
- Retail package

Part No.	Qty	Drive	W mm	Overall L mm	Wt g
470-T20-1	1	T20	3.86	36	21
470-T25-1	1	T25	4.43	36	22
470-T27-1	1	T27	4.99	36	24
470-T30-1	1	T30	5.52	36	24
470-T40-1	1	T40	6.65	36	27
470-T45-1	1	T45	7.82	36	27
470-T50-1	1	T50	8.83	36	27
470-T55-1	1	T55	11.22	36	28

5/16" IMPACT SCREWDRIVER

5/16" IMPACT SCREWDRIVER



- To turn frozen screws
- Converts hammer action on turning driving
- Hammer action guarantees that the bit will remain against the screw
- Square drive 1/2". Bit size 5/16"
- Reversible by positioning the adaptor

Part No.	Box	L mm	C mm	A mm	L1 mm	g
470011	1	125	33	24	40	650

5/16" IMPACT SCREWDRIVER ADAPTOR



- Finish: Chrome-plated
- 1/2" square drive
- For 5/16" bits
- With retaining ring

Part No.	Box	L mm	g
470051	1	40	54

5/16" IMPACT DRIVER BIT SET



- 1 Impact screwdriver, 1/2" square drive
- 1 Bit holding adaptor for screwdriver bits, 5/16" hexagon and 1/2" square drive
- 18 bits of 5/16"
- In black metal box

Part No.	Box	Dimensions	g
471011	1	197 x 70 x 45	1.280
470-8.0-1, 470-10.0-1, 470-12.0-1			
470-PH2-1, 470-PH3-1, 470-PH4-1			
470-H4-1, 470-H5-1, 470-H6-1, 470-H7-1, 470-H8-1, 470-H10-1			
470-T25-1, 470-T27-1, 470-T30-1, 470-T40-1, 470-T45-1, 470-T50-1			
470011			



10 MM BITS

10 MM BITS FOR HEXAGONAL SCREWS



- Drive: 10 mm
- Finish: zinc phosphated
- Material: high performance alloy steel
- In plastic bag of 1 piece

Part No.	Box	Tip (mm)	Length (mm)	Weight (g)
T49H4	1	4	30	5
T49H5	1	5	30	6.5
T49H6	1	6	30	7
T49H7	1	7	30	7
T49H8	1	8	30	7
T49H10	1	10	30	7
T49H12	1	12	30	12
T49H14	1	14	30	14
T49H4L	1	4	75	20
T49H5L	1	5	75	20
T49H6L	1	6	75	20
T49H7L	1	7	75	20
T49H8L	1	8	75	20
T49H10L	1	10	75	20
T49H12L	1	12	75	20
T49H10XL	1	10	115	75

10 MM BITS FOR TORX® SCREWS



- Drive: 10 mm
- Finish: zinc phosphated
- Material: high performance alloy steel
- In plastic bag of 1 piece

Part No.	Box	Tip (mm)	Length (mm)	Weight (g)	
T49T20	1	T20	3.84	30	6.5
T49T25	1	T25	4.4	30	6.5
T49T27	1	T27	4.96	30	6.5
T49T30	1	T30	5.49	30	6.5
T49T40	1	T40	6.6	30	6.5
T49T45	1	T45	7.7	30	6.5
T49T50	1	T50	8.79	30	6.5
T49T55	1	T55	11.17	30	6.5
T49T60	1	T60	13.2	30	6.5
T49T20L	1	T20	3.84	75	20
T49T25L	1	T25	4.4	75	20
T49T27L	1	T27	4.96	75	20
T49T30L	1	T30	5.49	75	20
T49T40L	1	T40	6.6	75	20
T49T45L	1	T45	7.7	75	20
T49T50L	1	T50	8.79	75	20
T49T55L	1	T55	11.17	75	20
T49T60L	1	T60	13.2	75	20
T49T55XL	1	T55	11.17	115	75

1/2" ADAPTOR FOR 10 MM BITS



- 1/2" Adaptor for 10 mm bits
- Finish: zinc phosphated
- Material: high performance alloy steel
- In plastic bag of 1 piece

Part No.	Box	Tip (mm)	L (mm)	D1 (mm)	D2 (mm)	Weight (g)
T4901	1	10	36	17	22	55

3/8" ADAPTOR FOR 10 MM BITS



- 3/8" Adaptor for 10 mm bits
- Finish: zinc phosphated
- Material: high performance alloy steel
- In plastic bag of 1 piece

Part No.	Box	Tip (mm)	L (mm)	D1 (mm)	D2 (mm)	Weight (g)
T4902	1	10	35	15	10	32

10 MM BITS FOR TORX® TAMPER SCREWS



- Drive: 10 mm
- Finish: zinc phosphated
- Material: high performance alloy steel
- In plastic bag of 1 piece

R			mm	mm	g
T49T20H	1	TR20	3.84	30	6.5
T49T25H	1	TR25	4.4	30	6.5
T49T27H	1	TR27	4.96	30	6.5
T49T30H	1	TR30	5.49	30	6.5
T49T40H	1	TR40	6.6	30	6.5
T49T45H	1	TR45	7.7	30	6.5
T49T50H	1	TR50	8.79	30	6.5
T49T55H	1	TR55	11.17	30	6.5
T49T60H	1	TR60	13.2	30	6.5
T49T20HL	1	TR20	3.84	75	20
T49T25HL	1	TR25	4.4	75	20
T49T27HL	1	TR27	4.96	75	20
T49T30HL	1	TR30	5.49	75	20
T49T40HL	1	TR40	6.6	75	20
T49T45HL	1	TR45	7.7	75	20
T49T50HL	1	TR50	8.79	75	20
T49T55HL	1	TR55	11.17	75	20
T49T60HL	1	TR60	13.2	75	20

10 MM SQUARE BITS



- Drive: 10 mm
- Finish: zinc phosphated
- Material: high performance alloy steel
- In plastic bag of 1 piece

R			mm	g
T49SQ8	1	8	30	17
T49SQ10	1	10	30	22

10 MM BITS FOR XZN SCREWS



- Drive: 10 mm
- Finish: zinc phosphated
- Material: high performance alloy steel
- In plastic bag of 1 piece

R			mm	g
T49M5	1	M5	30	6.5
T49M6	1	M6	30	7
T49M8	1	M8	30	7
T49M10	1	M10	30	8.5
T49M12	1	M12	30	10
T49M14	1	M14	30	20
T49M5L	1	M5	75	15
T49M6L	1	M6	75	15
T49M8L	1	M8	75	15
T49M10L	1	M10	75	15
T49M12L	1	M12	75	15



1/2" SOCKET DRIVERS

1/2" SOCKET DRIVERS FOR TORX® TAMPER SCREWS



- 1/2" socket drivers for TORX® tamper screws
- Finish: zinc phosphated
- Material: high performance alloy steel
- In plastic bag of 1 piece

Part No.	Qty	Code	Size	L mm	L1 mm	g
T49T30XL	1	TR30	1/2"	200	160	122
T49T40XL	1	TR40	1/2"	200	160	123
T49T45XL	1	TR45	1/2"	200	160	125
T49T70HL	1	TR70	1/2"	100	60	167
T49T80HL	1	TR80	1/2"	100	30	163

10 MM BITS SET, 31 pieces



- Drive: 10 mm
- Finish: zinc phosphated
- Material: high performance alloy steel
- In metal box

Part No.	Qty	Code	Dimensions	Weight
471151	1	31	37 x 195 x 105	1.270
T4901				
T49H5, T49H6, T49H6L, T49H8, T49H8L, T49H10, T49H10XL, T49H12, T49H14				
T49M5, T49M6, T49M8, T49M8L, T49M10, T49M10L, T49M12, T49M12L, T49M14				
T49T20, T49T25, T49T27, T49T30, T49T40, T49T45, T49T45L, T49T50, T49T55, T49T55XL				
T49SQ8, T49SQ10				

10 MM BITS SET, 49 pieces



- Drive: 10 mm
- Finish: zinc phosphated
- Material: high performance alloy steel
- In metal box

Part No.	Qty	Code	Dimensions	Weight
T49	1	49	60 x 325 x 195	3.600
T4901				
T4902				
T49T30XL, T49T40XL, T49T45XL, T49T70HL, T49T80HL				
T49H4, T49H4L, T49H5, T49H5L, T49H6, T49H6L, T49H7, T49H7L, T49H8, T49H8L, T49H10, T49H10L, T49H12, T49H12L				
T49M5, T49M5L, T49M6, T49M6L, T49M8, T49M8L, T49M10, T49M10L, T49M12, T49M12L				
T49T20H, T49T20HL, T49T25H, T49T25HL, T49T27H, T49T27HL, T49T30H, T49T30HL, T49T40H, T49T40HL, T49T45H, T49T45HL, T49T50H, T49T50HL, T49T55H, T49T55HL, T49T60H, T49T60HL				



08. STRIKING TOOLS

PUNCHES AND CHISELS

COLD CHISELS



- Chrome vanadium
- Standard: UNE 16567

R		L mm	S mm	A mm	g
501-150-1	25	150	18	10	133
501-175-1	25	175	21	11	192
501-200-1	25	200	22	12	243
501-250-1	20	250	25	13	357
501-300-1	25	300	26	14	552

FLAT COLD CHISELS

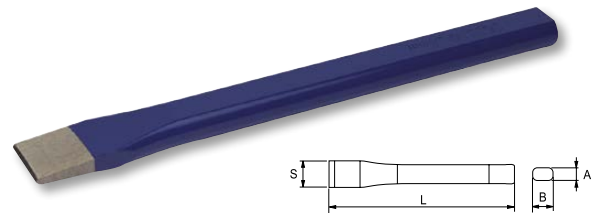

- Chrome molib. vanadium
- Finish: Lacquered, blue painted
- Flat oval shank
- Standard: DIN 7250

R		L mm	S mm	AxB mm	g
504-150-1	10	150	21	11x17	181
504-175-1	10	175	24	12x20	269
504-200-1	10	200	28	13x23	390
504-250-1	10	250	28	13x23	500
504-300-1	10	300	32	13x26	602

FLAT COLD CHISEL

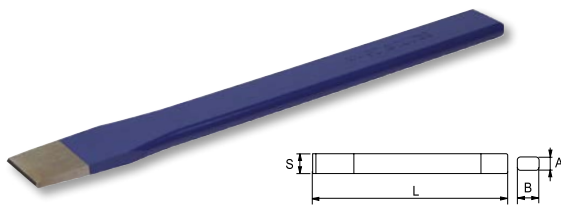

- Chrome molib. vanadium
- Finish: Lacquered, blue painted
- Flat oval shank

R		S mm	L mm	A mm	B mm	g
502-230-1	10	230	26	7	26	285

EXTRAFLAT COLD CHISEL

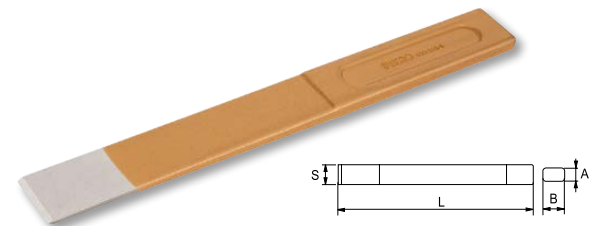

- Chrome molib. vanadium
- Flat oval shank

R		S mm	L mm	A mm	B mm	g
500-240-1	10	230	26	4	26	278

CAPE CHISELS

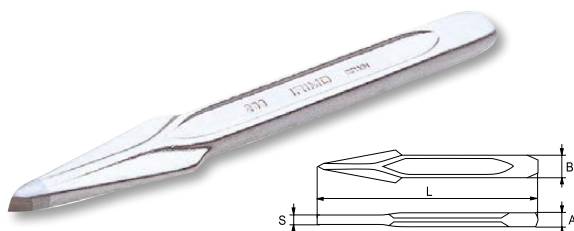

- Chrome vanadium
- Standard: UNE 16568

R		L mm	S mm	AxB mm	g
505-150-1	5	150	6.5	11x17	129
505-200-1	5	200	8.5	12x21	241
505-250-1	5	250	9.5	14x24	404

FLAT CAPE CHISELS

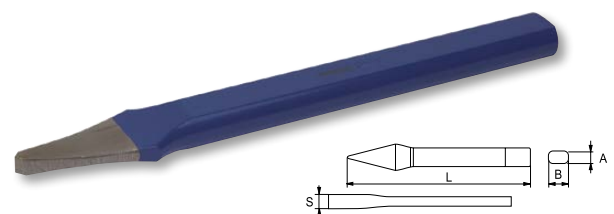

- Chrome molib. vanadium
- Finish: Lacquered, blue painted
- Flat oval shank
- Standard: DIN 7250

R		L mm	S mm	AxB mm	g
506-150-1	10	150	6	11x17	152
506-175-1	10	175	7	12x20	231
506-200-1	10	200	8	13x23	335

ROUND CENTRE PUNCHES

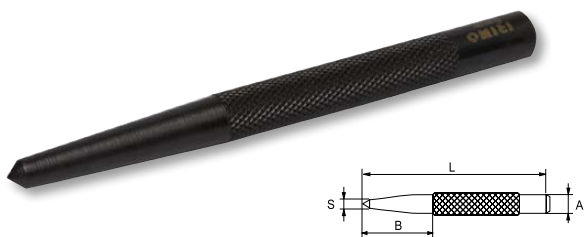

- Black finish
- Standard: UNE 16574

E	Icon	S mm	L mm	A mm	B mm	g
511-100-1		25	2.5	100	8	35
511-105-1		25	4	105	8	35
511-110-1		25	5	110	8	40
511-115-1		25	6	115	10	45
511-130-1		20	8	130	12	50

OCTAGONAL CENTRE PUNCHES



- Chrome molib. vanadium
- Finish: Lacquered, blue painted
- Octagonal shank
- Standard: DIN 7250

E	Icon	S mm	L mm	A mm	B mm	g
512-010-1		25	4	120	10	40
512-012-1		25	5	120	12	40

ROUND CENTRE PUNCH SETS



E	Icon	Icon	Icon	g
511-91-4		X	2.5 - 4 - 6 - 8 mm	234
511-92-4			2.5 - 4 - 5 - 6 - 8 mm	275

ROUND TAPER PUNCHES

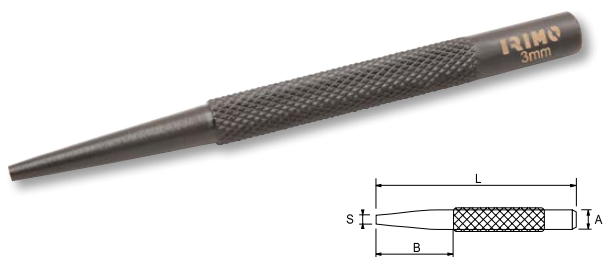

- Black finish
- Standard: UNE 16576

E	Icon	S mm	L mm	A mm	B mm	g
513-002-1		25	2	100	8	35
513-003-1		25	3	100	8	35
513-004-1		25	4	115	10	45
513-005-1		25	5	115	10	45
513-006-1		20	6	130	12	50
513-008-1		20	8	150	12	55
513-010-1		20	10	170	14	60

OCTAGONAL TAPER PUNCHES

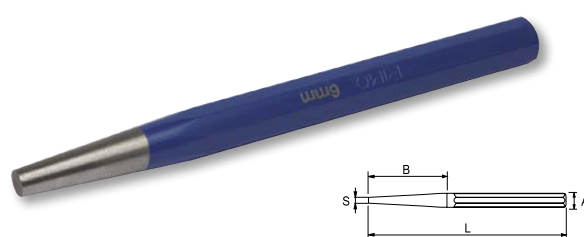

- Chrome molib. vanadium
- Finish: Lacquered, blue painted
- Octagonal shank
- Standard: DIN 6458

E	Icon	S mm	L mm	A mm	B mm	g
514-002-1		25	2	120	10	40
514-003-1		25	3	120	10	40
514-004-1		25	4	120	10	40
514-005-1		25	5	120	10	40
514-006-1		25	6	120	12	40



PUNCHES AND CHISELS

ROUND TAPER PUNCH SET



IRIMO	Box	Case	Diagram	Weight
513-91-4	1	5	2 - 4 - 6 - 8 - 10 mm	502
513-92-4	1	7	2 - 3 - 4 - 5 - 6 - 8 - 10 mm	602

OCTAGONAL TAPER PUNCH SETS



IRIMO	Box	Case	Dimensions	Weight
519-91-4	1	6	150x80x12	409
2-3-4-5-6 mm				
4 mm				

ROUND PARALLEL PIN PUNCHES

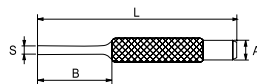

- Black finish
- Standard: UNE 16575

IRIMO	Box	S mm	L mm	A mm	B mm	Weight
515-002-1	25	2	100	8	28	29
515-003-1	25	3	100	8	28	30
515-004-1	25	4	100	8	28	31
515-005-1	25	5	115	10	33	53
515-006-1	25	6	115	10	33	55
515-007-1	25	7	115	10	33	58
515-008-1	20	8	130	12	43	91
515-009-1	20	9	130	12	43	96
515-010-1	20	10	130	14	53	143

OCTAGONAL PARALLEL PIN PUNCHES

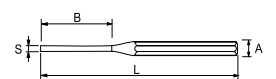

- Chrome molib. vanadium
- Finish: Lacquered, blue painted
- Octagonal shank
- Standard: DIN 6450

IRIMO	Box	S mm	L mm	A mm	B mm	Weight
516-002-1	20	2	150	10	35	63
516-003-1	20	3	150	10	40	63
516-004-1	20	4	150	10	50	63
516-005-1	20	5	150	10	50	64
516-006-1	20	6	150	10	50	70
516-008-1	20	8	150	12	55	106

ROUND PARALLEL PIN PUNCH SET



515-91-4	1	9	2-3-4-5-6-7-8-9-10 mm	622

OCTAGONAL PARALLEL PIN PUNCH SET



519-92-4	1	6	2-3-4-5-6-8 mm	409

ROUND PARALLEL PIN PUNCHES, LONG SERIES

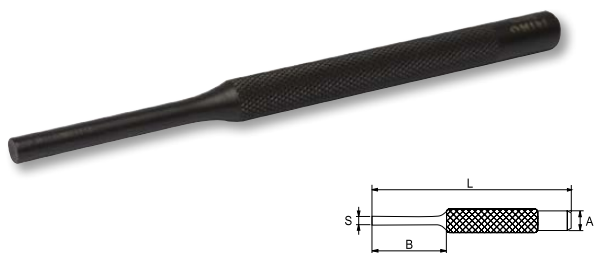

- Black finish
- Standard: UNE 16575

		S mm	L mm	A mm	B mm	
517-120-1	25	2	120	8	30	33
517-130-1	25	3	130	8	40	35
517-135-1	25	4	135	8	45	37
517-140-1	25	5	140	10	50	60
517-145-1	20	6	145	10	55	64
517-150-1	20	8	150	12	60	100

OCTAGONAL PARALLEL PIN PUNCHES, LONG SERIES

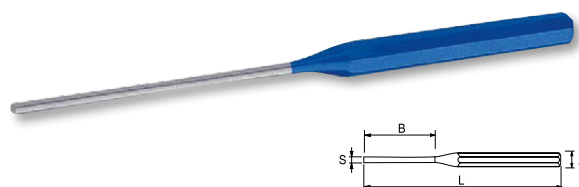

- Finish: Lacquered, blue painted
- Octagonal shank
- Long length

		S mm	L mm	A mm	B mm	
518-004-1	20	4	175	10	80	61
518-006-1	20	6	175	10	80	72

ROUND PARALLEL PIN PUNCH SETS, LONG SERIES



517-91-4	1	6	2-3-4-5-6-8 mm	355



PUNCHES AND CHISELS

ELECTRICIAN'S COLD CHISELS

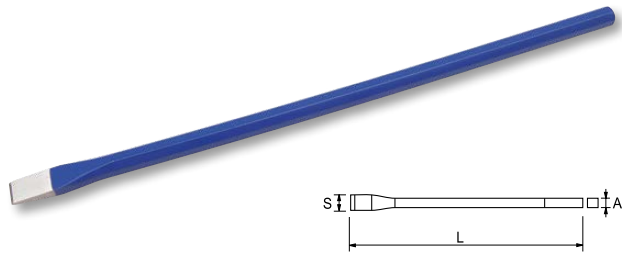

- Finish: Lacquered, blue painted
- Chrome molib. vanadium

IRIMO	Box	L mm	S mm	A mm	g
503-200-1	20	200	12	8	93
503-250-1	20	250	12	8	119
503-300-1	20	300	12	8	142

SET



IRIMO	Box	Box	Box	g
519-93-4	1	6	160x85x12	600
504-150-1				
506-150-1				
512-010-1				
514-003-1, 514-004-1				
516-005-1				

ENGINEERS SCRIBERS



- Suitable for marking on hard surfaces
- 150 mm long

IRIMO	Box	L mm	g
511501	1	150	39

WRECKING BARS



- Heavy duty tool for striking tasks
- Designed for a good penetration in very narrow places and nails provided
- With special designed claw areas to facilitate nail extraction
- Smooth finishing and high quality paint to get a comfortable use

IRIMO	Box	Ø mm	L mm	g
WB-300-2	1	14	346	450
WB-500-2	1	16	487	1.100
WB-625-2	1	17	685	1.450
WB-710-2	1	17	704	1.950
WB-900-2	1	20	890	2.850

HAMMERS

CURVED CLAW HAMMER WITH WOODEN HICKORY HANDLE



- Handle fitting to hammer head with wedges

Q	Box	oz	g	A mm	B mm	L mm	g
520-41-2	6	16	450	29	130	330	710
520-61-2	6	20	560	30	140	333	820

SPARE WOODEN HICKORY HANDLE FOR CURVED CLAW HAMMERS



- Served with corresponding wedges

Q	Box	g	g	g
520-42-2	12		520-41-2 / 520-61-2	160

SPANISH TYPE CURVED CLAW HAMMER WITH WOODEN HICKORY HANDLE



- Handle has conical fitting to the hammer head

Q	Box	g	A mm	B mm	L mm	g
521-51-2	6	350	28.2	107.3	330	500
521-71-2	6	475	31.1	118.3	330	625
521-81-2	6	550	31.6	125.5	330	700

SPARE WOODEN HICKORY HANDLE FOR SPANISH TYPE CURVED CLAW HAMMERS



- Conical hickory handle

Q	Box	g	g	g
521-52-2	18		521-51-2 / 521-71-2	160
521-82-2	18		521-81-2	160

CURVED CLAW HAMMER WITH FIBREGLASS HANDLE



- Handle specially glued to hammer head
- Trimaterial handle with fiberglass core and covered with polypropylene and elastomere for an effective grip

Q	Box	oz	g	A mm	B mm	L mm	g
520-43-2	6	16	450	29	130	330	710
520-63-2	6	20	560	30	140	333	820

STUBBY CLAW HAMMER



- Handle specially glued to hammer head
- Trimaterial handle with fiberglass core and covered with polypropylene and elastomere for an effective grip
- Magnet on the head for holding the nail

Q	Box	oz	g	A mm	B mm	L mm	g
520-13S-1	6	8	227	23	105	160	300

SPANISH TYPE CURVED CLAW HAMMER WITH FIBREGLASS HANDLE



- Handle has conical fitting to hammer head
- Conical trimaterial handle with fiberglass core and covered with polypropylene and elastomere for an effective grip

Q	Box	g	A mm	B mm	L mm	g
521-53-2	6	350	28.2	107.3	330	500
521-73-2	6	475	31.1	118.3	330	625
521-83-2	6	550	31.6	125.5	327	700

SPARE FIBREGLASS HANDLE FOR SPANISH TYPE CURVED CLAW HAMMERS



- Conical trimaterial handle with fiberglass core and covered with polypropylene and elastomere for an effective grip

Q	Box	g	g	g
521-54-2	18		521-53-2 / 521-73-2	160
521-84-2	18		521-83-2	160



HAMMERS

JOINER'S HAMMER WITH WOODEN HICKORY HANDLE



- Handle fitted with wedges to hammer head

€	📦	🔧	A mm	B mm	L mm	g
522-21-2	12	170	20	91	282	270
522-31-2	6	270	25	107	291	380
522-41-2	6	460	30	120	311	680

GERMAN DIN HAMMER WITH WOODEN HICKORY HANDLE



- Handle wedged to hammer head

€	📦	🔧	A mm	B mm	L mm	g
525-11-2	6	100	17	90	270	250
525-21-2	6	200	19	95	280	280
525-31-2	6	300	23	105	300	420
525-41-2	6	500	27	118	320	650
525-61-2	6	800	33	130	350	990
525-71-2	4	1.000	36	135	360	1.220
525-81-2	4	1.500	42	145	380	1.790
525-91-2	4	2.000	45	150	380	2.300

SPARE WOODEN HICKORY HANDLE FOR JOINER'S HAMMERS



- Served with corresponding wedges

€	📦	🔧	g
522-22-2	18	522-21-2	63
522-32-2	18	522-31-2	100
522-42-2	18	522-41-2	140

SPARE WOODEN HICKORY HANDLE FOR GERMAN DIN HAMMERS



- Served with corresponding wedges

€	📦	🔧	g
525-12-2	12	525-11-2	96
525-22-2	12	525-21-2	86
525-32-2	12	525-31-2	93
525-42-2	12	525-41-2	136
525-62-2	12	525-61-2	212
525-72-2	12	525-71-2	260
525-82-2	12	525-81-2	298
525-92-2	12	525-91-2	344

JOINER'S HAMMER WITH FIBREGLASS HANDLE



- Handle specially glued to hammer head
- Trimaterial handle with fiberglass core and covered with polypropylene and elastomere for an effective grip

€	📦	🔧	A mm	B mm	L mm	g
522-23-2	12	170	20	91	282	270
522-33-2	6	270	25	107	291	380
522-43-2	6	460	30	120	311	680

GERMAN DIN HAMMER WITH FIBREGLASS HANDLE



- Handle specially glued to hammer head
- Trimaterial handle with fiberglass core and covered with polypropylene and elastomere for an effective grip

€	📦	🔧	A mm	B mm	L mm	g
525-43-2	6	500	27	118	330	735

RIVOIR HAMMER WITH WOODEN HICKORY HANDLE



- Handle wedged to hammer head

E	Box	g	A mm	B mm	L mm	g
526-31-2	4	250	25	81.5	265	350
526-41-2	4	400	30	92	280	520
526-51-2	4	630	35	103	300	800
526-61-2	4	800	40	110	330	1.000
526-71-2	4	1.150	45	124	350	1.400
526-91-2	4	2.000	50	138	380	2.250

SPARE WOODEN HICKORY HANDLE FOR RIVOIR HAMMERS



- Served with corresponding wedges

E	Box	g	
526-32-2	12	526-31-2	93
526-42-2	12	526-41-2	136
526-52-2	12	526-51-2	212
526-62-2	12	526-61-2	260
526-72-2	12	526-71-2	298
526-92-2	12	526-91-2	344

RIVOIR HAMMER WITH FIBREGLASS HANDLE



- Handle specially glued to hammer head
- Trimaterial handle with fiberglass core and covered with polypropylene and elastomere for an effective grip

E	Box	g	A mm	B mm	L mm	g
526-53-2	6	630	35	103	330	630

BALL PEIN HAMMER WITH WOODEN HICKORY HANDLE



- Handle wedged to hammer head

E	Box	oz	g	A mm	B mm	L mm	g	
527-31-2	6	B	12	340	27	87	318	440
527-41-2	6	C	16	455	30	97	318	560
527-51-2	6	D	20	560	33	106	318	720
527-61-2	6	E	24	680	35	116	343	920
527-71-2	6	F	32	910	37	127	343	1.148
527-81-2	6	G	40	1.135	38	134	378	1.400
527-91-2	6	H	48	1.360	40	144	385	1.640

SPARE WOODEN HICKORY HANDLE FOR BALL PEIN HAMMERS



- Served with corresponding wedges

E	Box	g	
527-32-2	18	527-31-2 (B) / 527-41-2 (C) / 527-51-2 (D)	100
527-52-2	12	527-61-2 (E) / 527-71-2 (F)	160
527-82-2	12	527-81-2 (G) / 527-91-2 (H)	220

BALL PEIN HAMMER WITH FIBREGLASS HANDLE



- Handle specially glued to hammer head
- Trimaterial handle with fiberglass core and covered with polypropylene and elastomere for an effective grip

E	Box	oz	g	A mm	B mm	L mm	g	
527-33-2	6	B	12	340	27	90	317	500
527-43-2	6	C	16	455	30	100	320	600
527-53-2	6	D	20	560	33	108	324	760
527-63-2	6	E	24	680	35	120	335	920
527-73-2	6	F	32	910	37	131	337	1.148
527-83-2	6	G	40	1.135	38	139	387	1.400
527-93-2	6	H	48	1.360	40	148	390	1.640



HAMMERS

STONING HAMMER WITH WOODEN HICKORY HANDLE



- Handle wedged to the club hammer head

€	Box	g	A mm	B mm	L mm	g
530-03-2	6	700	35	110	280	800
530-05-2	6	1.000	38	120	280	1.200
530-07-2	6	1.250	43	135	280	1.400

STONING HAMMER WITH WOODEN HICKORY HANDLE

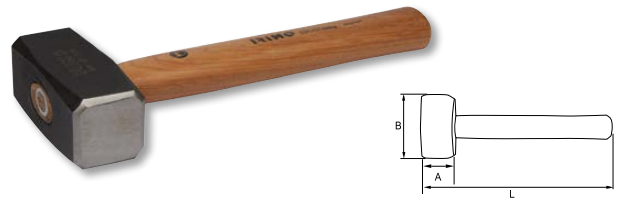

- Handle wedged to club hammer head

€	Box	g	A mm	B mm	L mm	g
531-05-2	6	1.000	40	95	260	1.155
531-07-2	6	1.250	43	100	260	1.405
531-08-2	4	1.500	45	110	280	1.675
531-09-2	2	2.000	50	120	300	2.235

SPARE WOODEN HICKORY HANDLE FOR STONING HAMMERS



- Served with corresponding wedges

€	Box	Wedge	g
530-13-2	12	530-03-2	145
530-15-2	12	530-05-2 / 530-07-2	159

SPARE WOODEN HICKORY HANDLE FOR STONING HAMMERS



- Served with corresponding wedges

€	Box	Wedge	g
531-15-2	12	531-05-2	165
531-17-2	12	531-07-2	168
531-18-2	12	531-08-2	205
531-19-2	12	531-09-2	231

BLACK RUBBER MALLET

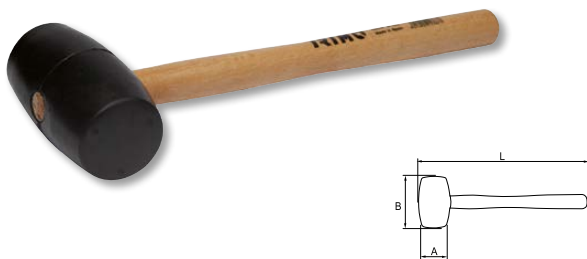

- Handle wedged to club hammer head

€	Box	A mm	B mm	L mm	g
529251	1	55	90	320	250
529261	1	65	115	340	440
529271	1	75	125	360	600
529291	1	90	139	360	720

ANTI-BOUNCE NYLON FACED HAMMERS



• Wooden handle

Q	Icon	S mm	A mm	L mm	g
529611	6	35	115	370	500
529621	6	50	120	390	1.000
529631	6	60	125	420	1.560



• Anti-bounce nylon tips

Q	Icon	A mm	L mm	g
529701	6	25	35	20
529711	6	28	50	50
529721	6	30	60	60



• Anti-bounce hammer handle

Q	Icon	Part	g
529801	1	529611	90
529811	1	529621	140
529821	1	529631	215

NYLON FACED HAMMERS



• Metal handle, rubber grip

Q	Icon	S mm	A mm	L mm	g
529021	6	28	80	255	325
529031	6	35	100	285	650
529041	6	44	125	300	1.105

NYLON FACED HAMMERS



• Wooden handle

Q	Icon	S mm	A mm	L mm	g
529151	6	22	65	215	145
529161	6	28	80	270	260
529171	6	35	100	295	500
529181	6	44	125	345	1.010
529191	6	55	140	380	1.480



• Spare tips for nylon faced hammers

Q	Icon	A mm	L mm	Ø mm	g
529061	10	12	22	8	10
529071	10	19	28	9	15
529081	10	22	35	10	20
529091	10	27	44	13	50
529101	10	32	55	16	80



• Spare handle for nylon faced hammers

Q	Icon	Part	g
529751	1	529151	50
529761	1	529161	70
529771	1	529171	100
529781	1	529181	150
529791	1	529191	170



CHISELS

CHISEL SET, 3 pieces



- General purpose bevel edge wood chisels
- Mono-material polypropylene handle
- High quality Cr-V 58-62 HRc steel blades hardened for long-lasting performance
- Ground blades
- Fitted with a tip protector

805-3-C	1	3	12, 18, 25 mm	589

WOOD CARVING SET, 6 pieces



- Carving chisel set, 6 pieces
- Rubberwood handle
- High quality chrome vanadium steel blades
- Hardness at least up to 55 HRc for durability and easy maintenance
- Black oxide finish and anti-rust oil for protection of rust
- Length of chisels: 160 mm

806-6-B	1	6	160	221

	1 piece square chisel, 12 mm
	1 piece sken chisel, 12 mm
	1 piece curved gouge, 6.5 mm
	1 piece straight gouge, 5 mm
	1 piece curved flat, 5 mm
	1 piece curved U tool, 12 mm



09. PLIERS – SCISSORS & KNIVES

PLIERS

SIDE CUTTING PLIERS

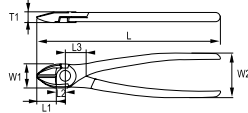

- High performance steel
- Hardness: edges hardened to 60-65 HRc
- Standard: ISO 5749
- Cutting capacity:
 - 1- Bronze wire: 0.50 mm
 - 2- Medium hard wire: 1.60 mm

Code	Material	L mm	L1 mm	L2 mm	L3 mm	W1 mm	W2 mm	T1 mm	1 mm	2 mm	g
624-140-1	5	142	20.5	6	12	18.6	50	10	Ø 0.5 mm	Ø 1.6 mm	170
624-160-1	5	160	21.5	7	13	21.6	50	11.5	Ø 0.5 mm	Ø 1.6 mm	200
624-180-1	5	176	24.5	7	14	25.6	50	12.5	Ø 0.5 mm	Ø 1.6 mm	250

SIDE CUTTING PLIERS

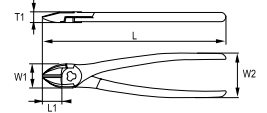

- High performance steel
- Hardness: edges at 60-65 HRc
- Standard: ISO 5749
- Cutting capacity:
 - 1- Bronze wire: 0.50 mm
 - 2- Medium hard wire: 1.80-2.00 mm

Code	Material	L mm	L1 mm	W1 mm	W2 mm	T1 mm	1 mm	2 mm	g
625-180-1	5	180	20.5	25.6	49	11.5	Ø 0.5 mm	Ø 1.8 mm	280
625-200-1	5	206	23	30	54	12	Ø 0.5 mm	Ø 2.0 mm	320

COMBINATION PLIERS

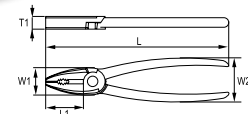

- High performance steel
- Hardness: edges at 58-65 HRc
- Standard: ISO 5746
- Cutting capacity:
 - 1- Bronze wire: 1.00 mm
 - 2- Medium hard wire: 1.60-2.00-2.50 mm

Code	Material	L mm	L1 mm	W1 mm	W2 mm	T1 mm	1 mm	2 mm	g
601-160-1	5	160	35	24	50	10	Ø 1.0 mm	Ø 1.6 mm	190
601-180-1	5	180	38	27	50	10	Ø 1.0 mm	Ø 2.0 mm	240
601-200-1	5	197	41.5	29.5	50	10	Ø 1.0 mm	Ø 2.5 mm	300

SNIPE NOSE PLIERS

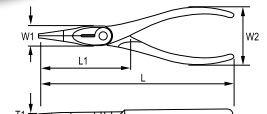

- High performance steel
- Hardness: edges at 58-65 HRc
- Standard: ISO 5745
- Cutting capacity:
 - 1- Bronze wire: 1.00 mm
 - 2- Medium hard wire: 1.60 mm

Code	Material	L mm	L1 mm	W1 mm	W2 mm	T1 mm	1 mm	2 mm	g
612-160-1	5	161	61.5	16.5	49	10	Ø 1.0 mm	Ø 1.6 mm	140
612-200-1	5	201	78	18	50	10.5	Ø 1.0 mm	Ø 1.6 mm	180

SNIPE NOSE PLIERS BENT TIP

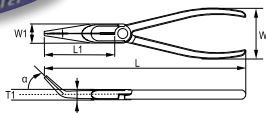

- High performance steel
- Hardness: edges at 58-65 HRc
- Angled at 45°
- Standard: ISO 5745
- Cutting capacity:
 - 1- Bronze wire: 1.00 mm
 - 2- Medium hard wire: 1.60 mm

Code	Material	L mm	L1 mm	W1 mm	W2 mm	T1 mm	α	1 mm	2 mm	g
613-160-1	5	158	48	18	50	9.0	45°	Ø 1.0 mm	Ø 1.6 mm	132
613-200-1	5	197	74	18	50	10.5	45°	Ø 1.0 mm	Ø 1.6 mm	180

FLAT NOSE PLIERS

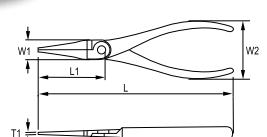

- High performance steel
- Hardness: 45-50 HRc
- Standard: ISO 5745

Code	Material	L mm	L1 mm	W1 mm	W2 mm	T1 mm	g
604-160-1	5	158	48	17	48	9	150
604-180-1	5	180	50	20	50	11	175

ROUND NOSE PLIERS

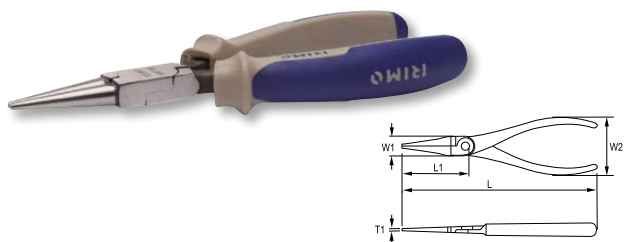

- High performance steel
- Hardness: 45-50 HRc
- Standard: ISO 5745

Code	Material	L mm	L1 mm	W1 mm	W2 mm	T1 mm	g
608-160-1	5	158	38	17	48	8.5	150

SLIP JOINT PLIERS

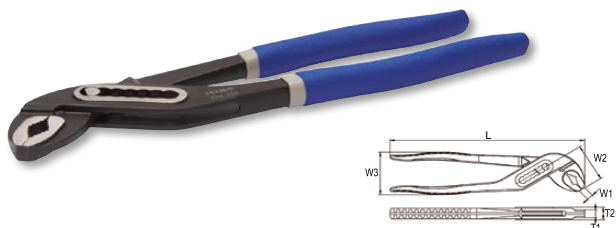

- High performance steel
- Hardness: teeth hardened to 50-57 HRc
- Standard: ISO 8976

Code	Material	L mm	W1 mm	W2 mm	W3 mm	T1 mm	T2 mm	g
634-200-1	5	175	5.8	35.8	41	7	12	170
634-250-1	5	240	5	47.5	50	7.5	12.5	320
634-300-1	5	302	3	52.5	59.6	8	14.5	430

QUICK ADJUST SLIP JOINT PLIERS



- With button for a quick adjustment
- High performance steel
- Hardness: teeth hardened to 50-57 HRc
- Standard: ISO 8976

Code	Material	L mm	W1 mm	W2 mm	W3 mm	T1 mm	T2 mm	g
634Q-250-1	5	240	5	47.5	50	7.5	12.5	320

PLIERS SETS

PLIERS SETS



- High performance steel
- Bi-material handles

Code	Material	Box	Dimensions	g
601-3-C	1	3	270 x 205 x 40	690

601-180-1	
624-160-1	
612-200-1	

PLIERS SETS



- High performance steel
- Bi-material handles

Code	Material	Box	Dimensions	g
602-3-C	1	3	270 x 205 x 40	850

601-180-1	
624-160-1	
634-250-1	



MINI PLIERS

MINI COMBINATION PLIERS

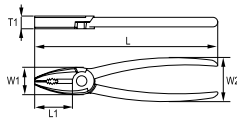

- Mini combination pliers for fine assembly work in electronics and fine mechanics
- With gripping zones for flat and round material, suitable for versatile use
- With cutting edge for soft wire
- Cutting edge hardness: 58-65 HRc
- Soft grip bimaterial handles provide comfort and control
- Equipped with a return spring
- High performance alloy steel
- Standard: ISO 9655
- Cutting capacity:
 - 1- Min. cutting capacity Cu: 0.5 mm
 - 2- Max. cutting capacity medium hard wire: 0.8 mm

601M-125-1	5	120	22	15	85	7	0.5	0.8	60
		L mm	L1 mm	W1 mm	W2 mm	T1 mm	1 mm	2 mm	g

MINI FLAT NOSE PLIERS

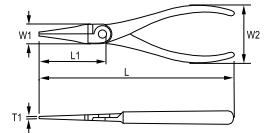

- Mini flat nose pliers for fine assembly work in electronics and fine mechanics
- Smooth jaws for gripping, holding and bending delicate components
- Hardness: 42-50 HRc
- Soft grip bimaterial handles provide comfort and control
- Equipped with a return spring
- High performance alloy steel
- Standard: ISO 9655

604M-125-1	5	130	27	12	85	8	89
		L mm	L1 mm	W1 mm	W2 mm	T1 mm	g

MINI SNIPE NOSE PLIERS

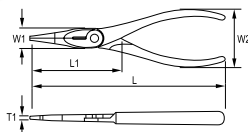

- Mini snipe nose pliers for fine assembly work in electronics and fine mechanics
- With serrated jaws for a better grip
- With cutting edge for soft wire
- Cutting edge hardness: 58-65 HRc
- Soft grip bimaterial handles provide comfort and control
- Equipped with a return spring
- High performance alloy steel
- Standard: ISO 9655
- Cutting capacity:
 - 1- Min. cutting capacity Cu: 0.5 mm
 - 2- Max. cutting capacity medium hard wire: 0.8 mm

612M-125-1	5	130	27	12	85	8	0.5	0.8	86
		L mm	L1 mm	W1 mm	W2 mm	T1 mm	1 mm	2 mm	g

MINI SIDE CUTTING PLIERS

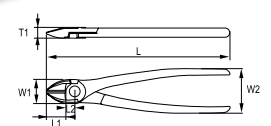

- Mini side cutting pliers for fine cutting work in electronics and fine mechanics
- With induction hardened cutting edge for soft and hard wire
- Oval head design
- Cutting edge hardness: 58-65 HRc
- Soft grip bimaterial handles provide comfort and control
- Equipped with a return spring
- High performance alloy steel
- Standard: ISO 9654
- Cutting capacity:
 - 1- Min. cutting capacity Cu: 0.5 mm
 - 2- Max. cutting capacity medium hard wire: 0.8 mm

624M-125-1	5	120	16	12	85	8	0.5	0.8	81
		L mm	L1 mm	W1 mm	W2 mm	T1 mm	1 mm	2 mm	g

MINI END CUTTING PLIERS

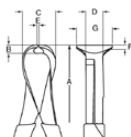

- Mini end cutting pliers for fine cutting work in electronics and fine mechanics
- With induction hardened cutting edge for soft and hard wire
- Cutting edge hardness: 58-65 HRc
- Soft grip bimaterial handles provide comfort and control
- Equipped with a return spring
- High performance alloy steel
- Standard: ISO 9654
- Cutting capacity:
 - 1- Min. cutting capacity Cu: 0.5 mm
 - 2- Max. cutting capacity medium hard wire: 0.8 mm

Q	A	B	C	D	E	F	G	1 mm	2 mm	g	
	mm	mm	mm	mm	mm	mm	mm				
626M-125-1	5	110	8	16	10	3	3	9	0.5	0.8	81

PLIERS FOR ELECTRICIANS

STRIPPING PLIERS

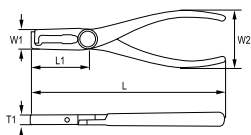

- High performance steel
- Hardness: 45-50 HRc

Q	L	L1	W1	W2	T1	+	g	
	mm	mm	mm	mm	mm	mm		
629-160-1	5	160	40.5	19	48	9	1-6	170

COPPER ALUMINIUM WIRE CUTTER

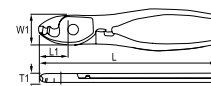

- Wire cutting and stripping pliers for copper and aluminium
- Finish: Forged surfaces are black finished and mirror polished
- Material: Carbon steel, PVC coated handles

Q	L	L1	W1	T1	+	g		
	mm	mm	mm	mm	mm			
655-160-1	5	160	25	25	10	50/35	10	160
655-200-1	5	200	28	30	12	70/50	13	280

PLIERS FOR ELECTRICIANS

CRIMPING PLIER INSULATED TERMINALS



- Pliers made of thick metal steel sheet and working areas are hardened
- Lightweight, occupy small volume and are easy to carry in the toolbox
- Suitable for crimping, cutting and stripping operations
- Crimping terminals: 1.5/2.5/6 mm²
- Cutting: M2.6-M5.0
- Stripping: 0.75-6.0 mm²

Code	Box	L (mm)	A (mm)	C (mm)	mm ²	AWG	mm ²	AWG	mm ²	g
630-B1-1	12	220	38	3	1.5-6.0	20-10	0.75-6.0	20-10	0.75-6.00	220

CRIMPING PLIER NON-INSULATED TERMINALS



- Pliers made of thick metal steel sheet and working areas are hardened
- Lightweight, occupy small volume and are easy to carry in the toolbox
- Suitable for crimping, cutting and stripping operations
- Crimping terminals: 1.5/2.5/6 mm²
- Cutting: M2.6-M5.0
- Stripping: 0.75-6.0 mm²

Code	Box	L (mm)	A (mm)	C (mm)	mm ²	AWG	mm ²	AWG	mm ²	g
630-B2-1	12	220	38	3	1.5-6.0	14-10	0.75-6.0	18-12	0.75-6.00	220

CRIMPING PLIER NON-INSULATED FASTON TYPE TERMINALS



- Pliers made of thick metal steel sheet and working areas are hardened
- Lightweight, occupy small volume and are easy to carry in the toolbox
- Suitable for crimping, cutting and stripping operations
- Crimping terminals: 1.5/2.5/6 mm²
- Cutting: M2.6-M5.0
- Stripping: 0.75-6.0 mm²

Code	Box	L (mm)	A (mm)	C (mm)	mm ²	AWG	mm ²	AWG	mm ²	g
630-B3-1	12	220	38	3	1.5-6.0	14-10	0.75-6.0	18-12	0.75-6.00	220

CRIMPING PLIER INSULATED TERMINALS SET



- Pliers made of thick metal steel sheet and working areas are hardened
- Lightweight, occupy small volume and are easy to carry in the toolbox
- Suitable for crimping, cutting and stripping operations
- 60 insulated terminals and crimping pliers are included in the set
- Crimping terminals: 1.5/2.5/6 mm²
- Cutting: M2.6-M5.0
- Stripping: 0.75-6.0 mm²

Code	Box	Quantity	Dimensions (mm)	Weight (g)
630-61B1-4	1	60 + 1	24 x 160 x 270	370

INSULATED PLIERS

INSULATED COMBINATION PLIERS

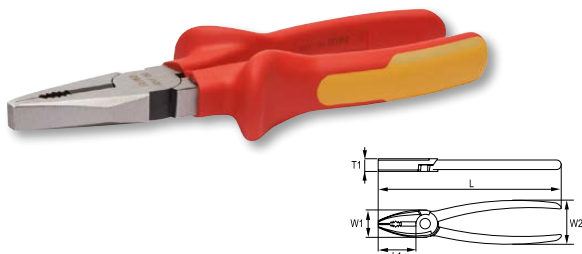

- For work on live equipment, up to 1000V
- High performance steel
- Hardness: edges at 58-65 HRc
- Standard: ISO 5746
- Cutting capacity:
 - 1- Bronze wire: 1.00 mm
 - 2- Medium hard wire: 1.60-2.00-2.50 mm

Q	Icon	L mm	L1 mm	W1 mm	W2 mm	T1 mm	1 mm	2 mm	g
601V-160-1	5	160	35	24	50	10	Ø 1.0 mm	Ø 1.6 mm	190
601V-180-1	5	180	38	27	50	10	Ø 1.0 mm	Ø 2.0 mm	240
601V-200-1	5	197	41.5	29.5	50	11	Ø 1.0 mm	Ø 2.5 mm	300

INSULATED FLAT NOSE PLIER

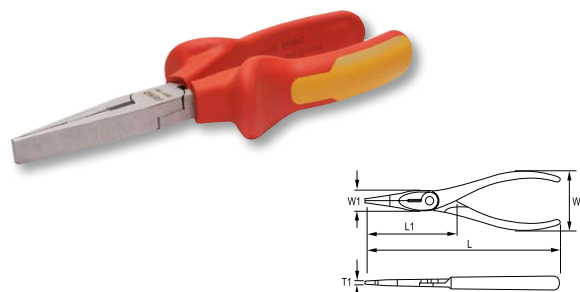

- For work on live equipment, up to 1000V
- High performance steel
- Hardness: edges at 58-65 HRc
- Standard: ISO 5745

Q	Icon	L mm	L1 mm	W1 mm	W2 mm	T1 mm	g
604V-160-1	5	158	48	17	50	9	150

INSULATED SNIPE NOSE PLIERS

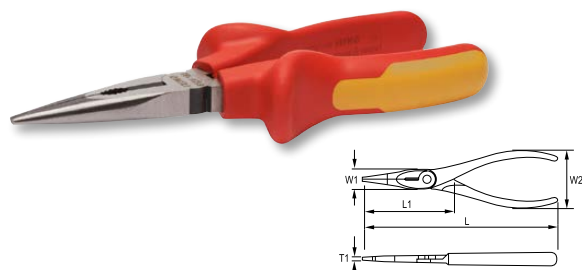

- High performance steel
- Hardness: edges at 58-65 HRc
- Standard: ISO 5746
- Cutting capacity:
 - 1- Bronze wire: 1.00 mm
 - 2- Medium hard wire: 1.60 mm

Q	Icon	L mm	L1 mm	W1 mm	W2 mm	T1 mm	1 mm	2 mm	g
612V-160-1	5	161	61.5	16.5	49	10	Ø 1.0 mm	Ø 1.6 mm	140
612V-200-1	5	201	78	18	50	10.5	Ø 1.0 mm	Ø 1.6 mm	180

INSULATED SNIPE NOSE PLIERS BENT TIP

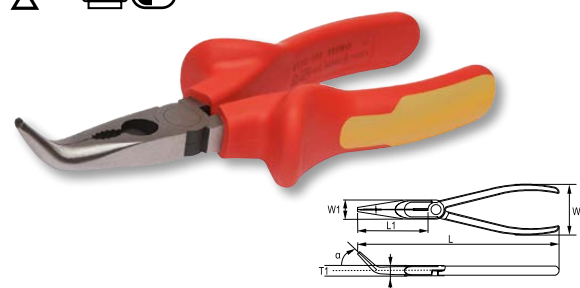

- For work on live equipment, up to 1000V
- High performance steel
- Hardness: edges at 58-65 HRc
- Angled at 45°
- Standard: ISO 5746
- Cutting capacity:
 - 1- Bronze wire: 1.00 mm
 - 2- Medium hard wire: 1.60 mm

Q	Icon	L mm	L1 mm	W1 mm	W2 mm	T1 mm	α	1 mm	2 mm	g
613V-160-1	5	158	50	18	18	9.0	45°	Ø 1.0 mm	Ø 1.6 mm	132
613V-200-1	5	197	74	18	50	10.5	45°	Ø 1.0 mm	Ø 1.6 mm	180



INSULATED PLIERS

INSULATED SIDE CUTTING PLIERS

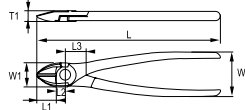

- For work on live equipment, up to 1000V
- High performance steel
- Hardness: edges at 60-65 HRC
- Standard: ISO 5749
- Cutting capacity:
 - 1- Bronze wire: 0.50 mm
 - 2- Medium hard wire: 1.60 mm

	Q	Box	L mm	L1 mm	L2 mm	L3 mm	W1 mm	W2 mm	T1 mm	1 mm	2 mm	g
624V-140-1	5		142	20.5	7	13	18.6	50	10.0	Ø 0.5 mm	Ø 1.6 mm	170
624V-160-1	5		155	21.5	7	13	21.6	50	11.5	Ø 0.5 mm	Ø 1.6 mm	200

INSULATED HEAVY DUTY SIDE CUTTING PLIERS

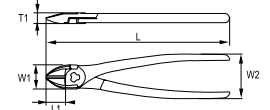

- For work on live equipment, up to 1000V
- High performance steel
- Hardness: edges at 60-65 HRC
- Standard: ISO 5749
- Cutting capacity:
 - 1- Bronze wire: 0.50 mm
 - 2- Medium hard wire: 1.80 mm

	Q	Box	L mm	L1 mm	W1 mm	W2 mm	T1 mm	1 mm	2 mm	g
625V-180-1	5		180	20.5	25.6	49	11.5	Ø 0.5 mm	Ø 1.8 mm	280

INSULATED STRIPPING PLIERS

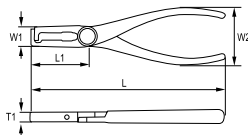

- For work on live equipment, up to 1000V
- High performance steel
- Hardness: 45-50 HRC

	Q	Box	L mm	L1 mm	W1 mm	W2 mm	T1 mm	1 mm	g
629V-160-1	5		160	40.5	19	48	9	1-6	170

INSULATED SLIP JOINT PLIERS

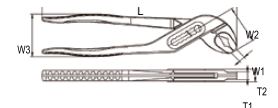

- For work on live equipment, up to 1000V
- High performance steel
- Hardness: teeth hardened to 50-57 HRC
- Standard: ISO 8976

	Q	Box	L mm	W1 mm	W2 mm	W3 mm	T1 mm	T2 mm	g
634V-250-1	5		240	5	47.5	50	7.5	12.5	310

INSULATED PLIERS SETS

INSULATED PLIERS SET



- For work on live equipment, up to 1000V
- High performance steel
- Standard: IEC 60900

	Q	Box	Box	g
601V-3-C	1	3	270 x 205 x 40	690
624V-160-1			601V-180-1	
612V-200-1				

BOLT CUTTERS

BOLT CUTTERS



- High performance alloy steel
- Double heat treatment on the blades
- Black finish

E	Icon	L	A	B	Ø	Ø	Ø	g	
		mm	mm	mm	80 kg/mm ²	160 kg/mm ²	120 kg/mm ²		
651101	1	N.0	320	48	77	5	4	3	500
651111	1	N.1	470	66	104	7	6	5	1.785
651121	1	N.2	630	85	137	9	8	7	2.860
651131	1	N.3	750	100	160	11	9	8	4.410
651141	1	N.4	900	120	182	13	10	9	5.800

SPARE HEAD BOLT CUTTER



E	Icon	Icon	A	B	g
			mm	mm	
651201N	1	651101	48	77	180
651211N	1	651111	66	104	370
651221N	1	651121	85	137	875
651231N	1	651131	100	160	1.295
651241N	1	651141	120	182	1.930

PINCERS AND FENCING PLIERS

CARPENTER'S PINCERS

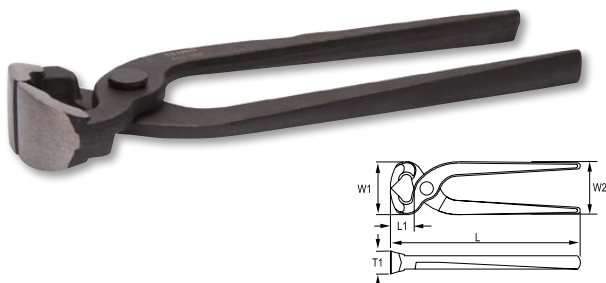

- Hardness: teeth hardened at 58-64 HRC
- Standard: ISO 5746
- Cutting capacity: Medium hard wire: 1.60 mm

E	Icon	L	L1	W1	W2	T1	Icon	g
		mm	mm	mm	mm	mm	2 mm	
631-200-1	5	200	23	53	45	24	1.6 mm	360

FENCING PLIERS

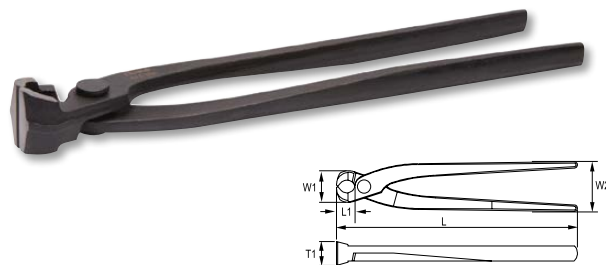

- Hardness: teeth hardened to 58-64 HRC
- Standard: ISO 9242
- Cutting capacity: Medium hard wire: 1.60 mm

E	Icon	L	L1	W1	W2	T1	Icon	g
		mm	mm	mm	mm	mm	2 mm	
632-220-1	5	220	16	29.4	46	22	1.6 mm	350
632-250-1	5	250	18	33	46	24.5	1.6 mm	400
632-280-1	5	280	19	37	48	24.5	1.6 mm	460

FENCING PLIERS WITH PVC DIPPED HANDLES

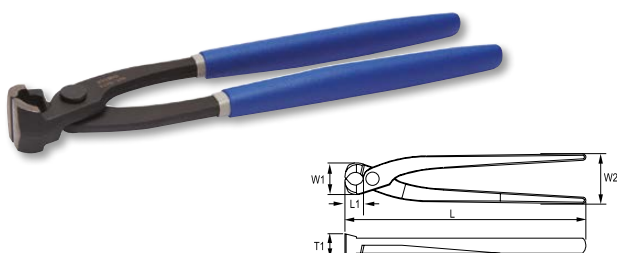

- High performance steel
- Blue dipped handles
- Hardness: teeth hardened to 58-64 HRC
- Standard: ISO 9242
- Cutting capacity 1.6 mm

E	Icon	L	L1	W1	W2	T1	Icon	g
		mm	mm	mm	mm	mm	2 mm	
632D-250-1	5	250	18	33	46	24.5	1.6 mm	400



CIRCLIP PLIERS

INTERNAL STRAIGHT



- Black finish for corrosion protection
- High performance alloy steel
- Straight forged tips
- Hardness: 45-50 HRC
- Standard: DIN 5256

R	Icon	L mm	B mm	E mm	Icon	Icon	g
621551	5	140	38	0.8	8 - 13	1	80
621561	5	140	38	1.2	12 - 25	1	80
621571	5	180	57	1.7	19 - 60	1	170
621581	5	225	69	2.2	40 - 100	1	275
621591	1	310	95	3.1	85 - 165	1	490

INTERNAL BENT TIP



- Black finish for corrosion protection
- High performance alloy steel
- Curved forged tips
- Hardness: 45-50 HRC
- Standard: DIN 5256

R	Icon	L mm	B mm	E mm	Icon	Icon	g
621651	5	127	25	0,8	8 - 13	1	80
621661	5	127	25	1,2	12 - 25	1	80
621671	5	165	43	1,7	19 - 60	1	170
621681	5	208	52	2,2	40 - 100	1	275
621691	1	289	74	3,1	85 - 165	1	490

EXTERNAL STRAIGHT



- Black finish for corrosion protection
- High performance alloy steel
- Straight forged tips
- Internal spring
- Hardness: 45-50 HRC
- Standard: DIN 5254

R	Icon	L mm	B mm	E mm	Icon	Icon	g
621751	5	140	38	0.8	3 - 10	1	80
621761	5	140	38	1.2	10 - 25	1	80
621771	5	180	57	1.7	19 - 60	1	170
621781	5	225	69	2.2	40 - 100	1	275
621791	1	295	95	3.1	85 - 165	1	490

EXTERNAL BENT



- Black finish for corrosion protection
- High performance alloy steel
- Bent forged tips
- Internal spring
- Hardness: 45-50 HRC
- Standard: DIN 5254

R	Icon	L mm	B mm	E mm	Icon	Icon	g
621851	5	127	25	0.8	3 - 10	1	80
621861	5	127	25	1.2	10 - 25	1	80
621871	5	165	43	1.7	19 - 60	1	170
621881	5	208	52	2.2	40 - 100	1	275
621891	1	295	74	3.1	85 - 165	1	490

CIRCLIP PLIERS SET



- Black finish for corrosion protection
- High performance alloy steel
- Forged tips
- Hardness: 45-50 HRC

R	Icon	Icon	Icon	g
601911	1	4	260 x 220 x 30	750
621571	Icon	Icon	621671	Icon
621771	Icon	Icon	621871	Icon

METAL SHEARS. AVIATION / COMPOUND SHEAR

STRAIGHT CUT



- Forged from steel containing chromium and molybdenum for good resistance
- Lever system increases efficiency
- Handles with soft grip part and return spring to enhance the working comfort
- Cutting capacity: 1-Stainless steel, 2-Cold rolled steel

Q	Icon	L mm	1 mm	2 mm	g
658-250-1	1	250	0.7	1.2	390

RIGHT CUT



- Forged from steel containing chromium and molybdenum for good resistance
- Lever system increases efficiency
- Handles with soft grip part and return spring to enhance the working comfort
- Cutting capacity: 1-Stainless steel, 2-Cold rolled steel

Q	Icon	L mm	1 mm	2 mm	g
659-250-1	1	250	0.7	1.2	395

LEFT CUT



- Forged from steel containing chromium and molybdenum for good resistance
- Lever system increases efficiency
- Handles with soft grip part and return spring to enhance the working comfort
- Cutting capacity: 1-Stainless steel, 2-Cold rolled steel

Q	Icon	L mm	1 mm	2 mm	g
660-250-1	1	250	0.7	1.2	405

LOCKING PLIERS

UNIVERSAL, CURVED JAWS WITH WIRE CUTTER



- General purpose, holds bars and sheets, nuts and bolts
- Strong jaws, drop forged
- Chrome molybdenum steel
- Nickel plated

Q	Icon	A mm	B mm	C mm	D mm	E mm	F mm	G mm	Fe+ mm	g	
64A-190-1		190	31	40	12	0-20	7	5	2	338	358
64A-235-1		225	38	48	12	0-35	7	6	3	543	556

UNIVERSAL, STRAIGHT JAWS



- Holds metal sheet, small bars and thin pieces
- Strong jaws, reinforced. Drop forged
- Chrome molybdenum steel
- Nickel plated

Q	Icon	A mm	B mm	C mm	D mm	E mm	F mm	g
64B-190-1	1	190	29	42	15	0-17	13	358
64B-235-1	1	225	32	54	17	0-21	13	556



LOCKING PLIERS

LONG NOSE



- Long reach jaws. Drop forged
- Jaws have flat and round holding shapes
- Chrome molybdenum steel
- Nickel plated

Part No.	QTY	A mm	B mm	C mm	D mm	E mm	F mm	g
64L-165-1	1	165	52	25	9	6	0-18	195

WELDING



- U shape jaws provides accessibility and good vision in welding jobs
- Jaws beam-shaped to increase strenght
- Chrome molybdenum steel
- Nickel plated

Part No.	QTY	A mm	B mm	C mm	D mm	E mm	F mm	g
64W-300-1	1	263	75	70	75	70	44	832

STEEL CLAMP



- C shape to hold bulky parts
- Chrome vanadium steel
- Nickel plated

Part No.	QTY	A mm	B mm	C mm	D mm	E mm	F mm	g
64C-300-1	1	275	90	140	14	0-65	7	775

STEEL CLAMP, SWIVEL PADS



- C shape to hold bulky parts
- Swivel pads to hold non parallel and uneven parts
- Chrome vanadium steel
- Nickel plated

Part No.	QTY	A mm	B mm	C mm	D mm	E mm	F mm	g
64CA-175-1	1	175	61	90	21	0-32	5	276
64CA-300-1	1	280	95	130	28	0-72	7	835
64CA-450-1	1	460	270	150	28	0-130	7	1280

STEEL CLAMP, SWIVEL PADS, SLIM



- Long reach
- Swivel pads to hold non parallel and uneven parts
- Chrome molybdenum steel
- Nickel plated

Part No.	QTY	A mm	B mm	C mm	D mm	E mm	F mm	g
64CAD-300-1	1	282	97	81	28	0-72	7	850

TABLE C CLAMP

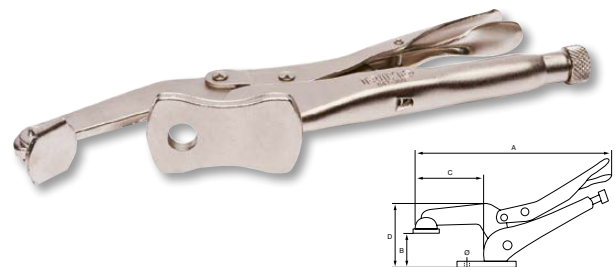

- Swivel pad to hold non parallel and uneven parts
- Hidden lever to avoid unwanted unlocking
- Chrome molybdenum steel
- Nickel plated

Part No.	QTY	A mm	B mm	C mm	D mm	Ø mm	g
64T-300-1	1	300	0-80	95	90	12.4	650

4 POSITION PLIERS



- Chrome-plated for good rust protection
- Shape: with flat and convex jaws that can be adjusted in 4 different positions for an increased gripping capacity
- Application: holds most L, T and U profiles
- Retail packed

E	Icon	A mm	B mm	C mm	D mm	E mm	F mm	g
647-235-1	1	235	37	59	17	10	15	540

4 POSITION PLIERS



- Chrome-plated for good rust protection
- Shape: with flat and convex jaws that can be adjusted in 4 different positions for an increased gripping capacity
- Extra long jaws with twice as large gripping capacity compared to standard model
- Application: holds most L, T and U profiles
- Retail packed

E	Icon	A mm	B mm	C mm	D mm	E mm	F mm	g
647-250-1	1	255	67	64	17	10	15	650

CURVED JAWS WITH CUTTER



- Shape: curved jaws for general purpose
- Soft grip two-component handle

E	Icon	L mm	C mm	g
648-140-1	1	140	7	28
648-185-1	1	185	8.5	41
648-250-1	1	225	10.5	48

LONG NOSE



- Shape: long slim jaw design
- Soft grip two-component handle

E	Icon	L mm	C mm	g
648-165-1	1	165	4.2	57

SOFT GRIP PLIERS SET



- Two-component handle
- Rolling nylon pouch

E	Icon	X	g
648-4-W	1	4	1.200

648-140-1, 648-185-1, 648-250-1	
648-165-1	

AUTOMATIC HAND VICES



- Finish: black
- Shape: locking clamp with movable jaw for increased flexibility and general purpose work
- Application: for production or maintenance applications and general purpose work

E	Icon	A mm	B mm	C mm	Icon	Icon	Icon	g
645011	1	193	30	32	645-L075	645-YOKE	645-NUT	690
645021	1	196	30	70	645-L120	645-YOKE	645-NUT	765
645031	1	240	62	70	645-L120	645-YOKE	645-NUT	935
645041	1	240	62	150	645-L200	645-YOKE	645-NUT	1.180



RIVETING TOOLS

HAND RIVETER



- Riveter with four different exchangeable heads for rivet sizes of 1.8-2.2-2.8-3.2 mm
- To be used with aluminium, steel, stainless steel and copper rivets
- Includes a wrench for changing heads

R	Icon	L mm	A mm	B mm	g
546-265-1	1	265	90	25	700



Spare parts for hand riveter 546-265-1			Icon
546-265-A	Jaw mechanism	1	
546-265-B	Mouthpieces set	1	

2 ARM RIVETER



- Riveter with long handles for greater leverage
- To be used with aluminium, steel and stainless rivets
- The transparent tube collects snapped off rivet tails

R	Icon	A mm	B mm	C mm	D mm	g
546021	1	520	22	58	160	1.800



Spare parts 546021	
546201	Nosepiece of Ø 4 mm
546211	Nosepiece of Ø 5 mm
546221	Nosepiece of Ø 6-6.4 mm
546251	3 jaws set
1467-A01	Transparent tube

NUT RIVETER SET



- To create a threaded fixing where there is little or no access to the rear of a panel
- Supplied with the inserts for the different rivet nut sizes as well as the necessary tools to assemble and disassemble those inserts
- To be used with aluminium, steel and stainless steel nuts of M3-M4-M5-M6

R	Icon	L mm	A mm	B mm	g
548-275-1	1	270	100	23	700



Spare parts for hand riveter 548-275-1			Icon
548-275-M3	M3 insert	1	
548-275-M4	M4 insert	1	
548-275-M5	M5 insert	1	
548-275-M6	M6 insert	1	

HAND RIVETER SET WITH RIVETS



- 265 mm riveter with four different exchangeable heads for rivet sizes of 2.4 mm; 3.0-3.2 mm; 4.0 mm and 4.8 mm
- Includes a wrench for changing heads
- To be used with aluminum, steel, stainless steel and copper rivets
- 160 rivets (40 of each size)
- Blow molded case

R	Icon	L mm	Dimensions	g
546-265-4	1	160	300 x 210 x 60	1.200

UTILITY KNIFE

9 MM SNAP OFF KNIFE

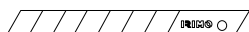

85x9x0.50 mm

667-135-1	12	133	56

18 MM SNAP OFF KNIFE

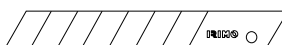

112x18x0.50 mm

666-156-1	12	157	106

SAFETY UTILITY KNIFE



60x19x0.635 mm



- Autoretractil blade for safety purposes

668-150-1	12	150	157

SAFETY UTILITY KNIFE



60x19x0.635 mm



- Auto retractil blade when cutting is finished and operation button is released
- Easy Open System (EOS)

669-175-1	10	175	210

QUICK CHANGE CUTTER



60x19x0.635 mm



- Blade safety system
- Quick blade changing system
- 6 Blade stock
- Supplied with 6 blades
- Rubber handle
- Injected metal body
- For high accuracy knives of 0.6 mm

Z150003	1	200	250

GLASS SCRAPER WITH INTERCHANGEABLE BLADES

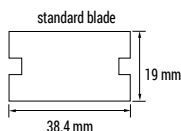

standard blade

19 mm

38.4 mm



- Ideal for removing paint, glue, putty or stickers from glass, tile, walls, floors and other smooth surfaces
- Ergonomic two-component design for comfortable no-slip grip
- Blade retracts for safe storage
- Internal storage compartment (includes 5 blades)
- Good size to fit in the palm of your hand. Scraper length 130 mm
- Uses standard sing-edge razor blades. Blade width: 40 mm

538-140-1	1	135	65

MULTIPURPOSE TRADESMAN KNIVES WITH SHEATH

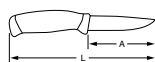

- Comfortable handle provides excellent grip
- Supplied with a practical sheath for belt carrying
- Robust multipurpose knife with a solid stainless steel blade

672-220-1	12	100	220	233



ELECTRICIAN'S SCISSORS AND KNIVES

FOLDABLE KNIFE



- 3Cr13 Stainless Steel
- Retail pack
- Light and comfortable
- Belt clip included
- Strong cutting tool
- Blade thickness 2.3 mm

Code	Pack	A mm	L mm	g
670-178-1	10	78	178	120

FOLDABLE KNIFE



- Black 3Cr13 Stainless Steel
- Retail packaging
- Black finishing
- Comfortable and strong cutting tool
- Belt clip included
- Blade thickness 2.6 mm

Code	Pack	A mm	L mm	g
669-190-1	10	77	190	130

ELECTRICIANS' KNIFE



- Electrician's pocket folding knife
- Wire stripping shape with wooden handle

Code	Pack	A mm	L mm	g
664-200-1	10	85	200	83

ELECTRICIANS' KNIFE



- Electrician's pocket folding knife
- Stainless steel blade with plastic handle
- Wire stripping shape

Code	Pack	A mm	L mm	g
665-200-1	10	85	200	60

MULTITOOL



- Foldable Knife
- 3Cr13 Stainless Steel
- Comes with clip
- Length: 96 mm closed / 150 mm overall
- Pouch included for easy transport
- Multi tool for all purposes with:
 - Needle Nose Pliers
 - Wire cutter
 - Slotted Screwdriver
 - Medium Slotted Screwdriver
 - Wood / Metal File
 - Bottle opener
 - Phillips Screwdriver
 - Regular Pliers
 - Can Opener
 - Small Slotted Screwdriver
 - Saw
 - Large slotted screwdriver
 - Slotted Screwdriver
 - Scissors

Code	Pack	L mm	g
671-150-1	10	150 (96)	255

ELECTRICIANS' SCISSORS



- Electrician's scissors with plastic coated finger loops
- Small groove in the blade for stripping cables
- 43 mm Cutting length

R	Icon	A mm	L mm	g
661051	10	42.5	130	70

ELECTRICIANS' SCISSORS



- Electrician's scissors with longer handles, plastic coated finger loops
- Small groove in the blade for stripping cables
- Better access to confined spaces
- Requiring less cutting force
- 38 mm cutting length

R	Icon	A mm	L mm	g
661061	10	38	152	130

ELECTRICIANS' SCISSORS



- Electrician's scissors with plastic coated finger rings
- Professional use. Integrate steel structure
- Micro serrated blade
- 43 mm cutting length
- Rotary belt holster

R	Icon	A mm	L mm	g
661-140-1	12	43	145	76



- Display for 12 scissors

R	Icon	g
661-140-12-DISP	1	

HOOKS AND PICKING TOOLS

MINI PICK AND HOOK SET, 4 pieces

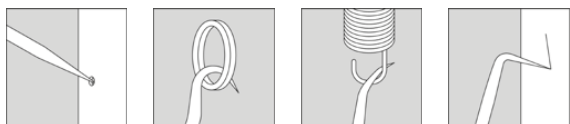

- Used for scratching, manipulating or removing O-rings, springs, welding,...
- 170 mm length
- Two-component Soft grip handle
- Material: Carbon steel blades, hardened tips
 - 1 pc straight pick,
 - 1 pc angle hook,
 - 1 pc full hook,
 - 1 pc 90° hook

R	Icon	Icon	Icon	g
722-4-1	12	4	20 x 230 x 130	100





10. PULLING TOOLS

PULLERS

UNIVERSAL 2 ARM PULLERS

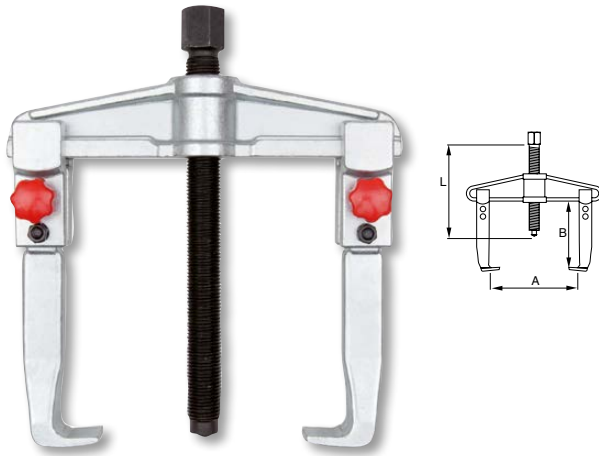

- Body and arms manufactured from forged steel
- Beam shape section light and strong
- Finish: galvanised, with induction hardened spindle
- By reversing the arms, the extractor can be used as internal or external
- Protective case on screw top for easy use
- Quick-adjust screws for an easy and quick fitting

Part No.	Code	Qty	A mm	B mm	L mm	Spindle	Weight g
701-90-1	N1	1	90	100	130	4	900
701-130-1	N11	1	130	100	130	4	980
701-160-1	N2	1	160	150	210	6	2.450
701-200-1	N21	1	200	150	210	6	2.880
701-250-1	N3	1	250	205	280	8	6.950
701-350-1	N31	1	350	205	280	8	7.680



Part No.	Code	Spindle	Length mm	Weight g	Part No.	Length mm	Weight g	Part No.	Length mm	Weight g
701-90-1	701-90-S	17	M14x1.5x130	175	701-90-K	95	528	701-90-B	136	315
701-130-1	701-90-S	17	M14x1.5x130	175	701-90-K	95	528	701-130-B	177	485
701-160-1	701-160-S	22	M20x2x210	575	701-160-K	150	1.058	701-160-B	217.5	890
701-200-1	701-160-S	22	M20x2x210	575	701-160-K	150	1.058	701-200-B	262	1.360
701-250-1	701-250-S	27	M27x2x280	1.275	701-250-K	202	3.262	701-250-B	330	2.750
701-350-1	701-250-S	27	M27x2x280	1.275	701-250-K	202	3.262	701-350-B	430	3.575

SELF-CENTERING 2 ARMS PULLERS

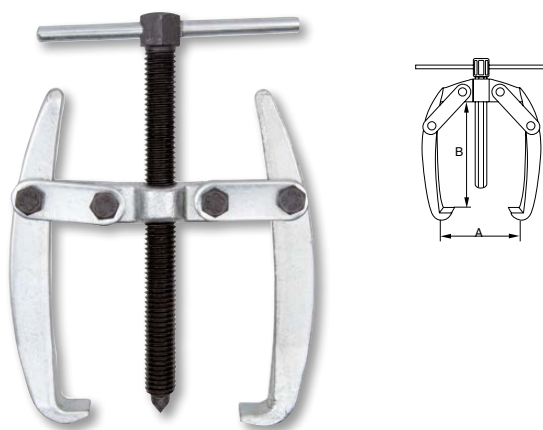

- Body and arms manufactured from forged steel
- Finish: galvanised, with induction hardened spindle
- Ideal for removing small parts such as battery terminals, pulleys, wheels, ball bearings, etc.
- Automatic gripping

Part No.	Qty	A mm	B mm	Spindle	Weight g
702-40-1	1	60	40	0.50	180
702-65-1	1	65	65	0.50	190
702-80-1	1	80	80	1.00	220



Part No.	Code	Spindle	Length mm	Weight g	Part No.	Length mm	Weight g	Part No.	Length mm	Weight g
702-40-1	702-40-S	M10x1.5x100	61	61	702-40-K	54.5	40		20	20
702-65-1	702-65-S	M10x1.5x105	63	63	702-65-K	88	74	702-40-B	42x13	20
702-80-1	702-80-S	M10x1.5x122	72	72	702-80-K	103	98	702-40-P	33.5x3	20

SELF-CENTERING 3 ARMS PULLERS

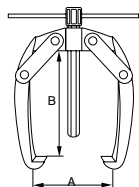

- Body and arms manufactured from forged steel
- Finish: galvanised, with induction hardened spindle
- Ideal for removing small parts such as battery terminals, pulleys, wheels, ball bearings, etc.
- Automatic gripping

Q	Box	A mm	B mm	mm T _h	g
703-40-1	1	60	40	0.75	230
703-65-1	1	65	65	0.75	290
703-80-1	1	80	80	1.50	320



Q	Q	mm	g	Q	L mm	g	Q	L mm	g	Q	L mm	g
703-40-1	702-40-S	M10x1.5x100	61	702-40-K	54.5	40			20			20
703-65-1	702-65-S	M10x1.5x105	63	702-65-K	88	74	703-40-B	42x13	20	702-40-P	33.5x3	20
703-80-1	702-80-S	M10x1.5x122	72	702-80-K	103	98			20			20

MULTIPLE PULLERS

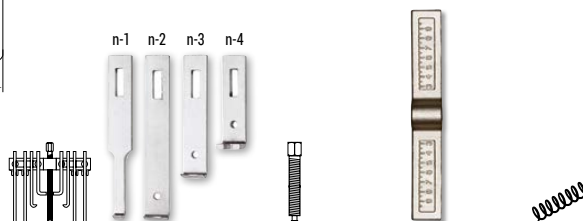
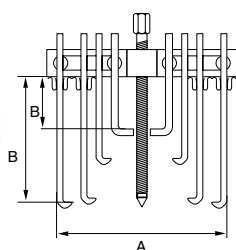
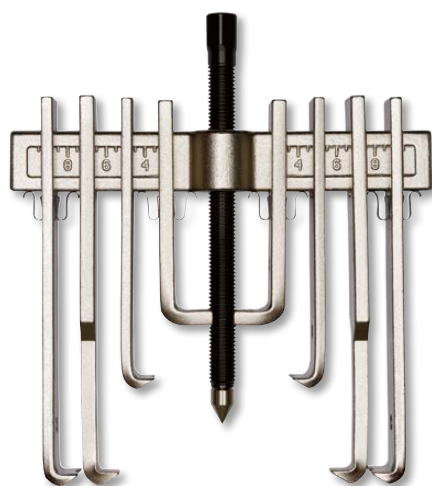

- Can be used as internal and external puller
- Two or more legs can be attached in line, obtaining greater reach

Q	Box	A (mm) min. - max.	B (mm) min. - max.	mm T _h	g
713001	1	20 - 173	65 - 140	5	2.700
713011	1	75 - 250	77 - 182	10	6.000

Q	Q	Q	Q	Q
713001	796511 n-1	796491	796501	796551
	796521 n-2			
	796531 n-3			
	796541 n-4			
713011	713511 n-1	713611	796561	796571
	713521 n-2			
	713531 n-3			
	713541 n-4			



EXTRACTORS

STUD EXTRACTORS BIT SET



- Stud extractor bit set, 15 pcs
- Finish: blasted
- Material: Ni-Cr-Mo
- Supplied in a compact plastic case

R		📦	📏	📦	📏	📦
ZH1100	1		200 x 105 x 35		1.000	
1/2"	ZH1101	3	5/8"	ZH1108	1/8"	
	ZH1102	4		ZH1109	3/16"	
	ZH1103	5		ZH1115	1/2"	
	ZH1104	5.5		ZH1110	1/4"	
	ZH1105	6		ZH1111	3/8"	
	ZH1106	8		ZH1112	11 mm	
	ZH1107	10		ZH1113	12 mm	
				ZH1114	14 mm	

STUD EXTRACTORS SETS



- To remove broken screws, studs and pipes
- Finish: chromed
- Material: High-quality carbon steel

R		📦	📏	📦	📏	📦	📏	📦
716-5-1	1	90 x 58 x 15	5	# 1, 2, 3, 4, 5	M3-M18	120		
716-8-1	1	215 x 130 x 50	8	# 1, 2, 3, 4, 5, 6, 7, 8	M3-M45	840		
	#	📏	📏	📏	📏	📦	📏	📦
716-M6-1	1	2.0	4.00	50	M 3-6	4		
716-M8-1	2	2.8	4.30	58	M 6-8	6		
716-M11-1	3	4.0	6.00	65	M 8-11	13		
716-M14-1	4	6.3	7.50	75	M 11-14	20		
716-M18-1	5	7.5	10.70	80	M 14-18	45		
	6	10.3	15.00	85	M 19-24	95		
	7	13.5	19.00	92	M 24-30	140		
	8	20.6	24.00	97	M 30-45	240		

TAP WRENCH



- With reversible ratchet: forward - reverse - locked
- Parallel clamping action
- Hardened jaws
- Sliding handle
- Chrome-plated steel

R		📦	📏	📏	📦
718211	1		2.6 - 5.5	85	180
718231	1		4.6 - 8	110	300

NUT SPLITTERS



- For splitting jammed or stripped nuts without damaging the stud thread
- Galvanised and gunmetal finish
- Material: special steel
- Suitable for nuts up to quality grade 6

R		📦	📏	📏	📏	📏	📏	📏	📏	📏
730011	1		32	126	M3-M16	6-27	440	796661	796671	
730131	1		42	170	M14-M24	24-40	560	796681	796691	

PICK-UP TOOLS

MAGNETIC PICK-UP TOOLS

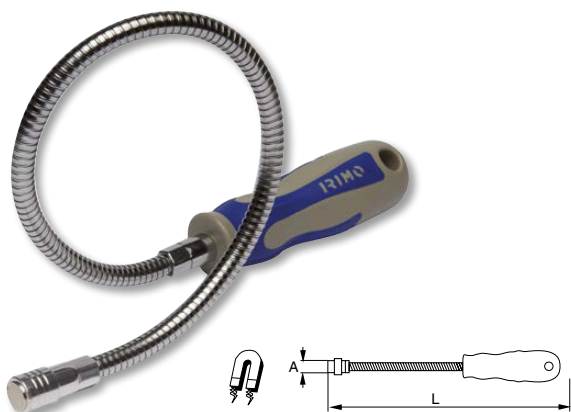

- Two component handle, with hanging hole and anti-roll design
- Polished and chrome-plated
- Blade finish: chrome-plated and polished
- 720-1M-413 has neodymium magnet with capacity of 1 kg and 720-3M-413 as neodymium magnet with capacity of 3 kg

Q	Icon	Ø mm	A mm	L mm	Icon	Icon	g
720-1M-413	1	10	10	550	413	110	130
720-3M-413	1	17	13	550	413	110	280

CLAW PICK-UP TOOL



- For gripping small parts
- Flexible shaft with steel core
- Finish: chrome-plated

Q	Icon	mm	g
720031	1	650	80

CLAW PICK-UP TOOL

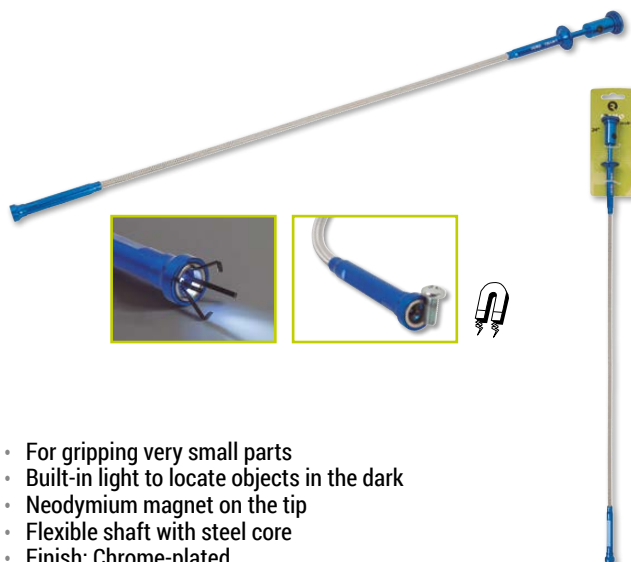

- For gripping very small parts
- Built-in light to locate objects in the dark
- Neodymium magnet on the tip
- Flexible shaft with steel core
- Finish: Chrome-plated

Q	Icon	mm	g
720-LM-1	1	625	120

PRY BARS

PRY BAR

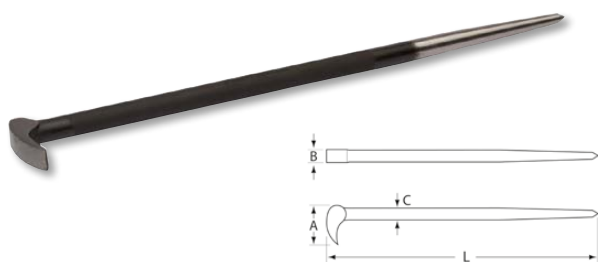

- 90° special lever. Suitable for work in confined spaces such as behind gears
- Finish: black phosphated with polished head and pointed tip
- Material: hardened special alloy steel

Q	Icon	A mm	B mm	C mm	L mm	g
066-400-1	1	44	14	14	406	450



PRY BARS

OFFSET LEVER SET



- Pry bars for easy prying and bending
- Plastic handles with lightweight design offers a comfortable grip as well as powerful leverage capacity

R	Box	Dimensions	Weight (g)
ZH70610	1	645 x 115 x 35	1.400
ZH70611, ZH70612, ZH70613, ZH70614			

OFFSET LEVER



- Pry bars for easy prying and bending
- Plastic handles with lightweight design offers a comfortable grip as well as powerful leverage capacity

R	Box	Length (mm)	Weight (g)
ZH70611	1	210	200
ZH70612	1	310	300
ZH70613	1	460	400
ZH70614	1	610	500

SHEET PUNCHES

SHEET METAL PUNCHES



- Screw hole punches
- For a 16 to 50 mm hole diameter
- Ground cutting areas for an easier cut
- Hexagonal head bolt
- For steel sheet plates up to 2 mm thick
- For stainless steel sheet plates up to 1.2 mm thick
- Individual packaging

R	Box	Ø mm	Thread	Weight (g)
740-016-2	1	16	M 8	80
740-020-2	1	20	M 10	120
740-022-2	1	22	M 10	160
740-025-2	1	25	M 10	180
740-030-2	1	30	M 12	320
740-035-2	1	35	M 12	500
740-040-2	1	40	M 14	660
740-050-2	1	50	M 14	1.040

SPARE BOLT



- Spare bolts for sheet metal punches 740 Series
- M8 to M14 Standard bolt
- Sold in a kit

R	Box	Ø mm
740S-008-2	6	M 8
740S-010-2	6	M 10
740S-012-2	6	M 12
740S-014-2	6	M 14



11. CUTTING TOOLS & MEASURING

BOWSAW FRAMES AND BLADES

BOWSAW FRAMES



- Powder painted steel tube bowsaw
- 802-2400-1 for dry wood (52)
- 802-3000-1 & 802-3600-1 for wet wood (23)
- Tooth protector included

Q	Box	mm	in	g	oz	
802-2400-1	5	607	24"	51	675	23.8
802-3000-1	5	759	30"	23	800	28.2
802-3600-1	5	912	36"	23	920	32.4

BOWSAW BLADES, GREEN WOOD



- Suitable for sawing in green wood - wet wood
- Hardened and tempered high-quality steel
- Rust prevention treated and packed in individual sleeve

Q	Box	mm	in	g	oz
802-2423-1	10	607	24"	60	2.1
802-3023-1	10	759	30"	75	2.6
802-3623-1	10	912	36"	95	3.4

BOWSAW BLADES, DRY WOOD



- For cutting dry, seasoned wood
- Hardened and tempered high-quality steel
- Rust prevention treated and packed in individual sleeve

Q	Box	mm	in	g	oz
802-2451-1	10	607	24"	65	2.3
802-3051-1	10	759	30"	80	2.8
802-3651-1	10	912	36"	100	3.5

HANDSAW & HACKSAWS

UNIVERSAL HANDSAWS



- Screwed 2-component handle
- Handle can be used for 45° and 90° marking guide
- Hard point handsaw for all types of wood

Q	Box	mm	in	g
800-168-1	10	400	16"	320
800-208-1	10	500	20"	360
800-228-1	10	550	22"	380

TENON SAW



- Tenon saw for fine and medium thick materials, specially adapted for cutting of small-diameter timber and mitre guide sawing
- Hardpoint universal teeth for long lasting sharpness
- Heavy steel back for rigidity and accurate cutting
- Screwed plastic handle

Q	Box	mm	in	g
800-131-1	10	300	12"	450

GENERAL PURPOSE HANDSAW



- General purpose saw with fine teeth for smooth sawing in a wide variety of materials, including aluminium, plastics, laminates, wood and chipboard
- Hardpoint fleam-toothing
- Toolbox size
- Screwed 1-piece plastic handle
- Ideal to carry in a toolbox

800-151-1	4	300	12"	15/16	225

DOVETAIL FLEX HANDSAW



- Saw blade for cutting wood & plastic materials
- Universal toothing, hardpoint teeth for long lasting sharpness
- Light steel back for rigidity
- Angled wooden handle to allow flush cutting
- Handle swings to allow both left and right hand sawing where access is restricted

800-111-1	4	250	10"	15/16	240

COMPASS SAW



- Compass saw for all kinds of wood and plastic material
- Hardpoint universal teeth for long lasting sharpness
- Screwed, plastic handle

800-141-1	4	300	12"	7/8	120

ALUMINIUM HACKSAW FRAME

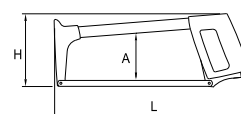
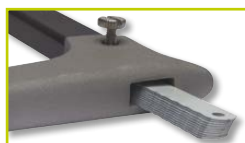

- Supplied with 300 mm (12") reliable and shatterproof bi-metal blade 24 TPI
- A professional and strong hacksaw frame
- Alternative 55° blade mounting for flush cutting

801101	5	400 (300)	24	748	

HACKSAW FRAME

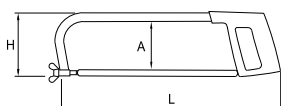

- Traditional design
- Easy to use hacksaw frame

		A mm	H mm	L mm	
801-041-1	10	110	151	400	665

BI-METAL



- Shatterproof bi-metal blade with precision teeth for all kinds of metal sawing
- Bi-metal blade is guaranteed to keep its sharpness for a long time
- Packaging:
 - 50 are 50 blades in a plastic box and
 - 5 are 5 blades in a special package with hanging loop

		LxWxT mm		
803-318-5	5	300 x 13 x 0.65	18	17
803-324-5	5	300 x 13 x 0.65	24	17
803-332-5	5	300 x 13 x 0.65	32	17
803-318-50	50	300 x 13 x 0.65	18	17
803-324-50	50	300 x 13 x 0.65	24	17
803-332-50	50	300 x 13 x 0.65	32	17



HANDSAW & HACKSAWS

ALUMINIUM HOLDER



- A useful mini-hacksaw for small spaces

Code	Qty	H mm	L mm	g
801-145-1	5	51	229	140

HACKSAW FRAME

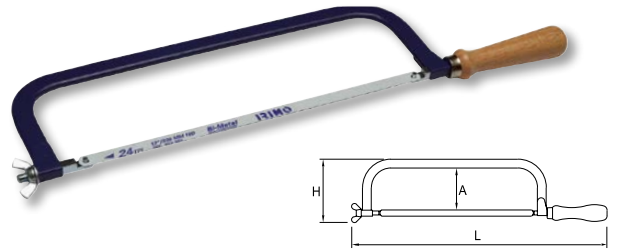

- A traditional designed, easy to use hacksaw frame

Code	Qty	A mm	H mm	L mm	g
801-011-1	10	100	128	512	575

HOLESAWS

HOLESAW SET, 9 pieces



- Bi-metal hole saw set of 9 pieces:
 - 6 pcs hole saws sizes 22, 29, 35, 44, 51 and 64 mm
 - 1 pc holder for big size hole saws (inc. Pilot drill)
 - 1 pc holder for small size hole saws (inc. Pilot drill)
 - 1 pc extra replacement Pilot drill

Code	Qty	Dimensions	g
810-2264-4	1	230 x 180 x 70	1.000

FILES

FLAT FILES

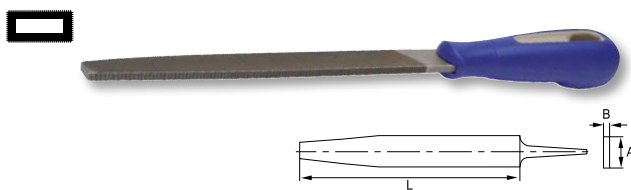

- Edges tapered towards the point, surface parallel
- Surface double cut, edges single cut

Code	Qty	L mm	A mm	B mm	Surface	Edges	g
BASTARD							
534521	6	150 / 6"	16	4	13	33	90
534531	6	200 / 8"	20	5	10	25	160
534541	6	250 / 10"	25	5.5	9	23	250
534551	6	300 / 12"	30	6	8	20	413
SECOND CUT							
534251	6	150 / 6"	16	4	18	46	50
534261	6	200 / 8"	20	5	14	36	160

HAND FILES

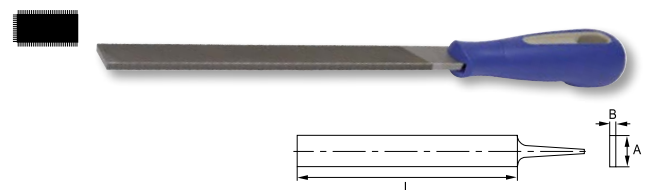

- Edges and surfaces parallel
- Surface double cut, one edge uncut and one edge single cut

Code	Qty	L mm	A mm	B mm	Surface	Edges	g
BASTARD							
534561	6	150 / 6"	16	4	13	33	90
534571	6	200 / 8"	20	5	10	25	160
SECOND CUT							
534281	6	150 / 6"	16	4	18	46	50
534291	6	200 / 8"	20	5	14	36	160

HALF ROUND FILES

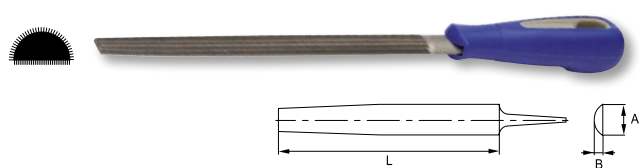

- Edges and surfaces tapered towards the point
- Double cut

Q	Icon	L mm	A mm	B mm	Icon	Icon	g
BASTARD							
534681	6	150 / 6"	16	4.7	13	33	100
534691	6	200 / 8"	20.5	6	10	25	170
534701	6	250 / 10"	26.5	7.5	9	23	344
SECOND CUT							
534371	6	150 / 6"	16	4.7	18	46	100
534381	6	200 / 8"	20.5	6	14	36	170

ROUND FILES

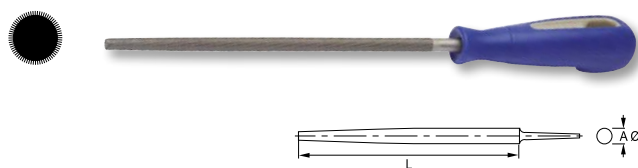

- Tapered towards the point
- Double cut

Q	Icon	L mm	A mm	B mm	Icon	Icon	g
BASTARD							
534601	6	150 / 6"	16	4.7	13	33	100
534611	6	200 / 8"	20.5	6	10	25	170
534621	6	250 / 10"	26.5	7.5	9	23	344
SECOND CUT							
534311	6	150 / 6"	16	4.7	18	46	100
534321	6	200 / 8"	20.5	6	14	36	170

THREE SQUARE FILES

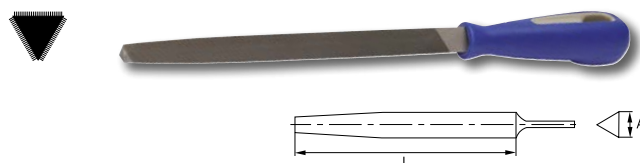

- Equilateral triangle, tapered towards the point
- Double cut surface

Q	Icon	L mm	A mm	Icon	Icon	g
BASTARD						
534901	6	150 / 6"	11	13	33	94
534911	6	200 / 8"	15.5	10	25	203
SECOND CUT						
534341	6	150 / 6"	11	18	46	94
534351	6	200 / 8"	15.5	14	36	203

SQUARE FILES

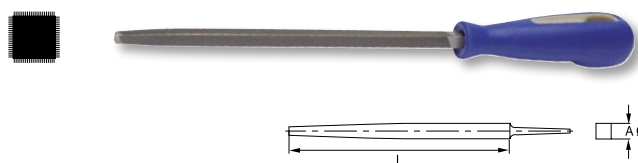

- Surface tapered towards the point
- Double cut surface

Q	Icon	L mm	A mm	Icon	Icon	g
BASTARD						
534931	6	150 / 6"	6	13	33	79
534941	6	200 / 8"	8	10	25	132
SECOND CUT						
534401	6	150 / 6"	6	18	46	79
534411	6	200 / 8"	8	14	36	132

FILE SET



Q	Icon	Icon	Icon	g
534501	1	6	44 x 37 x 3	1.150
534261	Icon	Icon	534351	Icon
534291	Icon	Icon	534381	Icon
534321	Icon	Icon	534411	Icon



SPIRIT LEVELS



* without handles: 982-40-1
982-4M-1



* with handles: 982-60-1
982-80-1
982-6M-1

- Accuracy ± 1 mm
- High visibility, barrel shape acrylic vials
- Three vials: horizontal, vertical and 45°
- Light aluminium material 1.5 kg/m
- Strong profile design. milled top and bottom measuring surfaces
- Long lasting epoxy painting

R	Icon	A mm	B mm	L mm	g
982-40-1	1	24	60	400	300
982-60-1	1	24	60	600	360
982-80-1	1	24	60	800	550

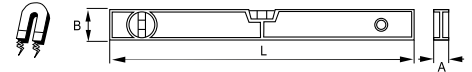

- Two magnets
- Separating force 9 Newton
- Three vials: horizontal, vertical and 45°

R	Icon	A mm	B mm	L mm	g
982-4M-1	1	22	60	400	280
982-6M-1	1	24	60	600	370

SPIRIT LEVELS

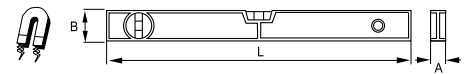
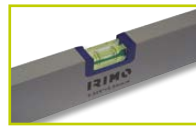
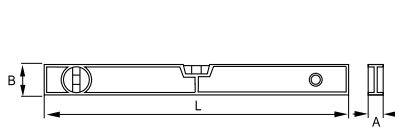

- Aluminium tube, light, 450 g/m
- Tube is slim, easy to carry, size 20 x 49 mm
- Accuracy ± 1 mm
- High visibility vials
- Three vials: horizontal, vertical and 45°
- Protective end caps
- Long lasting epoxy painting
- SET includes: 600, 1200 and 2000 sizes

R	Icon	A mm	B mm	L mm	g
981-400-1	1	20	49	400	175
981-600-1	1	20	49	600	215
981-800-1	1	20	49	800	275
981-1000-1	1	20	49	1.000	325
981-1200-1	1	20	49	1.200	380
981-1500-1	1	20	49	1.500	480
981-1800-1	1	20	49	1.800	550
981-2000-1	1	20	49	2.000	605
981-SET	1	600 + 1200 + 2000 mm			1.200

- Aluminium tube
- Tube is slim, easy to carry, size 22 x 49 mm
- Accuracy ± 0.5 mm
- High visibility vials
- Three vials: horizontal, vertical and 45°
- Two built in magnets
- Protective end caps
- Long lasting epoxy painting

R	Icon	A mm	B mm	L mm	g
981-400M-1	1	22	49	400	300
981-600M-1	1	22	49	600	450

SET OF LEVELS



- Set of 2 levels
- 600 mm Spirit level
- Accuracy ± 1 mm
- Raw material density of 529 g/m
- High visibility and low density liquid inside the vials
- Torpedo level 982-TOR

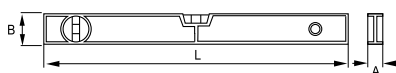

R	Icon	A mm	B mm	L mm	g
982-SET	1	55	60	600	410

TORPEDO LEVEL



- Magnet in the base
- Suitable for plumbers
- 3 vials: horizontal, vertical and 45°
- ± 1 mm accuracy in horizontal vial
- ± 1 mm accuracy in vertical vial
- High visibility liquid inside the vials

Q	Icon	A mm	B mm	L mm	g
982-TOR-1	1	15	40	230	80

POCKET SPIRIT LEVEL, 100 MM

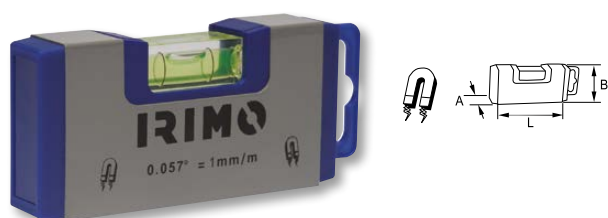

- Pocket level 10 cm
- Accuracy ± 1 mm
- High visibility, barrel shape acrylic vials
- Removable hanging clip
- Long lasting epoxy painting
- 2 strong magnets hidden inside profile, they hold 500 g
- Profile 1.0 mm thickness and weight of 295 g/m

Q	Icon	A mm	B mm	L mm	g
982-10-1	1	20	50	100	60

ALUMINUM LEVEL WITH HOLSTER



- Strong magnet with neodyms
- High quality glued vials
- With textile pouch for easy transport

Q	Icon	Dimensions	g
983-25-1	5	240 x 140 x 25	315

MEASURING TAPES

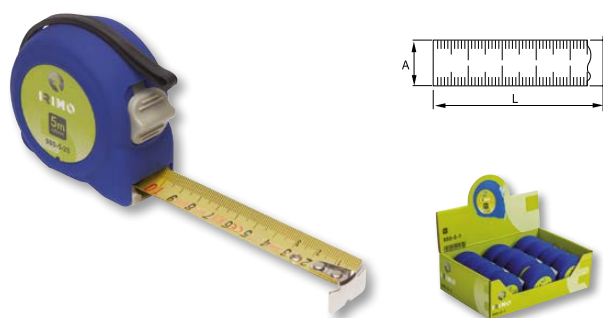

- According to EU Measuring Instruments Directive
- Class II accuracy
- ABS case with thermo rubber coating
- Blade locking system
- Wrist strap
- Metal belt clip
- High quality 50C steel blade
- 3 rivets on stopper
- Display: for 12 units orders

Q	Icon	A mm	L m	g
980-3-1	12	16	3	140
980-5-1	12	19	5	180
980-5-25-1	12	25	5	175



- According to EU Measuring Instruments Directive
- Class II accuracy
- ABS case with thermo rubber coating
- Blade locking system
- Wrist strap
- Metal belt clip
- High quality 50C steel blade
- 3 rivets on stopper
- Display: for 12 units orders

Q	Icon	A mm	L m	g
980-3B-1	12	16	3	125
980-5B-1	12	19	5	195
980-8B-1	12	25	8	370



MEASURING TAPES

TAPE TWINPACK



- Measuring tapes Twin pack mm
3 m x 16 mm & 10 m x 25 mm

€	Icon	Icon	Icon	g
980-TP2-1	12	2	170 x 80 x 42	549

HIGH VISIBILITY MEASURING TAPES

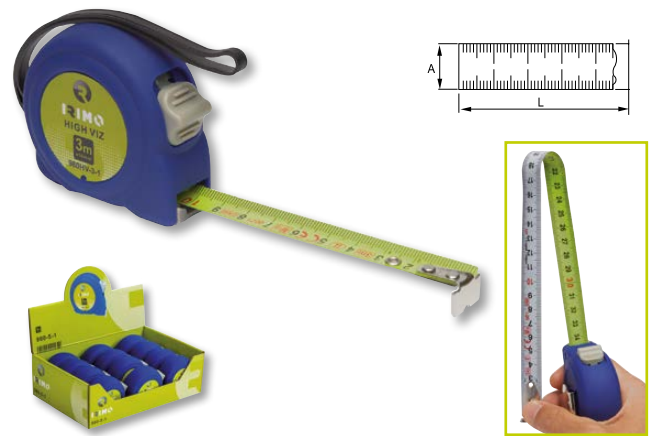

- Special green color of the blade for high visibility
- Vertical marking in the back side
- Back side marking allows easy vertical measurement and marking
- According to EU Measuring Instruments Directive
- Class II accuracy
- ABS case with thermo rubber coating
- Blade locking system
- Wrist strap
- Metal belt clip
- High quality 50C steel blade nylon coated resistant to abrasion
- 3 rivets on stopper hook
- Display: for 12 units orders

€	Icon	A mm	L m	g
980HV-3-1	12	16	3	105
980HV-5-1	12	19	5	175

MEASURING TAPE WITH TRANSPARENT CASE

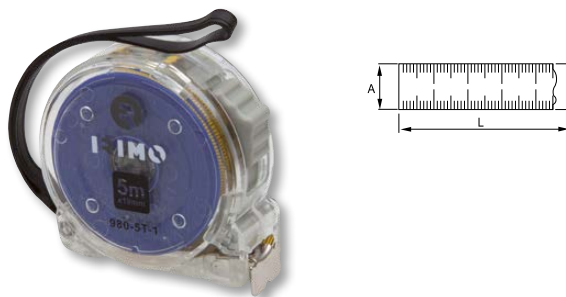

- Double side printing mm only
- According to EU Measuring Instruments Directive
- Class II accuracy
- ABS transparent case, highly resistant to impact
- High quality 50C steel blade nylon coated resistant to abrasion
- 3 rivets on stopper hook
- Blade locking system
- Wrist strap
- Metal belt clip
- Retail packaging
- Display: for 12 units orders

€	Icon	A mm	L m	g
980-5T-1	12	19	5	190

MEASURING TAPE FOR VERTICAL MEASUREMENTS

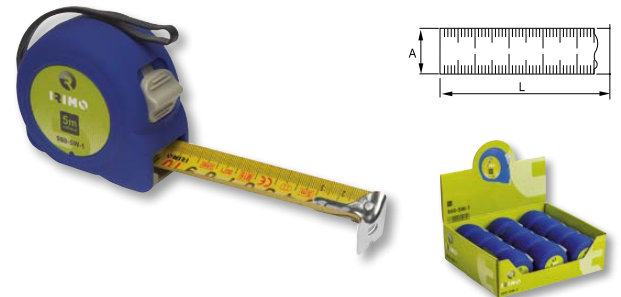

- Measuring tape 5 m x 30 mm wide
- Marked in mm in both sides
- Vertical marking in the back
- Display: for 12 units orders

€	Icon	A mm	L m	g
980-5W-1	12	30	5	295

LONG TAPE

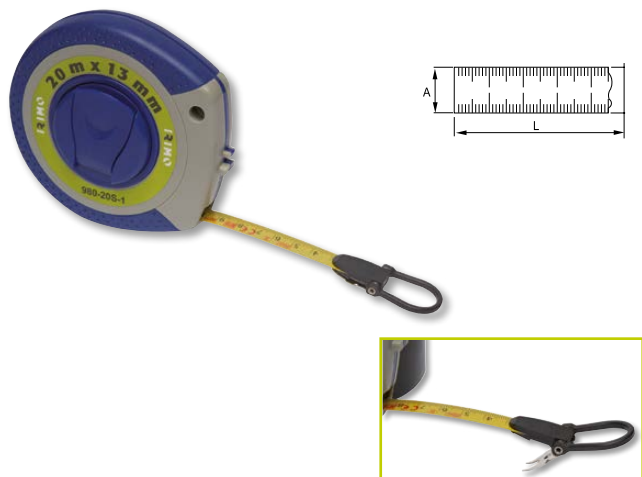

- According to EU Measuring Instruments Directive
- Class II accuracy
- ABS case with thermo rubber grip
- High quality 50C steel blade
- Stopper with ring and foldable jaw
- Belt clip
- Quick wind mechanism
- Individual box that can be hung

Q		A mm	L m	g
980-20S-1	12	13	20	350

WOODEN FOLDING RULE



- 10 blades wooden folding rule
- Birch wood, flexible and resistant
- Special varnish resistant to abrasion
- According to EU Measuring Instruments Directive
- Class III

Q		A mm	L m	g
985-2-1	1	16	2	115

SQUARES

SQUARES



- Scale in mm
- Stainless steel blade
- Aluminium handle

Q		L mm	g
991-200-1	1	200	230
991-250-1	1	250	250
991-300-1	1	300	290
991-400-1	1	400	330

COMBINATION SQUARES



- Scale in mm and inches
- Stainless steel blade
- Includes a level with 1 mm/m accuracy
- Zinc handle and brass parts

Q		L mm	g
993-150-1	1	150	200
993-300-1	1	300	230
993-400-1	1	400	260



GAUGE SETS

SCREW PITCH GAUGE SET



- Blade length: 70 mm

972-52-1	25	52 blades	65
Metric 60° - 0.25 to 6 mm			
0.25-0.30-0.35-0.40-0.45-0.50-0.60-0.70-0.75-0.80-0.90-1-1.25-1.50-1.75-2-2.5-3-3.5-4-4.5-5-5.5-6			
Whitworth 55° - 4 a 62 thread"			
4-4.5-5-6-7-8-9-10-11-12-13-14-16-18-19-20-22-24-25-26-28-30-32-36-40-48-60-62			

FEELER GAUGE SETS



- Blade length: 100 mm

971-13-1	5	13 blades	52
0.05 to 1 mm			
0.05-0.10-0.15-0.20-0.25-0.30-0.40-0.50-0.60-0.70-0.80-0.90-1			
971-20-1	5	20 blades	83
0.05 to 1 mm			
0.05-0.10-0.15-0.20-0.25-0.30-0.35-0.40-0.45-0.50-0.55-0.60-0.65-0.70-0.75-0.80-0.85-0.90-0.95-1			

CALIPERS

VERNIER CALIPER 150 MM



- Vernier caliper
- Accuracy ± 0.03 mm
- Made in hardened stainless steel
- Includes thread chart
- Includes plastic box for safe storage

984-6-1	1	0-150	0-6"	235	25 x 90 x 245	150

DIGITAL VERNIER CALIPER 150 MM



- Digital Vernier caliper
- Accuracy ± 0.03 mm
- Made in hardened stainless steel
- Includes thread chart
- Includes plastic box for safe storage

984-6D-1	1	0-150	0-6"	235	25 x 90 x 245	150

INFRARED THERMOMETER



- Non contact measuring temperature
- Measuring range: -50° to 420° (-58°F to 788°F)
- With laser pointer
- Accuracy: 0° to 420°, ± 1.5°
- -50° to 0°, ± 3°
- Resolution: 0.1°
- Repeatability: 1% of reading or 1°
- Response time: 500 ms
- Measuring cone ratio: L12 to D1
- 9V battery not included

LI-420-1	1	155	170

FASTENING TOOLS

CAULKING GUNS

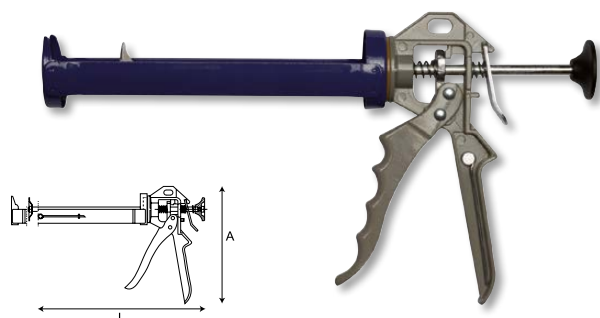

- Caulking gun for 9" cartridges
- Suitable for most grades of resins and glues
- Handle and trigger made of high quality aluminium
- Rotary skeleton for easy loading
- Needle incorporated for cleaning
- Thrust ratio 7:1
- Maxium push force 1500N

Q	Box	A mm	L mm	g
549-230-2	1	200	330	550

ELECTRONIC GLUE GUN SET



- Industrial performance glue gun
- With ON-OFF switch for energy saving
- CE/GS Standards
- Protected nozzle for added safety, reliability and extended life
- 2 additional nozzles (spreader & precision) with a valve to prevent unintentional glue drop
- Foldable stand for safe, handy storage while in use
- Power: 80W. Voltage: 220-240V. Preheat time: 3-5 minutes. Flow of glue: 14-15 g per minute. 1,6 m cord
- 12 pcs of 11.2x150 mm glue stick (6 x General Purpose glue sticks, 6 x Super Strength glue sticks)
- Blister pack

Q	Box	Dimensions	g
550-80-4	1	40x190x190	250

PAINT SCRAPERS

PAINT SCRAPERS



- Flexible carbon steel ground blade
- 1.5 mm thickness/0.5 mm at the tip
- Excellent flexibility and maximum durability
- Polished and varnished blade for longer life
- Metallic ring for perfect fixing between handle and blade
- Comfortable and light plastic handle
- Provided with hanging hole
- Standards: DIN 7216, UNE 16608

Q	Box	S mm	L mm	g
540021	12	20	220	50
540031	12	30	220	55
540041	12	40	220	60
540051	12	50	220	65
540061	12	60	220	70
540071	12	70	220	75
540081	12	80	220	80
540091	12	90	220	85
540101	12	100	220	90
540121	12	120	220	100

BODY WORK SCRAPER SET



- Bodywork scraper set, 4 pcs
- Dimensions: 90x50 mm, 120x80 mm, 120x105 mm, 120x120 mm
- Carbon steel ground blade
- Excellent flexibility and maximum durability
- Polished and varnished blade to prevent oxidation
- Supplied in a plastic pouch

Q	Box	Quantity	Dimensions	g
536011	1	4	160x130	120

90x50 mm, 120x80 mm, 120x105 mm, 120x120 mm



STAPLERS

HEAVY DUTY STAPLE GUN 4 IN 1



- Compact, multi-purpose stapler and brad nail stapler gun
- High-low power setting to control intensity application
- Fastener window provides clear visibility to determine when staple reload is required
- Anti-jam mechanism for continuous use and reliable operation
- Lock down handle for safe storage and transportation
- Belt clip
- Compatible with:
 - Heavy duty staples (1.2): 6-14 mm (1/4"-9/16")
 - Light duty staples (0.7): 6-14 mm (1/4"-9/16")
 - Cable staples: 10-14 mm (3/8"-9/16")
 - 18 ga. brad nails: 15 mm (19/32")

560-41-1	3	170x290x40	690

HEAVY DUTY STAPLES

x1000



- For heavy duty stapling jobs such as insulation, carpets or roofing felt
- Staples suitable for fabrics, cloths, carpets, cardboard, flat wooden slats, wooden cardboard and metal mesh

		A mm	B mm	C mm		
560-HD-06	12	1,2	11,3	6	40x28x80	110
560-HD-08	12	1,2	11,3	8	65x35x80	137
560-HD-10	12	1,2	11,3	10	65x35x80	158
560-HD-12	12	1,2	11,3	12	65x35x80	172
560-HD-14	12	1,2	11,3	14	65x35x80	195

BRAD NAILS 15 MM

x1000



- Suitable brad nails for craft or carpentry projects

		A mm	B mm	C mm		
560-BN-15	12	1,2	2	15	40x28x80	122

HAMMER TACKER



- Compact hammer tacker with steel housing
- Anti-jam mechanism for continuous use and reliable operation
- Ergonomic handle for better grip and handling

560-HT-1	6	115x350x32	520

LIGHT DUTY STAPLES

x1000



- Suitable staples for light duty household and crafting stapling jobs

		A mm	B mm	C mm		
560-LD-06	12	0,7	10,6	6	40x28x80	70
560-LD-08	12	0,7	10,6	8	65x35x80	88
560-LD-10	12	0,7	10,6	10	65x35x80	102
560-LD-12	12	0,7	10,6	12	65x35x80	112
560-LD-14	12	0,7	10,6	14	65x35x80	117

CABLE STAPLES

x1000



- Suitable staples for low voltage wires

		A mm	B mm	C mm		
560-CA-10	12	1,2	6,3	10	65x35x80	127
560-CA-12	12	1,2	6,3	12	65x35x80	145
560-CA-14	12	1,2	6,3	14	65x35x80	151



12. LIGHTING & PNEUMATIC TOOLS

POCKET LAMPS

FLEXIBLE LIGHT



- LED COB (main) / 1xSMD (torch)
- LUMENS: 400 lm (main) / 70 lm (torch)
- Battery:
 - Material: Li-ion 3.7V 2000mAh
 - Operating time: 3 h (main) / 10 h (torch)
 - Charging time: 3 h
 - Charging port: Micro USB
- Two light intensity options
- Micro USB cable 1m included
- Temperature: 5700 K
- CRI: >70
- IP54 / IK07
- CE-EMC / RoHS / Reach

L-FLEX-1	1	400	70	✓	3/10	3.5	74 x 262 x 45 307

COMPACT



- LED COB (main) / 1xSMD (torch)
- LUMENS: 600 lm (main) / 100 lm (torch)
- Battery:
 - Material: Li-ion 3.7V 2000mAh
 - Operating time: 2.5 h (main) 6 h (torch)
 - Charging time: 3 h
 - Charging port: Micro USB
- Micro USB cable 1 m included
- Temperature: 5700 K
- CRI: >80
- IP54 / IK07
- CE-EMC / RoHS / Reach

L-COMP-1	1	600	100	✓	2.5/6	3	75 x 207 x 38 223

SLIM FLEX



- LED COB (main) / 1xSMD (torch)
- LUMENS: 400 lm (main) / 70 lm (torch)
- Battery:
 - Material: Li-ion 3.7V 2000mAh
 - Operating time: 3-8 h (main) 8 h (torch)
 - Charging time: 3 h
 - Charging port: Micro USB
- Thumbwheel light intensity regulator
- Micro USB cable 1 m included
- Temperature: 5700 K
- CRI: >70
- IP20 / IK07
- CE-EMC / RoHS / Reach

L-SLIM-1	1	400	70	✓	3/8	3	82 x 168 x 36 200

MINI FLEXIBLE LIGHT



- LED SMD 4+1
- LUMENS: 250 lm (main) / 70 lm (torch)
- Battery:
 - Material: Li-ion 3.7V 1000mAh
 - Operating time: 3 h (main) 7 h (torch)
 - Charging time: 3 h
 - Charging port: Micro USB
- Micro USB cable 1m included
- Temperature: 5700 K
- CRI: >80
- IP20 / IK07
- CE-EMC / RoHS / Reach

L-MINI-1	1	250	70	✓	3/7	3	53 x 195 x 53	130

POCKET FLEX LIGHT



- LED SMD 4+1
- LUMENS: 250 lm (main) / 70 lm (torch)
- Battery:
 - Material: Li-ion 3.7V 1000mAh
 - Operating time: 2-2.5 h (main) 6 h (torch)
 - Charging time: 3 h
 - Charging port: Micro USB
- Micro USB cable 1m included
- Temperature: 5700 K
- CRI: >80
- IP20 / IK07
- CE-EMC / RoHS / Reach

L-POCK-1	1	250	70	✓	2.5/6	3	73 x 138 x 45	220

INSPECTION LAMPS

ALUMINIUM TORCH



- LED COB
- LUMENS: 100 lm
- Battery:
 - 3AAA included
 - Operating time: 9 h
- Aluminium body
- Easy push rubber button
- Strap to hang it
- Temperature: 6500 K
- CRI: >70
- IP44
- CE-EMC / RoHS

L-ALUM-1	1	100	3AAA	100 x 45 x 35	100
L-ALUM-12DISP	1			105 x 220 x 170	1.050

PEN LIGHT



- LED SMD 6+1
- LUMENS: 150 lm (main) / 70 lm (torch)
- Battery:
 - Material: Li-ion 3.7V 600mAh
 - Operating time: 2.5 h (main) 3.5 h (torch)
 - Charging time: 2 h
 - Charging port: USB C type
- Micro USB cable 1m included
- Temperature: 5700 K
- CRI: >80
- IP20 / IK07
- CE-EMC / RoHS / Reach

L-PEN-1	1	150	70	✓	2.5/3.5	2	39 x 164 x 18	390



WORKING LAMPS

BOOK LIGHT



- LED 27xSMD
- Two intensity options
- LUMENS: 500 lm / 1000 lm
- Battery:
 - Material: Li-ion 3.7V 4000mAh
 - Operating time: 6 h / 500 lm, 3 h / 1000 lm
 - Charging time: 2.5-3 h / 5V 2A
 - Charging port: Micro USB
- Power bank functionality
- Rotating handle 270°
- Micro USB cable 1 m included
- Temperature: 6000 K
- CRI: >80
- IP54 / IK08
- CE-EMC / RoHS / Reach



L-BOOK-1	1	500/1000	3/6	3	182 x 142 x 52	400

HEAD LAMPS

HEAD LIGHT



- LED SMD
- LUMENS: 400 lm
- Battery:
 - Material: Li-ion 3.7V 2200mAh
 - Operating time: 5 h
 - Charging time: 4 h
 - Charging port: Micro USB
- Two intensity and blinking option in the front
- Rear red light with blinking option
- Adjustable strap
- Swiveling head
- Zoom for better focus
- Micro USB cable 1 m included
- Temperature: 6000 K
- CRI: >70
- IP44
- CE-EMC / RoHS / Reach

L-HEAD-1	1	5	4	118 x 87 x 64	125

3/8" IMPACT WRENCH

P704

MAX
Nm 150



3/4" IMPACT WRENCH

P817

kg 3.95



1/2" IMPACT WRENCH

P800

MAX
Nm 600



P815

MAX
Nm 825



- Using the most modern materials composite
- Lightweight and low vibration

	QTY	SIZE	BAR	INCH	MM	INCH	MM	MAX Nm	rpm	mm³	mm³	mm	kg	
P704	1	3/8"	6.3	1/4" - 18	10	127	55 - 120	150	10.000	1.200	89.00	5.92	160	0.90
P800	1	1/2"	6.3	1/4" - 18	10	99	100 - 570	600	7.500	1.300	90.00	2.57	192	2.40
P815	1	1/2"	6.3	1/4" - 18	10	130	320 - 620	825	7.000	1.150	84.00	5.00	192	1.95
P817	1	3/4"	6.3	3/8" - 18	10	190	340 - 950	1.800	4.500	970	88.00	4.30	245	3.95

1" IMPACT WRENCH

MAX
Nm 2.500



- Long anvil
- 6"-150 mm
- For trucks

	QTY	SIZE	BAR	INCH	MM	INCH	MM	MAX Nm	rpm	mm³	mm³	mm	kg	
P802	1	1"	6.3	1/2" - 14	13	416	950 - 2.030	2.500	3.800	500	98.00	<2.50	550	14.40



1/4" RATCHET

P700

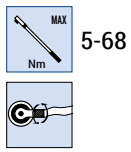

1/2" RATCHET

P821



• Composite

	QTY	BAR	inch	mm	Nm	rpm	kg
P700	1	1/4"	6.3	1/4" - 18	10	136	0.50
P821	1	1/2"	6.3	1/4" - 18	10	120	1.20

BLOW GUN



	QTY	BAR	kg
P218	1	6.3	135

AIR LINE COUPLERS



PM5002
PM5003



PM5012
PM5013



PM5142
PM5143



PM5152
PM5153



PM5248

	QTY	inch	mm	g
PM5002 PM5003	1	1/4" 3/8"	Male Male	70
PM5012 PM5013	1	1/4" 3/8"	Female Female	80
PM5142 PM5143	1	1/4" 3/8"	Male Male	20
PM5152 PM5153	1	1/4" 3/8"	Female Female	20
PM5248	1	-	For 8 mm hose	10

1/4" QUICK CONNECTOR



- Works with 4 standard male connector profiles
- Security lock enabling the operator to turn the airflow on and off, providing a safer and more simplified operation
- Steel construction with composite coating, making it extremely durable

	QTY	BAR	inch	kg
PQCF14	10	1.600	1/4"	0.100

IN LINE LUBRICATOR



- Install either in the tool air input, or in the 1/4" hose thread

	QTY	inch	kg
PN251	1	1/4"	0.10

FILTER REGULATOR



- When compressing atmospheric air, which always has a humidity rate, liquid water is generated in the pneumatic circuits. It is necessary to filter this water to protect the circuit and the air operated tools
- Use an air filter and regulator for the spray guns
- Technical data:
 - Air connection 1/2"
 - Bowl capacity 100 ml
 - Gauge diameter 50 mm
 - Pressure regulation range 0.5-10 bar
 - Minimum temperature +5°
 - Maximum temperature 60°
 - Nominal flow 3.200 NL/mn
 - Filtering size 20 m

P254	1	1.04

FILTER REGULATOR LUBRICATOR



- When compressing atmospheric air, which always has a humidity rate, liquid water is generated in the pneumatic circuits. It is necessary to filter this water to protect the circuit and the air operated tools
- For the rest of pneumatic tools used in repair or body shop, it is necessary to use an air filter, regulator and lubricator
- Technical data:
 - Air connection 1/2"
 - Bowl capacity 100 ml
 - Gauge diameter 50 mm
 - Pressure regulation range 0.5-10 bar
 - Minimum temperature +5°
 - Maximum temperature 60°
 - Nominal flow 3.200 NL/mn
 - Filtering size 20 m

P255	1	1.42

CORDLESS SCREWDRIVER

3.6V CORDLESS SCREWDRIVER



- 3.6V Li-ion rechargeable battery
- 1/4" hex quick release bit holder
- 6+1 torque positions
- LED light to lighten the working area
- 4 LED lamp to work as a regular torch
- Adaptable handle in straight or pistol shapes
- One hand forward/reverse change
- Integrated colour LEDs to know the battery status
- 4 screwdriver bits included
- Packed in a retail color cardboard box

3.6SDR	1	3.6	95x65x35	200	400



- The IRIMO exhibitors are a perfect solution that contributes to improving the point of sale management.
- With their attractive design, these displays will help enhance the image of the store.
- This solution facilitates stock control and at the same time, optimize display space.

NOTE: Below are some examples; for more information about different accessories and sizes, please contact us and we will offer the ideal solution suited to your needs.



MEE-SIGN-CARR-I SIGN CARRIER+SIGN IRIMO (100 cm)

MEE-1S2L-B-I METAL WALL_1SIDE_2LEG_BAHC&IRI

* Tools not included

POINT OF SALE MATERIAL

METAL WALL 1 SIDE 2 LEGS

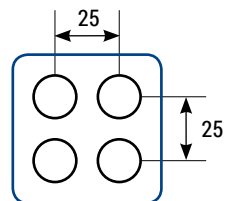

Perforated wall detail

IRIMO	W mm	H mm	L mm	kg
MEE-1S2L-B-I	524	2250	1030	53.63

LIGHTBOX



- Short cable is included
- Order long cable separately (PEE-LCABLE-B-I)

IRIMO	W mm	H mm	L mm	kg
MEE-LIGHTBOX-I	412	170	1000	13.32

SIGN CARRIER + SIGN IRIMO



IRIMO	W mm	H mm	L mm	kg
MEE-SIGN-CARR-I	90	200	1000	1.98

METAL WALL CORNER 1 LEG

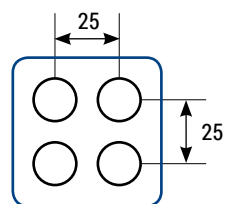
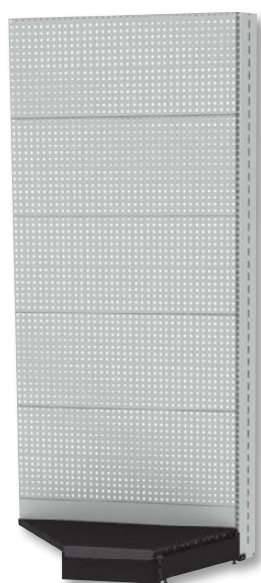

Perforated wall detail

IRIMO	W mm	H mm	L mm	kg
MEE-COR-1L-B-I	388	2350	941	44.05

LIGHTBOX CORNER WALL



- Short cable is included
- Order long cable separately (PEE-LCABLE-B-I)

IRIMO	W mm	H mm	L mm	kg
MEE-COR-LIGHT-I	400	174	910	7.375

POINT OF SALE MATERIAL

SPARE PARTS FOR METAL WALL

METHACRYLATE FOR LIGHTBOX



IRIMO	W mm	H mm	L mm	kg
PEE-METHACRYL-I	3	168	980	0.61

PVC TOP SIGN FOR SIGN CARRIER



IRIMO	W mm	H mm	L mm	kg
PEE-SIGN-DB-W-2	3	150	980	0.2

TOP SIGN FOR DOUBLE SIDED WALL



IRIMO	W mm	H mm	L mm	kg
PEE-TOPSIGN-I	3	150	980	0.2

DOUBLE SIDE WALL WITH WHEELS

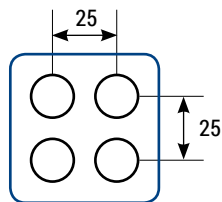
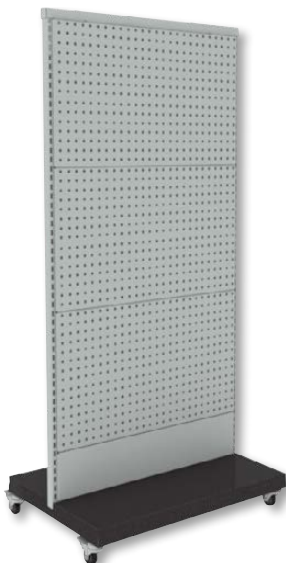

Perforated wall detail

IRIMO	W mm	H mm	L mm	kg
MEE-DB-W-NL	300	800	1390	29.99

BANNER FOR METAL WALLS



IRIMO	W mm	H mm	L mm	kg
MEE-BANNER-I	15	1200	230	1.025

STICKERS A4 SHEET



IRIMO	W mm	L mm	kg
PPOS-A4-STICK-I	210	295	0.018

TRIANGULAR METAL WALL WITH WHEELS

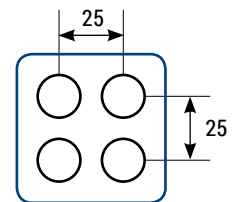
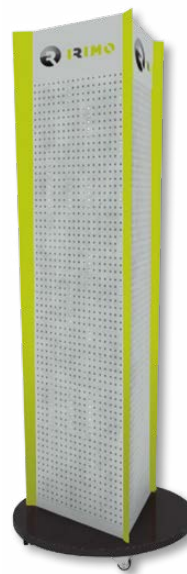

Perforated wall detail

IRIMO	W mm	H mm	L mm	kg
MEE-TR-W-I	700	1860	700	23.45

ADDITIONAL POS MATERIAL. EMPTY DISPLAYS

GENERIC COUNTER DISPLAY



IRIMO	W mm	H mm	L mm	kg
MEE-COUNT-IR-1	295	615	430	6.7

COUNTER S DISPLAY



- The display includes 12 hooks of 240 mm length each one

IRIMO	W mm	H mm	L mm	kg
MEE-COUNT-IR-2	260	465	465	2.6

COUNTER L DISPLAY



- The display includes 22 hooks of 240 mm length each one

IRIMO	W mm	H mm	L mm	kg
MEE-COUNT-IR-3	270	465	775	4.12

PALLET COVER EUROPALET



IRIMO	W mm	H mm	L mm	kg
PEE-PC-IR-1	1150	250	800	0.735

COUNTER DISPLAY PLIERS, 20 pieces



IRIMO	W mm	H mm	L mm	kg
PEE-COUNT-006	280	240	365	0.23

COUNTER DISPLAY PLIERS, 5 pieces



IRIMO	W mm	H mm	L mm	kg
CEE-COUNT-IR-1	200	60	90	0.237

STAND ALONE





- Material: metal and plastic
- Color: black and green
- The display can be used to expose 3 different socket sets: small - medium - big
- The following socket sets can be exposed:
 - Small socket set (109-35-4)
 - Medium socket set (119-18-4 or 129-23-4)
 - Big socket set (129-58-4 or 129-101-4)
- Includes 3 wall racks with a methacrylate cover
- Delivered already mounted & empty

IRIMO	kg	Dimensions
MEE-SA-SS-IR	1	1835 x 455 x 380

🔍	📖	🔍	📖	🔍	📖
001021	36	045001	113	055071	47
001031	36	045011	113-115	055091	47
001041	36	045021	113	055121	47
001051	36	045031	113	055141	47
001061	36	045041	113-115	055171	47
001071	36	045051	113	055181	47
001081	36	045061	113	055201	47
020011	44	045071	113	055211	47
020031	44	045081	113	055221	47
020051	44	045091	113	055241	47
020071	44	045101	113	055251	47
020091	44	045121	113	055301	47
020121	44	045141	113	055311	47
020141	44	045171	113	056231	47
020171	44	045191	113-115	056271	47
020181	44	045221	113	066-400-1	167
020201	44	045541	115	070411	52
020211	44	045561	115	070421	52
020221	44	045581	115	070431	52
020241	44	045601	115	070441	52
020251	44	045611	115	070451	52
021221	44	045621	115	070461	52
021251	44	045641	115	070471	52
040001	112	045661	115	070481	52
040011	112	045681	115	10-0405-1	37
040021	112	045701	115	10-0607-1	37
040031	112	045731	115	10-0809-1	37
040041	112	045801	115	10-1011-1	37
040051	112	045811	115	10-1013-1	37
040061	112	045821	115	10-12-H	38
040071	112	045831	115	10-12-W	38
040081	112	045841	115	10-1213-1	37
040091	112	045851	115	10-1415-1	37
040101	112	045861	115	10-1617-1	37
040121	112	045871	115	10-1719-1	37
040141	112	045881	115	10-1819-1	37
040171	112	045891	115	10-2022-1	37
040191	112	045901	115	10-2123-1	37
040221	112	045921	115	10-2224-1	37
040541	112	045941	115	10-2426-1	37
040561	112	046011	114	10-2427-1	37
040581	112	046021	114	10-2528-1	37
040601	112	046031	114	10-2729-1	37
040611	112	046041	115	10-3032-1	37
040621	112	046051	115	10-8-H	38
040641	112	046061	115	101-04-1	56
040661	112	046091	114	101-045-1	56
040681	112	046101	114	101-05-1	56
040701	112	047001	116	101-055-1	56
040731	112	047011	116	101-06-1	56
041011	112	047021	116	101-07-1	56
041021	112	047031	116	101-08-1	56
041031	112	047041	116	101-09-1	56
041041	112	047051	116	101-10-1	56
041051	112	047061	116	101-11-1	56
041061	112	047081	116	101-12-1	56
041071	112	047101	116	101-13-1	56
041091	112	047121	116	101-14-1	56
041101	112	055011	47	101A-05-1	56
041111	113	055031	47	101A-06-1	56
041121	113	055051	47	101A-07-1	56



Q	📖	Q	📖	Q	📖
101A-08-1	56	107-T08-1	57	121-11-1	64
101A-09-1	56	107-T09-1	57	121-12-1	64
101A-10-1	56	107-T10-1	57	121-13-1	64
101A-11-1	56	107-T15-1	57	121-14-1	64
101A-12-1	56	107-T20-1	57	121-15-1	64
101A-14-1	56	107-T25-1	57	121-16-1	64
101A-16-1	56	107-T27-1	57	121-17-1	64
101A-18-1	56	107-T30-1	57	121-18-1	64
103-04-1	56	107-T40-1	57	121-19-1	64
103-045-1	56	107A-4-1	57	121-20-1	64
103-05-1	56	107A-5-1	57	121-21-1	64
103-055-1	56	107A-6-1	57	121-22-1	64
103-06-1	56	107A-7-1	57	121-23-1	64
103-07-1	56	109-11-4	58	121-24-1	64
103-08-1	56	109-13-4	58	121-25-1	64
103-09-1	56	109-19-4	60	121-26-1	64
103-10-1	56	109-23-4	60	121-27-1	64
103-11-1	56	109-35-4	60	121-28-1	64
103-12-1	56	112-06-1	61	121-30-1	64
103-13-1	56	112-07-1	61	121-32-1	64
103-14-1	56	112-08-1	61	121-34-1	64
103A-06-1	56	112-09-1	61	121-36-1	64
103A-08-1	56	112-10-1	61	122-08-1	64
103A-09-1	56	112-11-1	61	122-09-1	64
103A-10-1	56	112-12-1	61	122-10-1	64
103A-11-1	56	112-13-1	61	122-11-1	64
103A-12-1	56	112-14-1	61	122-12-1	64
103A-14-1	56	112-15-1	61	122-13-1	64
103A-16-1	56	112-16-1	61	122-14-1	64
105-22-1	59	112-17-1	61	122-15-1	64
105-24-1	59	112-18-1	61	122-16-1	64
105-26-1	59	112-19-1	61	122-17-1	64
105-28-1	59	112-20-1	61	122-18-1	64
105-40-1	59	112-21-1	61	122-19-1	64
105-42-1	59	112-22-1	61	122-20-1	64
105-46-1	59	113-07-1	61	122-21-1	64
105-48-1	59	113-08-1	61	122-22-1	64
105-50-1	59	113-09-1	61	122-23-1	64
105-70-1	58	113-10-1	61	122-24-1	64
105-70-12DISP	58	113-11-1	61	122-27-1	64
105501	58	113-12-1	61	122-30-1	64
106-04-1	56	113-13-1	61	122-32-1	64
106-05-1	56	113-14-1	61	122-34-1	64
106-06-1	56	113-16-1	61	122-36-1	64
106-07-1	56	113-17-1	61	122A-10-1	64
106-08-1	56	113-19-1	61	122A-11-1	64
106-10-1	56	115-20-1	62	122A-12-1	64
107-0840-1	57	115-22-1	62	122A-14-1	64
107-1055-1	57	115-24-1	62	122A-16-1	64
107-1280-1	57	115-40-1	63	122A-18-1	64
107-H3-1	57	115-42-1	62	122A-20-1	64
107-H4-1	57	115-43-1	62	122A-22-1	64
107-H5-1	57	115-44-1	63	122A-24-1	64
107-H6-1	57	115-46-1	63	122A-26-1	64
107-H8-1	57	115-48-1	63	122A-28-1	64
107-PH1-1	57	115-70-1	62	122A-30-1	64
107-PH2-1	57	115501	62	122A-34-1	64
107-PH3-1	57	119-18-4	63	122A-38-1	64
107-PZ1-1	57	121-08-1	64	122A-40-1	64
107-PZ2-1	57	121-09-1	64	124-10-1	65
107-PZ3-1	57	121-10-1	64	124-11-1	65

Q		Q		Q	
124-12-1	65	131-25-1	74	139-21B-4	77
124-13-1	65	131-26-1	74	1467-A01	158
124-14-1	65	131-27-1	74	149-164-4	74
124-15-1	65	131-28-1	74	15-0607-1	45
124-16-1	65	131-29-1	74	15-0809-1	45
124-17-1	65	131-30-1	74	15-1011-1	45
124-18-1	65	131-32-1	74	15-12-W	45
124-19-1	65	131-33-1	74	15-1213-1	45
124-21-1	65	131-34-1	74	15-1415-1	45
124-22-1	65	131-35-1	74	15-1617-1	45
124-24-1	65	131-36-1	74	15-1719-1	45
124-27-1	65	131-38-1	74	15-1819-1	45
124-30-1	65	131-40-1	74	15-2022-1	45
124-32-1	65	131-41-1	74	15-2123-1	45
124A-18-1	65	131-42-1	74	15-2426-1	45
124A-20-1	65	131-46-1	74	15-2427-1	45
124A-22-1	65	131-50-1	74	15-2528-1	45
124A-24-1	65	131-55-1	74	15-2729-1	45
124A-26-1	65	131-60-1	74	15-3032-1	45
125-22-1	68	131B-19-2	75	15-3236-2	45
125-23-1	68	131B-21-2	75	15-3641-2	45
125-25-1	68	131B-22-2	75	15-8-H	45
125-40-1	70	131B-23-2	75	15-8-W	45
125-42-1	69	131B-24-2	75	160-07-1	77
125-43-1	69	131B-26-2	75	160-08-1	77
125-44-1	69	131B-27-2	75	160-10-1	77
125-46-1	69	131B-29-2	75	160-11-1	77
125-48-1	70	131B-30-2	75	160-12-1	77
125-49-1	69	131B-32-2	75	160-13-1	77
125-52-1	68	131B-35-2	75	160-14-1	77
125-53-1	69	131B-36-2	75	160-15-1	77
125-54-1	69	131B-38-2	75	160-16-1	77
125-60-1	69	131B-41-2	75	160-17-1	77
125-70-1	67	131B-46-2	75	160-18-1	77
125-70-12DISP	68	131B-50-2	75	160-19-1	77
125501	67	132A-28-1	75	160-20-1	77
126-10-1	65	132A-30-1	75	160-21-1	77
126-11-1	65	132A-32-1	75	160-24-1	77
126-12-1	65	132A-34-1	75	161-10-1	77
126-14-1	65	132A-36-1	75	161-13-1	77
126-16-1	65	132A-40-1	75	161-17-1	77
126-18-1	65	132A-42-1	75	162-00-1	78
126-20-1	65	132A-44-1	75	162-02-1	78
126-24-1	65	132A-46-1	75	162-50-1	78
129-10-4	68	132A-48-1	75	162-60-1	78
129-101-4	73	132A-52-1	75	162-65-1	78
129-108-4	72	132A-54-1	75	162931	78
129-12-4	68	132A-60-1	75	162941	78
129-172-4	73	132A-64-1	75	167-08-1	79
129-23-4	70	135-21-1	75	167-10-1	79
129-33W-4	70	135-22-1	75	167-10-4	79
129-58-4	71	135-24-1	75	167-12-1	79
129-9H-4	66	135-40-1	76	167-13-1	79
129-9T-4	66	135-42-1	75	167-14-1	79
129A-103-4	72	135-43-1	76	167-15-1	79
129A-53-4	71	135-46-1	76	167-16-1	79
131-19-1	74	135-52-1	76	167-17-1	79
131-21-1	74	135-70-1	75	167-18-1	79
131-22-1	74	135-85-1	75	167-19-1	79
131-23-1	74	139-17-4	76	167-20-1	79
131-24-1	74	139-21-4	76	167-21-1	79

🔍	📖	🔍	📖	🔍	📖
167-22-1	79	174-21-2	81	18-09-1	41
167-23-1	79	174-22-2	81	18-10-1	41
167-24-1	79	174-24-2	81	18-11-1	41
167-26-1	79	174-27-2	81	18-12-1	41
167-27-1	79	174-30-2	81	18-12-H	42
167-30-1	79	174-32-2	81	18-13-1	41
167-32-1	79	174-33-2	81	18-14-1	41
167-34-1	79	174-34-2	81	18-15-1	41
167-36-1	79	174-36-2	81	18-16-1	41
167-38-1	79	174-41-2	81	18-17-1	41
167-41-1	79	175-01-2	82	18-18-1	41
167-90-2	79	175-02-2	82	18-19-1	41
167-91-2	79	175-10-2	82	18-21-1	41
168-10-1	80	175-25-2	81	18-22-1	41
168-11-1	80	175-60-2	82	18-24-1	41
168-13-1	80	175-65-2	82	18-27-1	41
168-14-1	80	175911	81	18-30-1	41
168-16-1	80	177-10-5	82	18-32-1	41
168-17-1	80	177-22-2	82	18-8-H	41
168-18-1	80	177-24-2	82	180-04-1	66
168-19-1	80	177-27-2	82	180-05-1	66
168-21-1	80	177-30-2	82	180-05X-1	66
168-22-1	80	177-32-2	82	180-06-1	66
168-23-1	80	177-33-2	82	180-06X-1	66
168-24-1	80	177-34-2	82	180-07-1	66
168-27-1	80	177-36-2	82	180-07X-1	66
168-30-1	80	177-38-2	82	180-08-1	66
168-32-1	80	177-41-2	82	180-08X-1	66
168-90-2	80	177-42-2	82	180-10-1	66
169-01-1	80	177-46-2	82	180-10X-1	66
169-02-1	80	177-50-2	82	180-12-1	66
169-03-1	80	177-55-2	82	180-12X-1	66
169-25-1	80	177-60-2	82	180-14-1	66
169-60-1	80	177-65-2	82	180-17-1	66
169-65-1	80	177-70-2	82	180-19-1	66
169921	80	177-75-2	82	183-20-1	66
169931	80	177-80-2	82	183-25-1	66
173-01-5	81	178-22-2	83	183-27-1	66
173-17-2	81	178-24-2	83	183-30-1	66
173-18-2	81	178-27-2	83	183-40-1	66
173-19-2	81	178-30-2	83	183-40X-1	66
173-21-2	81	178-32-2	83	183-45-1	66
173-22-2	81	178-33-2	83	183-45X-1	66
173-23-2	81	178-34-2	83	183-50-1	66
173-24-2	81	178-36-2	83	183-50X-1	66
173-27-2	81	178-38-2	83	183-55-1	66
173-28-2	81	178-41-2	83	183-55X-1	66
173-29-2	81	178-46-2	83	183-60-1	66
173-30-2	81	178-50-2	83	185-05-1	67
173-32-2	81	178-55-2	83	185-06-1	67
173-33-2	81	178-60-2	83	185-06X-1	67
173-34-2	81	179-00-2	83	185-08-1	67
173-36-2	81	179-01-2	83	185-08X-1	67
173-38-2	81	179-02-2	83	185-10-1	67
173-41-2	81	179-52-2	83	185-10X-1	67
173-46-2	81	179-65-2	83	185-12-1	67
173-50-2	81	179931	81-83	185-12X-1	67
173-55-2	81	179941	83	185-14-1	67
173-60-2	81	18-06-1	41	185-16-1	67
174-17-2	81	18-07-1	41	18D-5-H	42
174-19-2	81	18-08-1	41	18S-08-1	42

Q	■	Q	■	Q	■
18S-10-1	42	206-150	88	25-25-1	39
18S-13-1	42	206721	87	25-25-2	39
18S-17-1	42	206741	87	25-26-1	39
18S-19-1	42	206761	87	25-26-2	39
18S-5-H	42	206821	88	25-27-1	39
19-08-1	43	206831	88	25-27-2	39
19-10-1	43	206841	88	25-28-1	39
19-11-1	43	206851	88	25-28-2	39
19-12-1	43	207-100	87	25-29-1	39
19-12-H	43	207-125	87	25-29-2	39
19-13-1	43	207-150	87	25-30-1	39
19-14-1	43	207041	86	25-30-2	39
19-17-1	43	207051	86	25-32-1	39
19-19-1	43	207061	86	25-32-2	39
19-8-H	43	207071	86	25-34-1	39
190-10-135	103	216041	86	25-34-2	39
190-6-135	103	216051	86	25-36-2	39
190-7-135	103	216061	86	25-41-2	39
190-8-135	103	216071	86	25-46-2	39
191-10-175	109	217-50-B	89	25-50-2	39
191-12-175	109	25-06-1	39	25-55-2	39
191-13-175	109	25-06-2	39	25-60-2	39
191-6-150	109	25-07-1	39	25-65-2	39
191-7-175	109	25-07-2	39	25-70-2	39
191-8-175	109	25-08-1	39	25-75-2	39
201231	86	25-08-2	39	25-8-H	40
201241	86	25-09-1	39	25-80-2	39
201251	86	25-09-2	39	25-85-2	39
201261	86	25-10-1	39	25-90-2	39
201431	89	25-10-2	39	25-95-2	39
201451	89	25-100-2	39	254-1200-2	91
201461	89	25-11-1	39	254-150-2	91
201471	89	25-11-2	39	254-300-2	91
202-100	87	25-12-1	39	254-450-2	91
202-125	87	25-12-2	39	254-600-2	91
202-150	87	25-12-H	40	254-900-2	91
202401	87	25-12-W	41	255011	90
202411	87	25-13-1	39	255021	90
202421	87	25-13-2	39	255031	90
202431	87	25-14-1	39	255041	90
202441	87	25-14-2	39	255051	90
202451	87	25-15-1	39	256001	90
202461	87	25-15-2	39	256011	90
202511	88	25-16-1	39	256031	90
202521	88	25-16-2	39	256041	90
202541	88	25-17-1	39	256131	90
202561	88	25-17-2	39	256141	90
202571	88	25-18-1	39	256151	90
202581	88	25-18-2	39	256161	90
202661	89	25-19-1	39	256181	90
202671	89	25-19-2	39	256201	90
202681	89	25-20-1	39	256231	90
202761	89	25-20-2	39	256241	90
202771	89	25-21-1	39	256251	90
202781	89	25-21-2	39	256261	90
202811	88	25-22-1	39	256281	90
202821	88	25-22-2	39	256301	90
202831	88	25-23-1	39	256321	90
202841	88	25-23-2	39	257-200-2	91
206-100	88	25-24-1	39	257-300-2	91
206-125	88	25-24-2	39	257-400-2	91



Q	Q	Q
257-500-2	30-41-2	304S-600-2
257-600-2	30-46-2	304S-900-2
258-100-2	30-50-2	304T-250-2
258-120-2	30-55-2	304T-350-2
258-160-2	30-60-2	304T-450-2
258-200-2	30-65-2	304T-600-2
258-250-2	30-70-2	304T-900-2
258-300-2	30-75-2	307-1122-2
25A-08-1	30-80-2	307-350-2
25A-08-2	30-85-2	307-685-2
25A-10-1	30-90-2	307-940-2
25A-10-2	30-95-2	307S-1122-2
25A-12-1	302-210-2	307S-350-2
25A-12-2	302-260-2	307S-685-2
25A-14-1	302-310-2	307S-940-2
25A-14-2	302-365-2	31-30-2
25A-16-1	302-465-2	31-32-2
25A-16-2	302-615-2	31-36-2
25A-18-1	302-900-2	31-41-2
25A-18-2	302S-210-2	31-46-2
25A-20-1	302S-260-2	31-50-2
25A-20-2	302S-310-2	31-55-2
25A-22-1	302S-365-2	31-60-2
25A-22-2	302S-465-2	31-65-2
25A-24-1	302S-615-2	31-70-2
25A-24-2	302S-900-2	31-75-2
25A-26-1	302T-210-2	31-80-2
25A-26-2	302T-260-2	31-85-2
25A-28-1	302T-310-2	321-42-1
25A-28-2	302T-365-2	321-BLADE-1
25A-30-1	302T-465-2	321161
25A-30-2	302T-615-2	321171
25A-32-1	302T-900-2	321281
25A-32-2	303081	321361
25A-34-1	303111	321501
25A-36-1	303121	321511
25A-40-1	303131	321551
25A-44-1	303171	330021
25A-46-1	303201	332-51-4
25A-48-1	303211	332-52-4
25A-52-1	303221	332S-030-2
25A-58-1	303231	333-003-2
25A-64-1	303241	333-004-2
29-3550-2	303291	333-006-2
29-5080-2	303301	333-008-2
29-80120-2	303311	333-010-2
29P-3550-2	303321	333-012-2
29P-3550-A	303331	333-014-2
29P-5080-2	304-250-2	333-016-2
29P-5080-A	304-350-2	333-018-2
29P-80120-2	304-450-2	333-020-2
29P-80120-A	304-600-2	333-022-2
3.6SDR	304-900-2	333-024-2
30-100-2	304F-250-2	333-026-2
30-24-2	304F-350-2	333-028-2
30-27-2	304F-450-2	333-030-2
30-30-2	304F-600-2	407-10-200
30-32-2	304F-900-2	407-12-250
30-34-2	304S-250-2	407-14-250
30-36-2	304S-350-2	407-4-100
30-38-2	304S-450-2	407-4-75

Q		Q		Q	
407-5.5-100	100	414-7-75	102	457-15-1	117
407-5.5-125	100	414-8-75	102	457-20-1	117
407-6.5-125	100	414-9-75	102	457-25-1	117
407-6.5-150	100	414V-10-100	104	457-27-1	117
407-8-150	100	414V-15-125	104	457-30-1	117
407-8-175	100	414V-20-125	104	457-40-1	117
408-2.5-75	100	414V-25-150	104	457-45-1	117
408-3-100	100	417-10-125	102	457-50-1	117
408-3-200	100	417-11-125	102	457061	117
408-3-75	100	417-12-125	102	457071	117
408-3.5-100	100	417-13-125	102	457081	117
408-4-100	100	417-14-125	102	457091	117
408-4-125	100	417-3.2-125	102	457101	117
408-4-250	100	417-4-125	102	457151	117
408-5.5-125	100	417-4.5-125	102	457201	117
408-5.5-150	100	417-5-125	102	457251	117
408-5.5-25	100	417-5.5-125	102	457271	117
408-5.5-300	100	417-6-125	102	457301	117
408-6.5-150	100	417-7-125	102	457401	117
408-6.5-25	100	417-8-125	102	457451	117
408V-2.5-100	104	417-9-125	102	457501	117
408V-3-100	104	42-H10-200	109	458-02-1	110
408V-3.5-100	104	42-H2-100	108	458-8-F	117
408V-4-100	104	42-H2.5-100	109	458-9-H	117
408V-5.5-125	104	42-H3-100	109	459-5-B	106
408V-6.5-150	104	42-H4-150	109	459-6-C	105
408V-8-175	104	42-H5-150	109	459-6A-C	105
409-0-75	101	42-H6-200	109	459-6B-C	106
409-1-100	101	42-H8-200	109	459-6C-C	106
409-1-25	101	420-3-1	113	459V-3-1	105
409-1-250	101	427411	110	459V-6-C	108
409-2-125	101	429-03-1	111	46-8-F	114
409-2-25	101	429-04-1	111	46-9-H	114
409-2-300	101	429-10-1	111	46-T10-100	109
409-3-150	101	42B-6-B	109	46-T15-150	109
409-4-200	101	42B-H10-200	109	46-T20-150	109
409V-0-100	104	42B-H3-100	109	46-T25-150	109
409V-1-150	104	42B-H4-150	109	46-T30-200	109
409V-2-175	104	42B-H5-150	109	46-T40-200	109
409V-3-200	104	42B-H6-200	109	461-6-B	111
413-0-75	101	42B-H8-200	109	47-00-1	116
413-1-100	101	45-00-1	114	47-01-1	116
413-1-25	101	45-01-1	114	47-02-1	116
413-2-125	101	45-02-1	114	47-03-1	116
413-2-25	101	45-03-1	114	47-04-1	116
413-3-150	101	45-04-1	114	47-05-1	116
413-4-200	101	45-05-1	114	47-06-1	116
413V-0-100	104	45-06-1	114	47-08-1	116
413V-1-150	104	45-08-1	114	47-10-1	116
413V-2-175	104	45-10-1	114	470-10.0-1	128
413V-3-200	104	454-8-F	118	470-12.0-1	128
414-10-75	102	454-9-H	118	470-14.0-1	128
414-15-100	102	454091	118	470-5.5-1	128
414-20-100	102	454101	118	470-6.5-1	128
414-25-125	102	454151	118	470-8.0-1	128
414-27-125	102	454201	118	470-H10-1	128
414-30-150	102	454251	118	470-H4-1	128
414-40-150	102	454271	118	470-H5-1	128
414-45-150	102	454301	118	470-H6-1	128
414-5-75	102	454401	118	470-H7-1	128
414-6-75	102	457-10-1	117	470-H8-1	128

☪	📖	☪	📖	☪	📖
470-PH1-1	128	475-50T40-1	121	475-TR25-1	122
470-PH2-1	128	475-50T6-1	121	475-TR27-1	122
470-PH3-1	128	475-50T8-1	121	475-TR30-1	122
470-PH4-1	128	475-6.0-1	119	475-TR40-1	122
470-T20-1	128	475-6.5-1	119	475A-25-1	125
470-T25-1	128	475-61-1	127	475A-50-1	125
470-T27-1	128	475-70-3.0-1	119	475A-50-1/2-1	125
470-T30-1	128	475-70-3.5-1	119	475A-60QR-1	125
470-T40-1	128	475-70-5.5-1	119	475A-75QR-1	125
470-T45-1	128	475-70-6.5-1	119	475A-M-150-1	125
470-T50-1	128	475-70PH1-1	119	475A-M-50-1	125
470-T55-1	128	475-70PH2-1	119	475A-M-75-1	125
470011	129	475-70PH3-1	119	475D-PH1-1	123
470051	129	475-70PZ1-1	121	475D-PH2-1	123
471-18-1	127	475-70PZ2-1	121	475D-PH3-1	123
471011	129	475-70PZ3-1	121	475D-PZ1-1	123
471151	132	475-8.0-1	119	475D-PZ2-1	123
474M-1/4-1	124	475-89PH1-1	120	475D-PZ3-1	123
474M-10-1	124	475-89PH2-1	120	475R-1/4-110	103
474M-11-1	124	475-89PH3-1	120	475R-1/4-30	103
474M-12-1	124	475-89PZ1-1	121	475T-PH1-1	123
474M-13-1	124	475-89PZ2-1	121	475T-PH2-2	123
474M-3/8-1	124	475-89PZ3-1	121	475T-PH3-2	123
474M-5-H	124	475-89T10-1	122	475T-PZ1-1	123
474M-5.5-1	124	475-89T15-1	122	475T-PZ2-2	123
474M-6-1	124	475-89T20-1	122	475T-PZ3-2	123
474M-7-1	124	475-89T25-1	122	478-4-1	111
474M-8-1	124	475-89T27-1	122	478-4-2	111
474M-9-1	124	475-89T30-1	122	48-9-H	116
474MR-10-1	124	475-89T40-1	122	48-9C-H	113
474MR-8-1	124	475-9-1	127	48A-13-H	116
475-1/4-125	102	475-H3-1	122	5-100-1	36
475-1/4F-160	102	475-H4-1	122	5-100-2	36
475-150PH1-1	120	475-H5-1	122	5-100C-1	36
475-150PH2-1	120	475-H6-1	122	5-150-1	36
475-150PZ1-1	121	475-PH0-1	119	5-150-2	36
475-150PZ2-1	121	475-PH1-1	119	5-150C-1	36
475-150T10-1	122	475-PH2-1	119	5-200-1	36
475-150T15-1	122	475-PH2G-1	120	5-200-2	36
475-150T20-1	122	475-PH3-1	119	5-200C-1	36
475-150T25-1	122	475-PZ0-1	120	5-250-1	36
475-150T30-1	122	475-PZ1-1	120	5-250-2	36
475-150T40-1	122	475-PZ2-1	120	5-250C-1	36
475-32-1	126	475-PZ3-1	120	5-300-1	36
475-32-8Disp	126	475-T10-1	121	5-300-2	36
475-32A-1	126	475-T15-1	121	5-300C-1	36
475-4-1	119	475-T20-1	121	5-375-2	36
475-4.5-1	119	475-T25-1	121	5-375C-2	36
475-5-1	110	475-T27-1	121	5-4-W	36
475-5.5-1	119	475-T30-1	121	5-450-2	36
475-50PH1-1	119	475-T40-1	121	5-450C-2	36
475-50PH2-1	119	475-T45-1	121	5-STB-12DISP	37
475-50PH3-1	119	475-T5-1	121	500-240-1	134
475-50PZ1-1	120	475-T50-1	121	501-150-1	134
475-50PZ2-1	120	475-T6-1	121	501-175-1	134
475-50PZ3-1	120	475-T7-1	121	501-200-1	134
475-50T10-1	121	475-T8-1	121	501-250-1	134
475-50T15-1	121	475-T9-1	121	501-300-1	134
475-50T20-1	121	475-TR10-1	122	502-230-1	134
475-50T25-1	121	475-TR15-1	122	503-200-1	138
475-50T30-1	121	475-TR20-1	122	503-250-1	138

Q	■	Q	■	Q	■
503-300-1	138	514-005-1	135	520-61-2	139
504-150-1	134	514-006-1	135	520-63-2	139
504-175-1	134	515-002-1	136	521-51-2	139
504-200-1	134	515-003-1	136	521-52-2	139
504-250-1	134	515-004-1	136	521-53-2	139
504-300-1	134	515-005-1	136	521-54-2	139
505-150-1	134	515-006-1	136	521-71-2	139
505-200-1	134	515-007-1	136	521-73-2	139
505-250-1	134	515-008-1	136	521-81-2	139
506-150-1	134	515-009-1	136	521-82-2	139
506-175-1	134	515-010-1	136	521-83-2	139
506-200-1	134	515-91-4	137	521-84-2	139
51-06-1	46	516-002-1	136	522-21-2	140
51-07-1	46	516-003-1	136	522-22-2	140
51-08-1	46	516-004-1	136	522-23-2	140
51-09-1	46	516-005-1	136	522-31-2	140
51-10-1	46	516-006-1	136	522-32-2	140
51-11-1	46	516-008-1	136	522-33-2	140
51-12-1	46	517-120-1	137	522-41-2	140
51-13-1	46	517-130-1	137	522-42-2	140
51-14-1	46	517-135-1	137	522-43-2	140
51-15-1	46	517-140-1	137	525-11-2	140
51-16-1	46	517-145-1	137	525-12-2	140
51-17-1	46	517-150-1	137	525-21-2	140
51-18-1	46	517-91-4	137	525-22-2	140
51-19-1	46	518-004-1	137	525-31-2	140
51-20-1	46	518-006-1	137	525-32-2	140
51-21-1	46	519-91-4	136	525-41-2	140
51-22-1	46	519-92-4	137	525-42-2	140
51-23-1	46	519-93-4	138	525-43-2	140
51-24-1	46	52-06-1	46	525-61-2	140
51-25-1	46	52-07-1	46	525-62-2	140
51-26-1	46	52-08-1	46	525-71-2	140
51-27-1	46	52-09-1	46	525-72-2	140
51-28-1	46	52-10-1	46	525-81-2	140
51-29-1	46	52-11-1	46	525-82-2	140
51-30-1	46	52-12-1	46	525-91-2	140
51-32-1	46	52-13-1	46	525-92-2	140
51-8-W	46	52-14-1	46	526-31-2	141
511-100-1	135	52-15-1	46	526-32-2	141
511-105-1	135	52-16-1	46	526-41-2	141
511-110-1	135	52-17-1	46	526-42-2	141
511-115-1	135	52-18-1	46	526-51-2	141
511-130-1	135	52-19-1	46	526-52-2	141
511-91-4	135	52-20-1	46	526-53-2	141
511-92-4	135	52-21-1	46	526-61-2	141
511501	138	52-22-1	46	526-62-2	141
512-010-1	135	52-23-1	46	526-71-2	141
512-012-1	135	52-24-1	46	526-72-2	141
513-002-1	135	52-25-1	46	526-91-2	141
513-003-1	135	52-26-1	46	526-92-2	141
513-004-1	135	52-27-1	46	527-31-2	141
513-005-1	135	52-28-1	46	527-32-2	141
513-006-1	135	52-29-1	46	527-33-2	141
513-008-1	135	52-30-1	46	527-41-2	141
513-010-1	135	52-32-1	46	527-43-2	141
513-91-4	136	52-8-W	46	527-51-2	141
513-92-4	136	520-13S-1	139	527-52-2	141
514-002-1	135	520-41-2	139	527-53-2	141
514-003-1	135	520-42-2	139	527-61-2	141
514-004-1	135	520-43-2	139	527-63-2	141

Q	Q	Q
527-71-2	534401	560-LD-12
527-73-2	534411	560-LD-14
527-81-2	534501	601-160-1
527-82-2	534521	601-180-1
527-83-2	534531	601-200-1
527-91-2	534541	601-3-C
527-93-2	534551	601911
529021	534561	601M-125-1
529031	534571	601V-160-1
529041	534601	601V-180-1
529061	534611	601V-200-1
529071	534621	601V-3-C
529081	534681	602-3-C
529091	534691	604-160-1
529101	534701	604-180-1
529151	534901	604M-125-1
529161	534911	604V-160-1
529171	534931	608-160-1
529181	534941	612-160-1
529191	536011	612-200-1
529251	538-140-1	612M-125-1
529261	540021	612V-160-1
529271	540031	612V-200-1
529291	540041	613-160-1
529611	540051	613-200-1
529621	540061	613V-160-1
529631	540071	613V-200-1
529701	540081	621551
529711	540091	621561
529721	540101	621571
529751	540121	621581
529761	546-265-1	621591
529771	546-265-4	621651
529781	546-265-A	621661
529791	546-265-B	621671
529801	546021	621681
529811	546201	621691
529821	546211	621751
530-03-2	546221	621761
530-05-2	546251	621771
530-07-2	548-275-1	621781
530-13-2	548-275-M3	621791
530-15-2	548-275-M4	621851
531-05-2	548-275-M5	621861
531-07-2	548-275-M6	621871
531-08-2	549-230-2	621881
531-09-2	550-80-4	621891
531-15-2	560-41-1	624-140-1
531-17-2	560-BN-15	624-160-1
531-18-2	560-CA-10	624-180-1
531-19-2	560-CA-12	624M-125-1
534251	560-CA-14	624V-140-1
534261	560-HD-06	624V-160-1
534281	560-HD-08	625-180-1
534291	560-HD-10	625-200-1
534311	560-HD-12	625V-180-1
534321	560-HD-14	626M-125-1
534341	560-HT-1	629-160-1
534351	560-LD-06	629V-160-1
534371	560-LD-08	630-61B1-4
534381	560-LD-10	630-B1-1

Q		Q		Q	
630-B2-1	150	670-178-1	160	716-M14-1	166
630-B3 -1	150	671-150-1	160	716-M18-1	166
631-200-1	153	672-220-1	159	716-M6-1	166
632-220-1	153	701-130-1	164	716-M8-1	166
632-250-1	153	701-130-B	164	718211	166
632-280-1	153	701-160-1	164	718231	166
632D-250-1	153	701-160-B	164	720-1M-413	167
634-200-1	147	701-160-K	164	720-3M-413	167
634-250-1	147	701-160-K	164	720-LM-1	167
634-300-1	147	701-160-S	164	720031	167
634Q-250-1	147	701-160-S	164	722-4-1	161
634V-250-1	152	701-200-1	164	730011	166
645011	157	701-200-B	164	730131	166
645021	157	701-250-1	164	7309-1-10	52
645031	157	701-250-B	164	7309-1-11	52
645041	157	701-250-K	164	7309-1-12	52
647-235-1	157	701-250-K	164	7309-1-13	52
647-250-1	157	701-250-S	164	7309-1-14	52
648-140-1	157	701-250-S	164	7309-1-17	52
648-165-1	157	701-350-1	164	7309-1-19	52
648-185-1	157	701-350-B	164	7309-1/2	53
648-250-1	157	701-90-1	164	7309-1/4	53
648-4-W	157	701-90-B	164	7309-125	52
64A-190-1	155	701-90-K	164	7309-2-10	52
64A-235-1	155	701-90-K	164	7309-2-11	52
64B-190-1	155	701-90-S	164	7309-2-12	52
64B-235-1	155	701-90-S	164	7309-2-13	52
64C-300-1	156	702-40-1	164	7309-2-14	52
64CA-175-1	156	702-40-K	164	7309-2-17	52
64CA-300-1	156	702-40-K	165	7309-2-19	52
64CA-450-1	156	702-40-P	164	7309-2-22	52
64CAD-300-1	156	702-40-P	165	7309-3/8	53
64L-165-1	156	702-40-S	164	7309-30	52
64T-300-1	156	702-40-S	165	7309-60	52
64W-300-1	156	702-65-1	164	7314-1-13	53
651101	153	702-65-K	164	7314-1-14	53
651111	153	702-65-K	165	7314-1-17	53
651121	153	702-65-S	164	7314-1-19	53
651131	153	702-65-S	165	7314-1-22	53
651141	153	702-80-1	164	7314-1-24	53
651201N	153	702-80-K	164	7314-1-27	53
651211N	153	702-80-K	165	7314-1-30	53
651221N	153	702-80-S	164	7314-1-32	53
651231N	153	702-80-S	165	7314-1/2	53
651241N	153	703-40-1	165	7314-2-13	53
655-160-1	149	703-40-B	164	7314-2-14	53
655-200-1	149	703-40-B	165	7314-2-17	53
658-250-1	155	703-65-1	165	7314-2-19	53
659-250-1	155	703-80-1	165	7314-2-22	53
660-250-1	155	71-UN7-1	49	7314-2-24	53
661-140-1	161	71-UN9-1	49	7314-2-27	53
661-140-12-DISP	161	713001	165	7314-2-30	53
661051	161	713011	165	7314-2-32	53
661061	161	713511	165	7314-2-36	53
664-200-1	160	713521	165	7314-2-41	53
665-200-1	160	713531	165	7314-200	52
666-156-1	159	713541	165	7314-335	52
667-135-1	159	713611	165	740-016-2	168
668-150-1	159	716-5-1	166	740-020-2	168
669-175-1	159	716-8-1	166	740-022-2	168
669-190-1	160	716-M11-1	166	740-025-2	168

Q		Q		Q	
740-030-2	168	9022-1-19HB	30	980HV-3-1	176
740-035-2	168	9022-2-16HB	30	980HV-5-1	176
740-040-2	168	9022-2-16HBTS2	31	981-1000-1	174
740-050-2	168	9022-2-19HB	30	981-1200-1	174
740S-008-2	168	9022-3-10	34	981-1500-1	174
740S-010-2	168	9022-3-20	33	981-1800-1	174
740S-012-2	168	9022-3-20TS1	33	981-2000-1	174
740S-014-2	168	9022-3-20TS2	33	981-400-1	174
796491	165	9022-3-30	33	981-400M-1	174
796501	165	9022-3-30TS1	33	981-600-1	174
796511	165	9022-3-30TS2	33	981-600M-1	174
796521	165	9022-3-40	34	981-800-1	174
796531	165	9022-3-40TS1	34	981-SET	174
796541	165	9022-3-40TS2	34	982-10-1	175
796551	165	9022-3-50	34	982-40-1	174
796561	165	9022-3-50TS1	34	982-4M-1	174
796571	165	9022-4-26	32	982-60-1	174
800-111-1	171	9022-4-26TS1	32	982-6M-1	174
800-131-1	170	9022-4-35	32	982-80-1	174
800-141-1	171	9022-4-35TS1	32	982-SET	174
800-151-1	171	9022-BP1	31	982-TOR-1	175
800-168-1	170	9022-BPW	31	983-25-1	175
800-208-1	170	9023PT565	29	984-6-1	178
800-228-1	170	9023PT565TS1	29	984-6D-1	178
801-011-1	172	9024-1TS1	28	985-2-1	177
801-041-1	171	9024-1TS145	28	991-200-1	177
801-145-1	172	9063FT90	25	991-250-1	177
801101	171	9063HT150	25	991-300-1	177
802-2400-1	170	9063HT300	25	991-400-1	177
802-2423-1	170	9064-15	14	993-150-1	177
802-2451-1	170	9064AC01	14	993-300-1	177
802-3000-1	170	9064K-02	25	993-400-1	177
802-3023-1	170	9064K-02T	25	CEE-COUNT-IR-1	191
802-3051-1	170	9065K4	14	IFF1A001	18
802-3600-1	170	9066K-01	14	IFF1A002	18
802-3623-1	170	9066K-02	14	IFF1A003	18
802-3651-1	170	9066K-03	14	IFF1A004	19
803-318-5	171	9066K-05	14	IFF1A005	19
803-318-50	171	9066K-06	14	IFF1A006	19
803-324-5	171	9066K5	14	IFF1A007	20
803-324-50	171	9066K6	14	IFF1E001	20
803-332-5	171	9066K6FF100	15	IFF1E002	20
803-332-50	171	9066K6FF101	16	IFF1E003	20
805-3-C	144	9066K7	14	IFF1E004	20
806-6-B	144	9066K7FF102	17	IFF1E005	20
810-2264-4	172	910-152DISP	107	IFF1E006	20
902021	26	910-83DISP	107	IFF1E007	21
902031	26	910V-72DISP	108	IFF1E008	21
9020F350	26	971-13-1	178	IFF1E009	21
9020F550	26	971-20-1	178	IFF1E010	21
9020F550FF95	27	972-52-1	178	IFF1E011	21
9020F550TS10	27	980-20S-1	177	IFF1E012	21
902131	26	980-3-1	175	IFF1E013	22
9021FTW520	24	980-3B-1	175	IFF1E014	22
9021FTW520-AC1	24	980-5-1	175	IFF1E015	22
9021FTW520-AC2	24	980-5-25-1	175	IFF1E016	22
9021FTW520-AC3	24	980-5B-1	175	IFF1E017	22
9021FTW520-AC4	24	980-5T-1	176	IFF1E018	22
9021FTW520-AC5	24	980-5W-1	176	IFF1E019	23
9021FTW520FF1	24	980-8B-1	175	IFF1E021	23
9022-1-16SB	30	980-TP2-1	176	IFF1E023	23

Q	Q	Q
IFF1E024	PQCF14	T49T40H
IFF1E025	T49	T49T40HL
L-ALUM-1	T4901	T49T40L
L-ALUM-12DISP	T4902	T49T40XL
L-BOOK-1	T49H10	T49T45
L-COMP-1	T49H10L	T49T45H
L-FLEX-1	T49H10XL	T49T45HL
L-HEAD-1	T49H12	T49T45L
L-MINI-1	T49H12L	T49T45XL
L-PEN-1	T49H14	T49T50
L-POCK-1	T49H4	T49T50H
L-SLIM-1	T49H4L	T49T50HL
LT-420-1	T49H5	T49T50L
MEE-1S2L-B-I	T49H5L	T49T55
MEE-BANNER-I	T49H6	T49T55H
MEE-COR-1L-B-I	T49H6L	T49T55HL
MEE-COR-LIGHT-I	T49H7	T49T55L
MEE-COUNT-IR-1	T49H7L	T49T55XL
MEE-COUNT-IR-2	T49H8	T49T60
MEE-COUNT-IR-3	T49H8L	T49T60H
MEE-DB-W-NL	T49M10	T49T60HL
MEE-LIGHTBOX-I	T49M10L	T49T60L
MEE-SA-SS-IR	T49M12	T49T70HL
MEE-SIGN-CARR-I	T49M12L	T49T80HL
MEE-TR-W-I	T49M14	WB-300-2
P218	T49M5	WB-500-2
P254	T49M5L	WB-625-2
P255	T49M6	WB-710-2
P700	T49M6L	WB-900-2
P704	T49M8	Z150003
P800	T49M8L	ZH1100
P802	T49SQ10	ZH1101
P815	T49SQ8	ZH1102
P817	T49T20	ZH1103
P821	T49T20H	ZH1104
PEE-COUNT-006	T49T20HL	ZH1105
PEE-METHACRYL-I	T49T20L	ZH1106
PEE-PC-IR-1	T49T25	ZH1107
PEE-SIGN-DB-W-2	T49T25H	ZH1108
PEE-TOPSIGN-I	T49T25HL	ZH1109
PM5002	T49T25L	ZH1110
PM5003	T49T27	ZH1111
PM5012	T49T27H	ZH1112
PM5013	T49T27HL	ZH1113
PM5142	T49T27L	ZH1114
PM5143	T49T30	ZH1115
PM5152	T49T30H	ZH70610
PM5153	T49T30HL	ZH70611
PM5248	T49T30L	ZH70612
PN251	T49T30XL	ZH70613
PPOS-A4-STICK-I	T49T40	ZH70614

inch.		mm.	inch.		mm.	inch.		mm.
inch.		mm.	inch.		mm.	inch.		mm.
.	0.0039	0.1000	.	0.5512	14.0000	.	1.8898	48.0000
.	0.0079	0.2000	9/16"	0.5625	14.2875	.	1.9291	49.0000
.	0.0118	0.3000	.	0.5709	14.5000	.	1.9685	50.0000
1/64"	0.0156	0.3969	37/64"	0.5781	14.6844	2"	2.0000	50.8000
.	0.0157	0.4000	.	0.5906	15.0000	.	2.0079	51.0000
.	0.0197	0.5000	19/32"	0.5938	15.0813	.	2.0472	52.0000
.	0.0236	0.6000	39/64"	0.6094	15.4781	.	2.0866	53.0000
.	0.0276	0.7000	.	0.6102	15.5000	.	2.1260	54.0000
1/32"	0.0313	0.7938	5/8"	0.6250	15.8750	.	2.1654	55.0000
.	0.0315	0.8000	.	0.6299	16.0000	.	2.2047	56.0000
.	0.0354	0.9000	41/64"	0.6406	16.2719	.	2.2441	57.0000
.	0.0394	1.0000	.	0.6496	16.5000	2 1/4"	2.2500	57.1500
.	0.0433	1.1000	21/32"	0.6563	16.6688	.	2.2835	58.0000
3/64"	0.0469	1.1906	.	0.6693	17.0000	.	2.3228	59.0000
.	0.0472	1.2000	43/64"	0.6719	17.0656	.	2.3622	60.0000
.	0.0512	1.3000	11/16"	0.6875	17.4625	.	2.4016	61.0000
.	0.0551	1.4000	.	0.6890	17.5000	.	2.4409	62.0000
.	0.0591	1.5000	45/64"	0.7031	17.8594	.	2.4803	63.0000
1/16"	0.0625	1.5875	.	0.7087	18.0000	2 1/2"	2.5000	63.5000
.	0.0630	1.6000	23/32"	0.7188	18.2563	.	2.5197	64.0000
.	0.0669	1.7000	.	0.7283	18.5000	.	2.5591	65.0000
.	0.0709	1.8000	47/64"	0.7344	18.6531	.	2.5984	66.0000
.	0.0748	1.9000	.	0.7480	19.0000	.	2.6378	67.0000
5/64"	0.0781	1.9844	3/4"	0.7500	19.0500	.	2.6772	68.0000
.	0.0787	2.0000	49/64"	0.7656	19.4469	.	2.7165	69.0000
.	0.0827	2.1000	.	0.7677	19.5000	2 3/4"	2.7500	69.8500
.	0.0866	2.2000	25/32"	0.7813	19.8438	.	2.7559	70.0000
.	0.0906	2.3000	.	0.7874	20.0000	.	2.7953	71.0000
3/32"	0.0938	2.3813	51/64"	0.7969	20.2406	.	2.8346	72.0000
.	0.0945	2.4000	.	0.8071	20.5000	.	2.8740	73.0000
.	0.0984	2.5000	13/16"	0.8125	20.6375	.	2.9134	74.0000
7/64"	0.1094	2.7781	.	0.8268	21.0000	.	2.9528	75.0000
.	0.1181	3.0000	53/64"	0.8281	21.0344	.	2.9921	76.0000
1/8"	0.1250	3.1750	27/32"	0.8438	21.4313	3"	3.0000	76.2000
.	0.1378	3.5000	.	0.8465	21.5000	.	3.0315	77.0000
9/64"	0.1406	3.5719	55/64"	0.8594	21.8281	.	3.0709	78.0000
5/32"	0.1563	3.9688	.	0.8661	22.0000	.	3.1102	79.0000
.	0.1575	4.0000	7/8"	0.8750	22.2250	.	3.1496	80.0000
11/64"	0.1719	4.3656	.	0.8858	22.5000	.	3.1890	81.0000
.	0.1772	4.5000	57/64"	0.8906	22.6219	.	3.2283	82.0000
3/16"	0.1875	4.7625	.	0.9055	23.0000	.	3.2677	83.0000
.	0.1969	5.0000	29/32"	0.9063	23.0188	.	3.3071	84.0000
13/64"	0.2031	5.1594	59/64"	0.9219	23.4156	.	3.3465	85.0000
.	0.2165	5.5000	.	0.9252	23.5000	.	3.3858	86.0000
7/32"	0.2188	5.5563	15/16"	0.9375	23.8125	.	3.4252	87.0000
15/64"	0.2344	5.9531	.	0.9449	24.0000	.	3.4646	88.0000
.	0.2362	6.0000	61/64"	0.9531	24.2094	3 1/2"	3.5000	88.9000
1/4"	0.2500	6.3500	.	0.9646	24.5000	.	3.5039	89.0000
.	0.2559	6.5000	31/32"	0.9688	24.6063	.	3.5433	90.0000
17/64"	0.2656	6.7469	.	0.9843	25.0000	.	3.5827	91.0000
.	0.2756	7.0000	63/64"	0.9844	25.0031	.	3.6220	92.0000
9/32"	0.2813	7.1438	1"	1.0000	25.4000	.	3.6614	93.0000
.	0.2953	7.5000	.	1.0039	25.5000	.	3.7008	94.0000
19/64"	0.2969	7.5406	.	1.0236	26.0000	.	3.7402	95.0000
5/16"	0.3125	7.9375	.	1.0433	26.5000	.	3.7795	96.0000
.	0.3150	8.0000	.	1.0630	27.0000	.	3.8189	97.0000
21/64"	0.3281	8.3344	.	1.0827	27.5000	.	3.8583	98.0000
.	0.3346	8.5000	.	1.1024	28.0000	.	3.8976	99.0000
11/32"	0.3438	8.7313	.	1.1220	28.5000	.	3.9370	100.0000
.	0.3543	9.0000	.	1.1417	29.0000	4"	4.0000	101.6000
23/64"	0.3594	9.1281	.	1.1614	29.5000	.	4.3307	110.0000
.	0.3740	9.5000	.	1.1811	30.0000	4 1/2"	4.5000	114.3000
3/8"	0.3750	9.5250	.	1.2205	31.0000	.	4.7244	120.0000
25/64"	0.3906	9.9219	1 1/4"	1.2500	31.7500	5"	5.0000	127.0000
.	0.3937	10.0000	.	1.2598	32.0000	.	5.1181	130.0000
13/32"	0.4063	10.3188	.	1.2992	33.0000	.	5.5118	140.0000
.	0.4134	10.5000	.	1.3386	34.0000	.	5.9055	150.0000
27/64"	0.4219	10.7156	.	1.3780	35.0000	6"	6.0000	152.4000
.	0.4331	11.0000	.	1.4173	36.0000	.	6.2992	160.0000
7/16"	0.4375	11.1125	.	1.4567	37.0000	.	6.6929	170.0000
.	0.4528	11.5000	.	1.4961	38.0000	.	7.0866	180.0000
29/64"	0.4531	11.5094	1 1/2"	1.5000	38.1000	.	7.4803	190.0000
15/32"	0.4688	11.9063	.	1.5354	39.0000	.	7.8740	200.0000
.	0.4724	12.0000	.	1.5748	40.0000	8"	8.0000	203.2000
31/64"	0.4844	12.3031	.	1.6142	41.0000	.	9.8425	250.0000
.	0.4921	12.5000	.	1.6535	42.0000	10"	10.0000	254.0000
1/2"	0.5000	12.7000	.	1.6929	43.0000	20"	20.0000	508.0000
.	0.5118	13.0000	.	1.7323	44.0000	30"	30.0000	762.0000
33/64"	0.5156	13.0969	1 3/4"	1.7500	44.4500	40"	40.0000	1016.0000
17/32"	0.5313	13.4938	.	1.7717	45.0000	60"	60.0000	1524.0000
.	0.5315	13.5000	.	1.8110	46.0000	80"	80.0000	2032.0000
35/64"	0.5469	13.8906	.	1.8504	47.0000	100"	100.0000	2540.0000

STANDARDS

What is a standard?

A standard is a document that provides requirements, specifications, guidelines or characteristics that can be used consistently to ensure that materials, products, processes and services are fit for their purpose.

What are the benefits of ISO International Standards?

ISO International Standards ensure that products and services are safe, reliable and of good quality. For business, they are strategic tools that reduce costs by minimizing waste and errors, and increasing productivity. They help companies to access new markets, level the playing field for developing countries and facilitate free and fair global trade.

IRIMO main product families

Socket wrenches

- ISO 2725, hand sockets, general dimensions; ISO 1174, driving squares. The standards define the limits to certain dimensions to avoid the play between the socket and the bolt, the accessibility to reach, and guarantee the correct torque transmission and to work with nuts and studs.
- ISO 1711, hand and impact sockets, define the minimum hardness that a socket should have, and the minimum torque that a socket should resist. This assures that only the right material has been used, and the socket will be able to be used without breakage risk.
- The profile of the sockets, hex and biex, was designed for a much better distribution of the strength far from the corners to avoid possible breakings. At the same time the transmission of the torque to the bolts and nuts is made out of the edges, protecting the life of the components.

Adjustable Wrenches

- Stands ISO 6787 standard torque values plus 30% without opening and deformation.
- General dimensions of adjustable wrenches according to ISO 6787 standard.
- Design forged in one piece.

Spanners-Wrenches

- Stands ISO 1711-1 standard torque values plus 30% without opening and deformation.
- Higher hardness according to ISO 1711-1, without fragility risk.
- Wrench end fitting tolerance according to ISO 691 gives higher performance and better transmission of the torque to the bolts and nuts.

Pliers

- ISO standards on pliers define, for each product family, the basic dimensions of the product. In addition to this, when applicable ISO standards also define:
 - Maximum acceptable deformations after a load test.
 - Maximum acceptable deformations after a torsion test.
 - Maximum acceptable cutting force tests.
 - The most important ISO standards for pliers are:
 - ISO 5745 Pliers for gripping and manipulating – Dimensions and test values.
 - ISO 5746 Engineer's and "Lineman's" pliers – Dimensions and test values.
 - ISO 5749 Diagonal cutting nippers – Dimensions and test values.
 - ISO 8976 Multiple slip joint pliers – Dimensions and test values.
 - ISO 9242 Construction worker's pincers – Dimensions and test values.
 - ISO 9243 Pliers and nippers – Carpenter's pincers – Dimensions and test values.

Torque wrenches

ISO 6789 classifies the torque wrenches into different types (I, II) and classes (A, B, C, D, E, F).

The ISO standard assigns different accuracy levels (4% or 6%) depending on the type, class and max torque of each wrench.

This accuracy needs to be accomplished between 20% and 100% of the maximum torque of the wrench.

The standard also establishes the calibration procedure, conditions and frequency as well as other tests and product requirements.

IRIMO torque tools comply with ISO 6789 standard and SNA Europe offers calibration services in his internal After Sales Centers.

Screwdrivers

ISO standards on screwdrivers define the tip dimension, the minimum hardness and the minimum torque that they should resist.

After torque testing with the minimum value, screwdrivers shall not show any deformation or injuries at the tip:

- ISO 2380 Slotted screwdrivers – Dimensions, hardness and minimum torque values.
- ISO 8764 Phillips and Pozidriv screwdrivers – Dimensions, hardness and minimum torque values.
- ISO 2936 Hexagon screwdrivers – Dimensions, hardness and minimum torque values.

However, the IRIMO screwdrivers must meet Internal Standards that are above the ISO standard.

Internal torque values standards is 20% over the ISO standard for Slotted screwdrivers and 50% in Phillips and Pozidriv screwdrivers.

The combination of the raw material and hardness determines the performance of the blade, longer life and quality work Internal hardness; Minimum SNA Europe 58-59 HRc. Minimum ISO standards 54 HRc. TORX® drivers; torque values are evaluated with testing gauges of Acument Global Technologies Inc., licensor of TORX®.

SNA Europe is committed to providing its customers with products that are fully compliant with all regulations, international protocols and customer standards to which they are subject. In this respect, SNA Europe complies with appropriate international regulations and directives, including REACH, RoSH, WEEE, C€ Conflict Minerals, etc.

Regarding REACH European regulation N° 1907/2006, it requires suppliers of any product to inform the customer of the presence of substances of very high concern (SVHC) (<http://www.echa.europa.eu/candidate-list-table>) listed in the relevant and official list above a concentration of 0.1% weight by weight (w/w). The ECHA, European Chemicals Agency, recently added several chemical substances to the list and as of December, 2014 there are 161 substances in the Candidate List of SVHC. The compliance in REACH prevents the user from probable serious effects to human health (and/or) the environment, including carcinogenic, toxic and mutagenic categories.

The definition and aim of the RoHS directive is quite simple. The RoHS directive aims to restrict certain dangerous substances commonly used in electronic and electronic equipment. Any RoHS compliant component is tested for the presence of Lead (Pb), Cadmium (Cd), Mercury (Hg), Hexavalent chromium (Hex-Cr), Polybrominated biphenyls (PBB), and Polybrominated diphenyl ethers (PBDE).

The Waste Electrical and Electronic Equipment Directive (WEEE Directive) is the European Community directive 2012/19/EU on waste electrical and electronic equipment (WEEE) which, together with the RoHS Directive 2002/95/EC, became European Law in February 2003. The WEEE Directive set collection, recycling and recovery targets for all types of electrical goods, with a minimum rate of 4 kilograms per head of population per annum recovered for recycling by 2009.

The C€ marking is the manufacturer's declaration that the product meets the requirements of the applicable EU directives.

The term Conflict Minerals refers to raw materials that come from a particular part of the world where conflict is occurring and affects the mining and trading of those materials. These are defined as columbite-tantalite, also known as coltan (from which tantalum is derived); cassiterite (tin); gold; wolframite (tungsten); or their derivatives; to be financing conflict in the Democratic Republic of the Congo or an adjoining country.

SNAEurope

For warranty info
please check your local website
www.irimo.com

CONTACT US

Argentina

A.M. de Justo 1750 3° A
C1107AFJ - Capital Federal
Buenos Aires
Tel: +54 (11) 4313-1004
Fax: +54 (11) 4893-3553

Australia

3 Cooper Street, Smithfield,
NSW 2164
Tel: +61 (0) 2 8787 5700
Fax: +61 (0) 2 9756 6130

Беларусь

ЗАО "Эс-Эн-Эй Европа Индастриз Бисов"
220075 СЭЗ "Минск"
ул. Селицкого, д. 8А
Телефон +375 (17) 389 79 50
info.by@snaeurope.com

Belgium**Branch of SNA Europe (Benelux) BV**

De Kleetlaan 12A Pegasus Park
1831 DIEGEM
Tel: +32 (0)2 726 03 03
Fax: +32 (0)2 726 04 36

Chile

Av. Americo Vespucio 2760-D
Conchali - Santiago - Chile
Tel: +56 2 623 0203
Fax: +56 2 623 5395

Česká republika**SNA Europe s.r.o.**

Holadnská 2/4
639 00 Brno
Tel: +420 537 022 520
Fax: +420 537 022 200

Danmark

Vallensbækvej 40,
2605 Brøndby
Tel: +45 4363 0330
Fax: +45 4396 2456

Deutschland

Willetstraße 10
40822 Mettmann
Tel: +49 (0) 2104 833 83 0
Fax: +49 (0) 2104 833 83 7999

España

c/ Hilanderas, 1
(P.O. Box / Apdo de Correos nº 5)
C.P. 20303 Irún
Tel: +34 902 235 100 / +34 943 649 111
Fax: +34 943 649 120

Ελλάδα

Λ. Βουλιαγμένης 604Γ
167 77 Ελληνικό, Αθήνα
Τηλ: +30 210 9914263
Fax: +30 210 9914587

Export

Antigua Carretera de Altube Km 5,5
P.O.Box 307
01080 VITORIA (Spain)
Tel: +34 945269711
Fax: +34 945165040

France

ZAC de l'Hoirie
20 rue Charles Lacretelle
CS 60101
49072 Beaucouzé cedex
Tél: +33 (0) 2 41 22 98 40
Fax: +33 (0) 2 41 22 98 50

Italia

SNA EUROPE Italia S.p.A.
Via Georges Bizet, 13/15
20092 Cinisello Balsamo MI - Italia
Tel: +39 02 3024161
info.it@snaeurope.com

Казахстан

050000, Алматы,
ул.Шевченко 1656/72г, оф.217
Тел/факс +7 727323 63 39

Nederland

Vossenbeemd 113
5705 CL Helmond
Tel: +31 (0) 492 58 23 82
Fax: +31(0) 492 58 23 20

New Zealand

Unit 3/25 Highbrook Drive
East Tamaki
Auckland
Tel: +64 9-273 46 50
Fax: +64-9-273-2453

Norge

Box 800
1306 Sandvika
Tel: +47 40 49 66 00
Fax: +47 67 17 56 51

Österreich

Vienna, Nineteen, Mooslackengasse 17
A - 1190 Wien
Tel: +49 (0) 2104 8 33 83 0
Fax: +49 (0) 2104 833 83 79 99

Polska

ul. Marynarska 15
02-674 Warszawa
Tel.: +48 (0) 22 6070510
Fax: +48 (0) 22 6070521

Россия

ООО "Эс-Эн-Эй Юроп (РУС)"
141407 г. Химки
ул. Панфилова вл.21, стр.1
Телефон +7 (495) 221 58 51
info.ru@snaeurope.com

Portugal**SNA Europe [Industries] LDA**

R. Maria Julia M. Ramos - Junqueira
4480-254 Vila Do Conde
Tel. +351 252 650 131
Fax. +351 252 650 160

Slovenská republika**SNA Europe s.r.o.**

Karadžičova 8/A
821 08 Bratislava
Tel: +421 (0)2 5939 6124
Fax: +421 (0)2 5939 6217

SRBIJA**Vermax-alati doo**

Ul. Drage Spasić 35
11000 Beograd
Tel: +381 11 2360 500
Tel: +381 11 2360 900
Fax: +381 11 2361 147
e-mail: office@vermax.rs

Suomi**SNA Europe Oy**

PL 6580
00002 Helsinki
Finland
Tel: +358 207 433 510
Fax: +358 207 433 525

Sverige**SNA Europe Industries AB**

Box 83
SE-745 22 Enköping
Tel: +46 (0) 171-47 82 00
Fax: +46 (0) 171-47 82 38

Schweiz / Suisse

Willetstraße 10
40822 Mettmann
Tel: +49 (0) 2104 833 83 0
Fax: +49 (0) 2104 833 83 7999

Türkiye

Girne Mah. Maltepe Küçük San. Sitesi
F Blok No:19 Maltepe
Istanbul
Tel: +90 (0) 216 367 10 21
Fax: +90 (0) 216 367 11 71

Украина

«Бахко Бисов Свенска Акциеболаг»
SNA Europe [Ukraine & Moldova]
Телефон +38 067 441 16 09
офис 555, улица Армянская, 6А
Киев, Украина

United Kingdom

Moorhead Way, Bramley,
Rotherham, South Yorkshire S66 1YY
Tel: +44 (0) 1709 731731
Fax: +44 (0) 1709 731741

NOTES:

NOTES

The page contains a writing area with 23 horizontal grey lines. A thick, vibrant yellow brushstroke runs across the top of the page, just below the 'NOTES' header.



IRIMO

www.irimo.com

IRIM022-ENG-NOP



8 414909 246384

SNA Europe